

Installation Guide V1.1

DUET AD



Motor Power Company s.r.l.

Via Leonardo Da Vinci, 4
42024 Castelnuovo Sotto Reggio Emilia - Italia
Tel. +39 0522 682710 - Fax +39 0522 683552
info@motorpowerco.it - motorpowerco.com
Cap. Soc. 250.000,00€ i.v. - R.E.A. di RE 175521
Iscr.Reg.Impr. di RE n.01308390358 - N. Mecc. RE 010210
C.F. e P.IVA IT 01308390358

**MOTOR
POWER**
COMPANY

1 Index

1	Index	2
2	About this document	4
3	General Description	4
3.1	DUET AD	4
3.2	Proper use	5
3.3	Standards and guidelines	5
4	Safety instructions.....	6
5	Technical data, accessories	7
5.1	Electrical data.....	7
5.2	Mechanical data	7
5.3	Dimensions	8
5.4	DUET AD 1,5 03	8
5.5	DUET AD 2,8 02	9
5.6	Accessories	9
6	Protective functions.....	10
6.1	Ballast circuit.....	10
6.2	Current limitation.....	10
7	Installation	11
8	Mechanical assembly	11
8.1	EMI compatibility.....	11
8.2	Ground wire.....	12
8.3	Motor power supply	13
8.4	Signal interface supply	15
8.5	Schematic circuit of the digital inputs	16
8.6	Schematic circuit of the digital outputs	17
8.7	Maximum cable length and power supply.....	18
9	Connection schematic.....	18
9.1	Schematic circuit for power supply controller	19
9.2	Connection motor power supply.....	20

Motor Power Company s.r.l.

Via Leonardo Da Vinci, 4
 42024 Castelnovo Sotto Reggio Emilia - Italia
 Tel. +39 0522 682710 - Fax +39 0522 683552
 info@motorpowerco.it - motorpowerco.com
 Cap. Soc. 250.000,00€ i.v. - R.E.A. di RE 175521
 Iscr.Reg.Impr. di RE n.01308390358 - N. Mecc. RE 010210
 C.F. e P.IVA IT 01308390358



9.3	Connection signal interface supply	21
9.4	Can Open connection Interface.....	21
10	Maintenance & Service	22
10.1	Maintenance, taking out of service and disposal	22
10.2	Service & Support.....	23

Notice:

This guide delivered subject to the following conditions and restrictions: This guide contains proprietary information belonging to Motor power Company Srl. Such information is supplied solely for the purpose of assisting users of the DUET AD in its installation and configuration.

The text and graphics included in this manual are for the purpose of illustration and reference only. The specifications on which they are based are subject to change without notice.

Motor power Company and the Motor power Company logo are trademarks of Motor power Company Srl.

Information in this document is subject to change without notice.

Version	Date	Author	Note
1.0	15/07/2020	Maurizio Piccinelli	Initial Release
1.1	01/09/2020	Roberto Nicolini	Major Updates



Motor Power Company s.r.l.

Via Leonardo Da Vinci, 4
42024 Castelnovo Sotto Reggio Emilia - Italia
Tel. +39 0522 682710 - Fax +39 0522 683552
info@motorpowerco.it - motorpowerco.com
Cap. Soc. 250.000,00€ i.v. - R.E.A. di RE 175521
Iscr.Reg.Impr. di RE n.01308390358 - N. Mecc. RE 010210
C.F. e P.IVA IT 01308390358



2 About this document

These operating instructions introduce you to the DUET AD device and provide you with information on all the stages required for the installation of the device.

	<p>Warning: Before commissioning, it is essential that the safety instructions in the relevant section are read and understood, and then observed! Non-observance can result in danger to persons or damage to the equipment.</p> <p>► Disconnect the electrical power supply before any operation on the device!</p>
	<p>NOTICE: Read and observe the warnings in this document. Warnings are there to protect you from danger, and to help you to avoid damage to the device.</p>
	<p>NOTICE: Instructions explain the advantages of certain settings and help you use the device to the best possible effect..</p>

3 General Description

3.1 DUET AD

The DUET AD represents EC-motors (brushless DC motor) with an integrated torque, speed, position control electronic and a 14 bit single-turn absolute encoder.

The desired command can be set via analogue signal input 0 ... +10 V. The four operating modes "clockwise rotation", "counter clockwise rotation", "Off" (rapid break- point with freewheel) and "Stop" (rapid breakpoint with holding torque) are controlled via the two digital inputs IN0 and IN1. Optional, two further digital inputs for additional functions are available. Therewith, among other things, 2 fixed motor speeds (e.g. for rapid movement and creep speed), acceleration ramp and braking ramp can be memorized on the device EEPROM. Two digital output signals are available additionally: one giving

12 pulses per turn (e.g. for position and speed control), the other showing "fault".

Additionally, the device can be operated via Modbus RTU or CAN Open (only available on CAN Model)

By means of the integrated absolute single-turn encoder with a resolution 16384 increments per revolution, a very high positioning accuracy with very good regulating characteristics can be achieved.

In case of larger needs, customer specific solutions with special firmware are available on request.

The DUET AD has except of the ball bearings no expendable parts and is hence excellently suited for continuous operation. The motors Device can be combined with planetary or worm gears with a multitude of gear ratios.

3.2 Proper use

The DUET AD is a supplied part and may be installed into (industrial) machinery and equipment in the described configuration.

The device must be securely fixed and may only be installed using cables and components specified by Motor Power Company.

The Device may only be put into operation once the entire system has been installed in accordance with EMC. Please follow the instructions in chapter 7.2.

3.3 Standards and guidelines

EU guidelines: the EU guidelines formulate the minimum requirements made on a product and must be observed by all manufacturers and dealers marketing the product in the member states of the European Union.



Machine guideline: the device is a machine in the sense of the EU guideline for machinery. It has moveable parts in accordance with its intended purpose: however, it may only be installed as a component of a machine or a system. The advice described in these instructions regarding installation and operation must be adhered to.

EMC guideline: the EU guidelines for EMC apply to devices which can cause electromagnetic interruptions or whose operation can be impaired by these interruptions. Compliance of the drive with the EMC guideline

can only be tested once it has been installed. The information pertaining to EMC described in these instructions must be adhered to.

Conformity: by means of the conformity declaration of the product (see appendix), Motor Power Company confirms that the device complies with the safety standards listed therein and with EMC standards. The product may be sold and used within the European Union.

4 Safety instructions

	<p>Warning: Before commissioning, it is essential that the safety instructions in the relevant section are read and understood, and then observed! Non-observance can result in danger to persons or damage to the equipment.</p> <p>► Disconnect the electrical power supply before any operation on the device!</p>
	<p>NOTICE: The drive must only be installed and adjusted by qualified persons in accordance with the relevant standards. Qualified persons are those who:</p> <ul style="list-style-type: none"> ► based on their experience, can recognize and avoid potential dangers. ► are familiar with the accident prevention regulations for the equipment deployed. ► can connect circuits and install equipment in accordance with the standards and regulations.
	<p>NOTICE: To ensure trouble-free operation, appropriate methods of transport and conditions of storage must be deployed.</p> <p>Please store the drive so that it is protected from:</p> <ul style="list-style-type: none"> ► dust, dirt and moisture <p>Take care also at the storage conditions:</p> <ul style="list-style-type: none"> ► e.g. storage temperature! <p>(See technical data) Transport the drive under storage conditions</p> <ul style="list-style-type: none"> ► protection against shock

5 Technical data, accessories

5.1 Electrical data

Speed range adjustable	0 ... 3000 Rpm
Minimum device voltage	15 V DC
Maximum device voltage	50 V DC
Maximum ripple on supply voltage	Max. 5 %
Recommended logic supply	24 V +/- 10%
Undervoltage shutdown Logic	< 16,5 V
Demolition boundary	> 78 V
Required external fuse	25 AT external
Overtemperature protection	> 110°C at the power output stage
Max. peak current (2 sec.)	50 A
Current consumption of 24 V-logic supply	70 mA + power of digital outputs

5.2 Mechanical data

Device Temperature range	-20 °C ... +100 °C housing temperature
Recommended environmental temperature range *)	0 °C ... 40 °C
Storage Temperature	-20 °C ... 50 °C
Relative humidity	Max. 90% (not condensing)
Protection class	IP54 (IP65 with oil seal)
Altitude	1000 m sl. At higher altitude a derating could be applied.

*) The motor is specified for an ambient temperature of 40°C. The performance data refer to this ambient temperature.

***) The protective system only refers to the device casing. The shaft is to be sealed by the client. The drive may only be used in an environment complying with IP54 if the shaft outlet has been installed such that it is protected from dust and water.

5.3 Dimensions

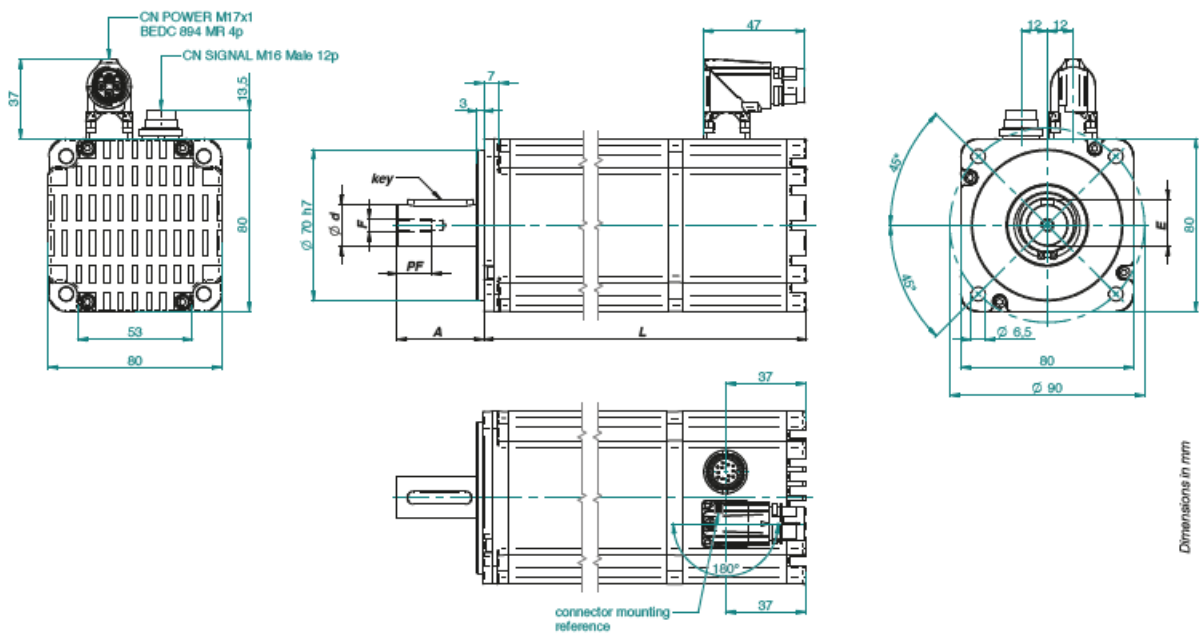

5.4 DUET AD 1,5 03

Motor Power Company s.r.l.

Via Leonardo Da Vinci, 4
 42024 Castelnovo Sotto Reggio Emilia - Italia
 Tel. +39 0522 682710 - Fax +39 0522 683552
 info@motorpowerco.it - motorpowerco.com
 Cap. Soc. 250.000,00€ i.v. - R.E.A. di RE 175521
 Iscr.Reg.Impr. di RE n.01308390358 - N. Mecc. RE 010210
 C.F. e P.IVA IT 01308390358

**MOTOR
 POWER**
 COMPANY

Nominal voltage	48 Vdc	
Nominal power	480 W	
Rated speed	3000 Rpm	
Rated torque	1,53 Nm	
Rated current	11 Arms	
Weight	approx. 2,3 Kg	

5.5 DUET AD 2,8 02

Nominal voltage	48V	
Nominal power	630 W	
Rated speed	3000 rpm	
Rated torque	2 Nm	
Rated current	17,7 Arms	
Weight	approx. 3,1 Kg	

*) Rated output with 250x250x6mm heat sink flange.

5.6 Accessories

Planetary gear:

Available high efficiency planetary gears, with very compact design. Configuration "direct coupling" also available.

Available gear ratio from 3:1 ... 216:1

Brake:

The device can be fitted with a power-off brake option.

6 Protective functions

6.1 Ballast circuit

During braking operations, kinetic energy is stored as electrical energy in an intermediate part of the regulation circuit. This can cause excessive voltage in the intermediate circuit, which, in an extreme case, could cause damage to electrical components. To prevent this, a DC-power supply should be used which has a bridge rectifier and a smoothing capacitor of at least 1000 μF per 1 A nominal motor current.

In addition, an external ballast resistor (drop resistor) is necessary.

Motor Power Company recommends a resistor of 4,7 Ω .

The ballast resistor must be defined depending on the braking power (at least 50watts). It is necessary to use a fuse of 6,3AT against overloading of the ballast resistor.

The ballast circuit switches on at 52V and off at 50V device voltage. It does only work and protect the device (and supply) if the ballast resistor is connected like shown in chapter 8.1 / 8.2.

According to standard, Motor Power Company offers the braking resistor (must be ordered separately).

005016001114 RESISTENZA DI FRENATURA 200W 4,7OHM HSC2004R7J

005016001116 RESISTENZA DI FRENATURA 500W 4,7OHM RS PRO

6.2 Current limitation

To protect the motor against overloading, the motor current (phase current) will be supervised from a I2t protective function and will be limited (if necessary).

7 Installation

	<p>Warning: Before commissioning, it is essential that the safety instructions in the relevant section are read and understood, and then observed! Non-observance can result in danger to persons or damage to the equipment.</p> <p>► Disconnect the electrical power supply before any operation on the device!</p>
---	---

8 Mechanical assembly

	<p>Warning: During installation, ensure that connectors are not damaged. Bent pins can cause a short circuit and destroy the device.</p>
--	---

Check the drive for visible damage before carrying out the installation. Do NOT install damaged devices.

The device must be fastened to a flat surface using 4 screw connections. The flange screws must be prevented from distortion by means of spring washers.

The motor shaft axial and radial loads are:

- Radial load: 350N (applied on the shaft center)
- Axial load: 110N (applied on the shaft center)

8.1 EMI compatibility

Electromagnetic radiated interferences occur in the DUET AD and the machine in which the drive is installed. Should no suitable protective measures be implemented, these interferences can influence the signals of control panel wirings and can endanger the system operational safety.

For complying with limits in accordance with DIN EN 61000-6-4 (emission standard for industrial environments), it is necessary to use shielded connection cables as well as low-inductive shield connection for all components.

Further measures can be necessary depending on the application.

For complying with limits in accordance with DIN EN 61000-6-3 (emission standard for residential environments), further measures are required.

These measures can be:

- Assembling the device in metal housing, or metallizing plastic housing
- Low-inductive connection of all components in the system
- Hidden shielded cable routing in metal ducts
- Using additional suppression components (ferrite or filter modules).
- Additional storage capacitors

The electromagnetic compatibility of the machine must be tested and ensured before it is put into operation.

8.2 Ground wire

- The motor housing must be connected to the machine earth via a separate earth wire.
- Please do not touch the connector pins.

**NOTICE:**

To protect the drive against damage or destruction by static discharge (ESD), the motor housing must be earthed.

Motor Power Company s.r.l.

Via Leonardo Da Vinci, 4
42024 Castelnuovo Sotto Reggio Emilia - Italia
Tel. +39 0522 682710 - Fax +39 0522 683552
info@motorpowerco.it - motorpowerco.com
Cap. Soc. 250.000,00€ i.v. - R.E.A. di RE 175521
Iscr.Reg.Impr. di RE n.01308390358 - N. Mecc. RE 010210
C.F. e P.IVA IT 01308390358

**MOTOR
POWER**
COMPANY

8.3 Motor power supply

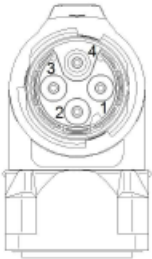

N° PIN	CN M17 90° 4p Male Power Connection
1	U power
2	Ballast
3	GND
4	Protective Ground PE

Ref drawing EDADC

*1) Lead colors refers to standard connection cables of Motor Power Company.

*2) By default, Pin 4 is connected to the motor housing via the motor connector housing. Therefore, it is not suited as protective earth but only as functional earth.



NOTICE:

Not turning the connector of more than 180°!

Consequence:

Short circuit, short circuit to frame or malfunction by unfixed wires at the solder point possible

Motor Power Company s.r.l.

Via Leonardo Da Vinci, 4
42024 Castelnovo Sotto Reggio Emilia - Italia
Tel. +39 0522 682710 - Fax +39 0522 683552
info@motorpowerco.it - motorpowerco.com
Cap. Soc. 250.000,00€ i.v. - R.E.A. di RE 175521
Iscr.Reg.Impr. di RE n.01308390358 - N. Mecc. RE 010210
C.F. e P.IVA IT 01308390358

**MOTOR
POWER**
COMPANY

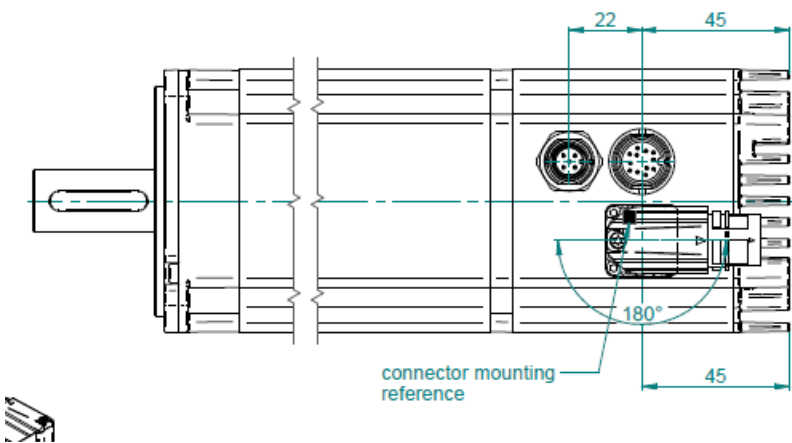

Ref. drawing Q0BH27

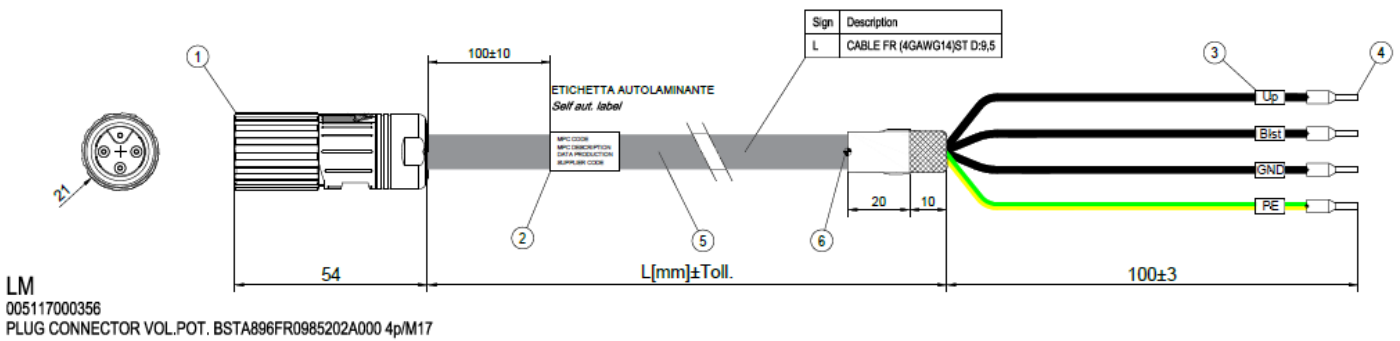

LM
005117000356
PLUG CONNECTOR VOL.POT. BSTA896FR0985202A000 4p/M17

Ref drawing N13H12

Mating connector with cable (please order in addition)

For DUET AD with 4-pin connector, pre-assembled connection cables are available in a range of lengths from stock. On one end these cables have the appropriate 4-pin right-angle connector already fitted.

The following cable lengths are available

Cable length 5000mm MPC code 003108020546

Motor Power Company s.r.l.
Via Leonardo Da Vinci, 4
42024 Castelnovo Sotto Reggio Emilia - Italia
Tel. +39 0522 682710 - Fax +39 0522 683552
info@motorpowerco.it - motorpowerco.com
Cap. Soc. 250.000,00€ i.v. - R.E.A. di RE 175521
Iscr.Reg.Impr. di RE n.01308390358 - N. Mecc. RE 010210
C.F. e P.IVA IT 01308390358



Mating connector is available:

005117000356 CONNETTORE VOL.POT. BSTA896FR0985202A000 4p/M17

8.4 Signal interface supply

Plug:

Round plug to DIN 45326, Binder, Series 723

The 12pin motor connector is for logic supply of the motor.

Ref drawing EDADC

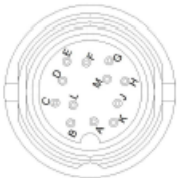

N°PIN	CN 091 12p Male. <i>DIGITAL I/O Connection</i>
A	IN0
B	IN1
C	IN2
D	IN3
E	OUT1
F	OUT2
G	AI+
H	AI-
J	Uc (24V)
K	GND (0V)
L	Service-
M	Service+

Inserire disegno cavo segnale, ref. Drawing N13H13

Motor Power Company s.r.l.

Via Leonardo Da Vinci, 4
42024 Castelnovo Sotto Reggio Emilia - Italia
Tel. +39 0522 682710 - Fax +39 0522 683552
info@motorpowerco.it - motorpowerco.com
Cap. Soc. 250.000,00€ i.v. - R.E.A. di RE 175521
Iscr.Reg.Impr. di RE n.01308390358 - N. Mecc. RE 010210
C.F. e P.IVA IT 01308390358

**MOTOR
POWER**
COMPANY

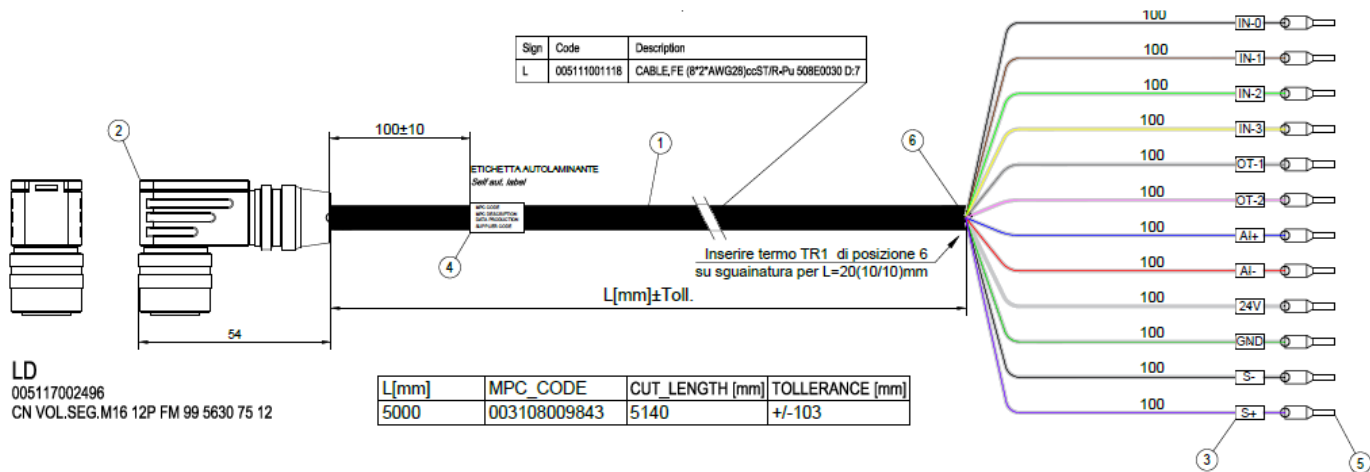

*) Lead colors refer to standard connection cables of Motor Power Company.

The following cable lengths are available

Cable length 5000mm MPC code 003108009843

Mating connector is available:

005117002496 CN VOL.SEG.M16 12P FM 99 5630 75 12

8.5 Schematic circuit of the digital inputs

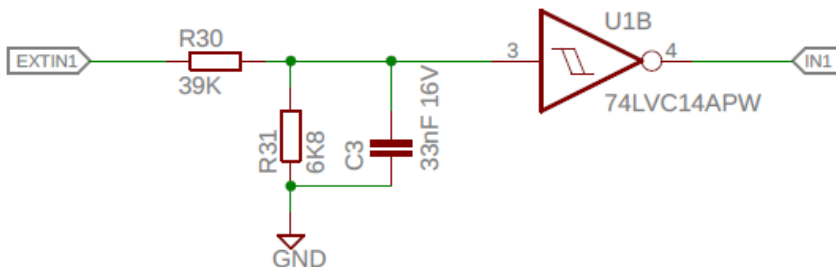

Da rifare disegno

Motor Power Company s.r.l.
 Via Leonardo Da Vinci, 4
 42024 Castelnovo Sotto Reggio Emilia - Italia
 Tel. +39 0522 682710 - Fax +39 0522 683552
 info@motorpowerco.it - motorpowerco.com
 Cap. Soc. 250.000,00€ i.v. - R.E.A. di RE 175521
 Iscr.Reg.Impr. di RE n.01308390358 - N. Mecc. RE 010210
 C.F. e P.IVA IT 01308390358



8.6 Schematic circuit of the digital outputs

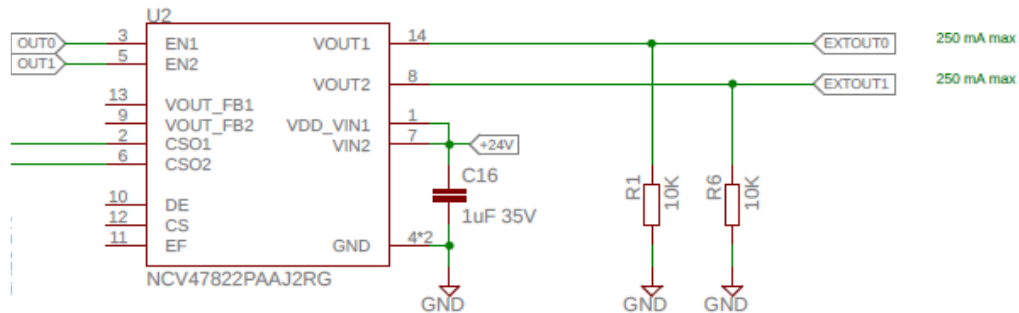

Da rifare disegno

Mating connector with cable (please order in addition) For DUET AD with 12-pin connector, pre-assembled connection cables are available in a range of lengths from stock. On one end these cables have the appropriate 12-pin right-angle connector already fitted. At the other end the cable is simply cut off.



NOTICE:

Not turning the connector of more than $+45^\circ / - 45^\circ$.

Consequence:

Short circuit, short circuit to frame or malfunction by unfixed wires at the solder point possible.

Motor Power Company s.r.l.

Via Leonardo Da Vinci, 4
42024 Castelnovo Sotto Reggio Emilia - Italia
Tel. +39 0522 682710 - Fax +39 0522 683552
info@motorpowerco.it - motorpowerco.com
Cap. Soc. 250.000,00€ i.v. - R.E.A. di RE 175521
Iscr.Reg.Impr. di RE n.01308390358 - N. Mecc. RE 010210
C.F. e P.IVA IT 01308390358

**MOTOR
POWER**
COMPANY



8.7 Maximum cable length and power supply

TO be defined

*) Can be ordered at Motor Power Company

If the supply of power and logic electronic is processed by separate power sources, the following cable lengths are available:

9 Connection schematic

	<p>Warning: Before commissioning, it is essential that the safety instructions in the relevant section are read and understood, and then observed! Non-observance can result in danger to persons or damage to the equipment.</p> <p>Disconnect the electrical power supply before any operation on the device.</p>
	<p>CAUTION: Incorrect connection of motor power electronics. The motor is not equipped with reverse polarity protection. Consequence: Destroying of the power electronics possible.</p>

	Check the right polarity.
	<p>NOTICE: Loops must be avoided for all grounding concepts. Shielded cable must be used for the whole cable system without interruption. Up to a length of 10m a common power and signal cable can be used. If the cable is longer than 10m it is recommended to separate power and signal in different shielded cables. When standard wires from Motor Power Company are used, the shielding must be spaciouly applied inside the control cabinet.</p>

Failure to follow them can result in danger to persons or damage to the equipment.

9.1 Schematic circuit for power supply controller

	<p>CAUTION: Peak current by switching-on of a variety of series-connected motors.</p> <p>Consequence: Destroying of the integrated electronics possible.</p> <p style="text-align: center;">▶ Using a soft start resistor or adequate power supply.</p>
---	--

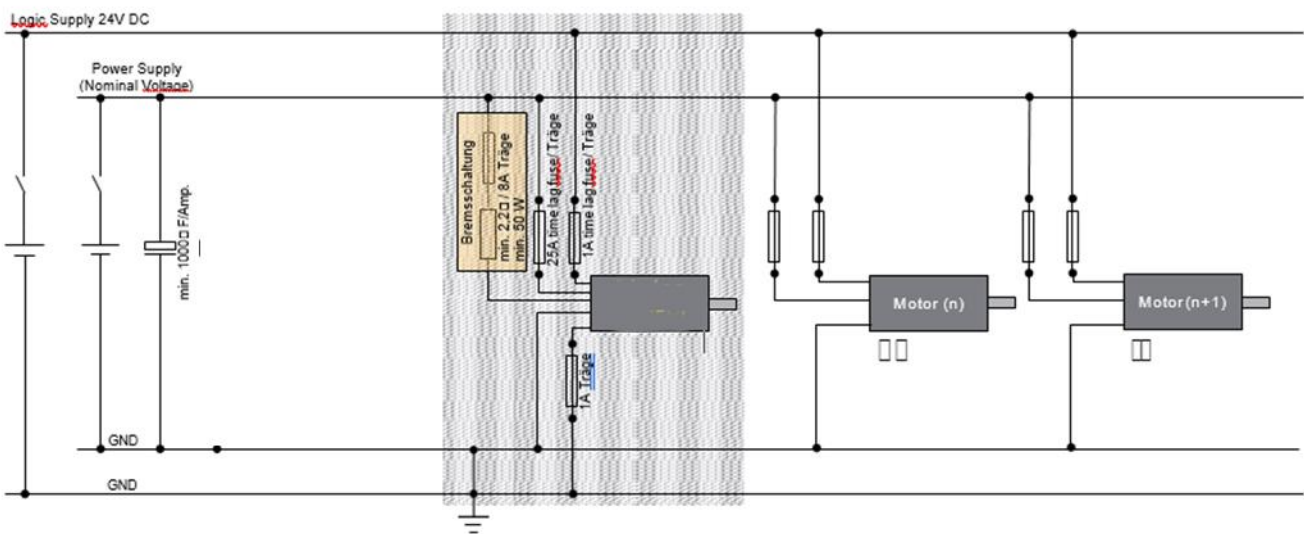

The grey section of the schematic circuit shows the precisely connection of DUET AD. It is also possible to connect in series more devices as shown.

- 1) The non-grey section of the schematic circuit shows only emblematical the connection of several motors.

9.2 Connection motor power supply

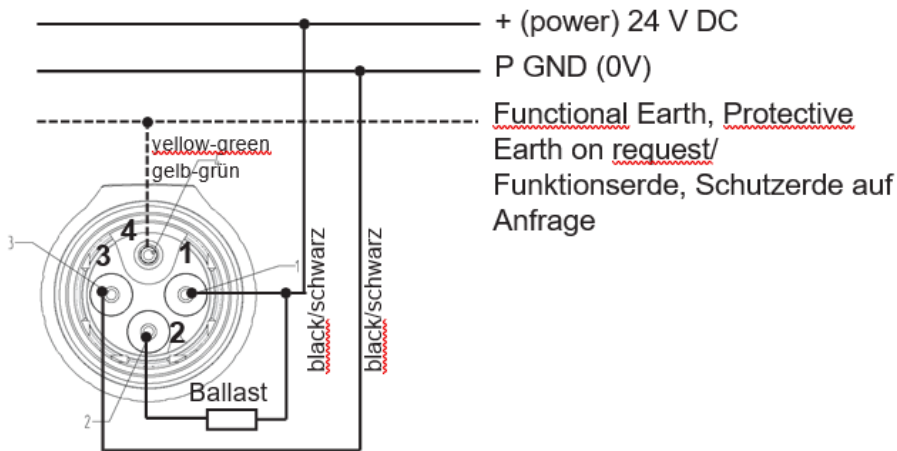

9.3 Connection signal interface supply

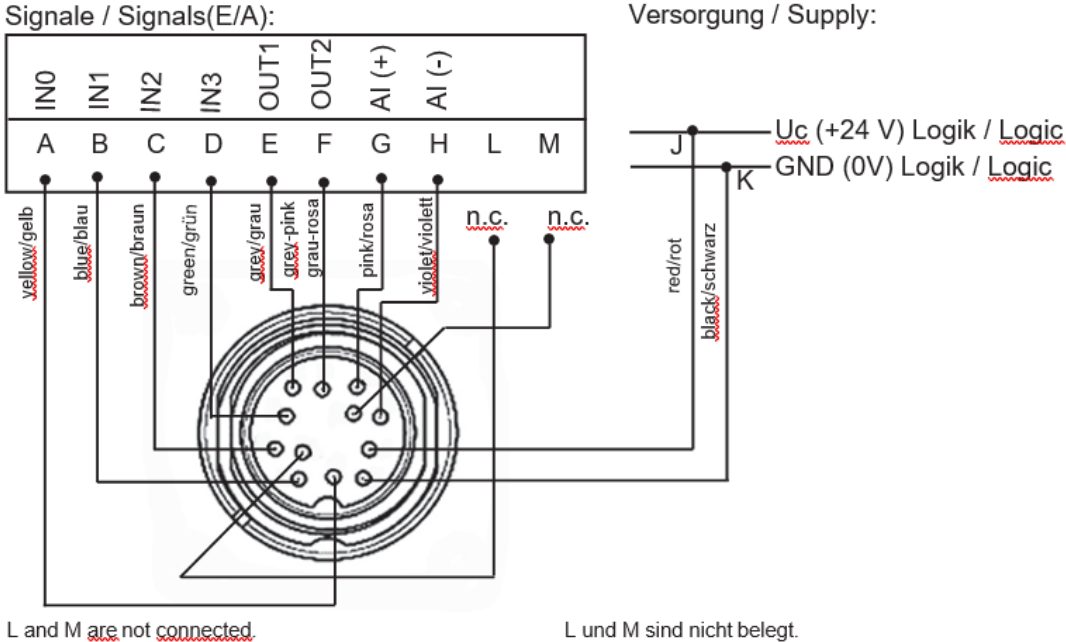

9.4 Can Open connection Interface

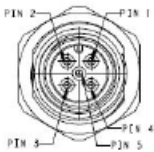

N° PIN	CN M12 5p Male Type A CAN-OPEN Option
1	n.c.
2	n.c.
3	CAN-GND
4	CAN-HIGH
5	CAN-LOW

Ref drawing EDADC

Note: this connector is available only on DUET AD Can Open version

Mating connector is available:

Motor Power Company s.r.l.
 Via Leonardo Da Vinci, 4
 42024 Castelnovo Sotto Reggio Emilia - Italia
 Tel. +39 0522 682710 - Fax +39 0522 683552
 info@motorpowerco.it - motorpowerco.com
 Cap. Soc. 250.000,00€ i.v. - R.E.A. di RE 175521
 Iscr.Reg.Impr. di RE n.01308390358 - N. Mecc. RE 010210
 C.F. e P.IVA IT 01308390358



005117000580 CN VOL. M12 5P. FM IN PLASTICA 8A5000-325

10 Maintenance & Service

10.1 Maintenance, taking out of service and disposal

Maintenance:

This drive does not require maintenance. In the event of a fault, please contact us and only have the device repaired Motor Power Company.

Taking Out of Service:

	<p>NOTICE:</p> <p>The safety instructions must be read and observed prior to taking the unit out of service.</p>
--	--

Disposal:

Take the drive out of service (see above). Dismantle the drive ready for disposal and break it up into its individual components. Sort the individual parts according to material and forward for disposal. Adherence to the requirements of legislation governing disposal and environmental guidelines in the country of use must be ensured when disposing of electronic components and gear lubricant.



Motor Power Company s.r.l.

Via Leonardo Da Vinci, 4
42024 Castelnovo Sotto Reggio Emilia - Italia
Tel. +39 0522 682710 - Fax +39 0522 683552
info@motorpowerco.it - motorpowerco.com
Cap. Soc. 250.000,00€ i.v. - R.E.A. di RE 175521
Iscr.Reg.Impr. di RE n.01308390358 - N. Mecc. RE 010210
C.F. e P.IVA IT 01308390358

**MOTOR
POWER**
COMPANY

10.2 Service & Support

Should you have any questions or problems, please contact:

- Our local distributor
- Our Location Worldwide

You can also visit our online support at:

<http://www.motorpowergroup.com>