

Installation Guidelines

Design Guidelines

To fully optimize the performance of the harmonic reducer, please consider the following points:

- 1.Ensure concentricity for the input shaft, flexspline, output shaft, and housing.
- 2.The wave generator generates axial forces, design the input shaft to withstand these forces.
- 3.As harmonic reducers are compact devices and with significant transmitting torque, use an appropriate tightening torque for the bolts to connect the flexspline and the output shaft.
- 4.Flexsplines undergo elastic deformation, so design the dimensions of the inner wall of the housing according to recommended sizes.
- 5.Match the input and output shafts with suitable bearings (allowing for 2-point support with clearance) capable of supporting radial and axial loads. Avoid applying unnecessary force to the wave generator and flexspline.
- 6.Ensure that the flange diameter for flexspline installation does not exceed the hub hole diameter, and round the corners on the flange connected to the membrane. Design all dimensions according to recommended sizes.
- 7.When using a C-type snap ring to secure the wave generator hub, ensure that the hook portion of the snap ring does not come into contact with the housing.

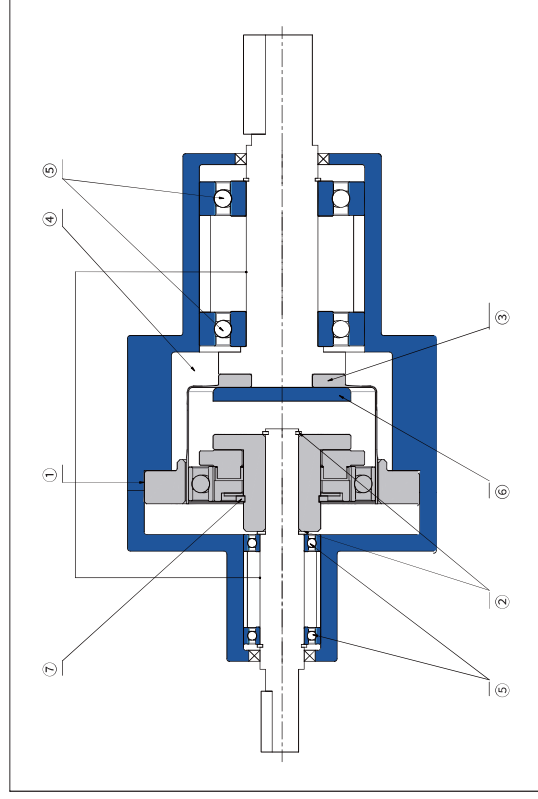

Sealing Mechanism

To prevent lubricating grease leakage and maintain the high durability of the harmonic reducer, the following sealing mechanisms must be utilized.

- 1.Rotary motion components: oil seal (spring-inserted), please pay attention to the presence of scratches on the shaft side.
- 2.Flange assembly surfaces, interlocking: O-ring, sealant. please ensure that the surfaces are not skewed, and check the engagement condition of the O-ring. (Refer to the table diagram below for the dimensions of the installed seal O-ring and O-ring groove during reducer assembly.)
- 3.Screw holes: use sealing screws or adhesive lockers with sealing effects (Leitai 243 is recommended) or sealing tape.

Sealing locations		Recommended sealing methods
Output side	Output flange central through-hole and assembly surface	Use O-ring (Refer to our company's product for installation)
	Mounting screws	Apply a sealing screw-locking agent with sealing effects (Leitai 243 is recommended)
Input side	Flange assembly surface	Use O-ring (Refer to our company's product for installation)
	Motor output shaft	If there is no oil seal, install the oil seal on the installation flange of the motor

Sealing O-ring and O-ring Groove Installation Dimensions Table

Model No.	Flexspline side				Circular Spline side			
	O-ring	O-ring groove			O-ring	O-ring groove		
		∅D1	∅D2	L1		∅D3	∅D4	L2
WSHG-14-II	52x1.5	53.3	56.5	0.89	-	-	-	-
WSHG-17-II	63x1.5	64.1	68.1	1.1	-	-	-	-
WSHG-20-II	72x2	72.6	78	1.5	53x1	54	56.8	0.75
WSHG-25-II	90x1.8	90	94.8	1.35	66x1.3	67	70.5	0.88
WSHG-32-II	116.2x1.9	117.6	123	1.5	87x1.5	88	92	1.13

Sealing O-ring and O-ring Groove Installation Dimension Diagram

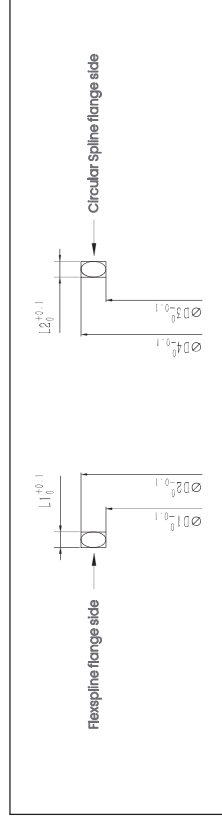

Assembly Precautions

Due to assembly errors, the harmonic reducer may experience vibrations and abnormal noises during operation. Please adhere to the following precautions during assembly:

1. Precautions for the Wave Generator
 - (1) Avoid applying excessive force to the bearing area of the wave generator during assembly. Insert it smoothly by allowing the wave generator to rotate freely.
 - (2) When using an integrated wave generator, pay special attention to keeping the effects of center offset and misalignment within recommended values.
2. Precautions for the Flexspline
 - (1) Confirm the flatness of the installation surface and check for misalignment.
 - (2) Ensure there are no protrusions, residual burrs, or foreign objects in the screw holes.
 - (3) Confirm whether chamfering and avoidance processing have been applied to the housing assembly to prevent interference with the flexspline.
 - (4) After assembling the flexspline to the housing, verify its ability to rotate without interference or jamming at specific locations.
 - (5) When inserting bolts into the screw holes for installation, ensure the correct position of the bolt holes to prevent contact between the bolts and the flexspline due to skewed processing.
 - (6) Do not tighten the bolts to the specified torque all at once. Initially, temporarily tighten them with approximately half the specified torque, then tighten to the specified torque. Additionally, typically tighten the bolts in a diagonal sequence.
 - (7) Avoid using a punch on the flexspline as it may result in reduced rotational accuracy; hence, minimize its use.
3. Precautions for the Circular Spline
 - (1) Confirm the flatness of the installation surface and check for misalignment.
 - (2) Ensure there are no protrusions, residual burrs, or foreign objects in the screw holes.
 - (3) Confirm whether chamfering and avoidance processing have been applied to the housing assembly to prevent interference with the circular spline.
 - (4) When inserting bolts into the screw holes for installation, ensure the correct position of the bolt holes to prevent contact between the bolts and the circular spline due to skewed processing.
 - (5) Similar to the flexspline, do not tighten the bolts to the specified torque all at once. Initially, temporarily tighten them with approximately half the specified torque, then tighten to the specified torque. Additionally, typically tighten the bolts in a diagonal sequence.
 - (6) Confirm the presence of extreme one-sided meshing when combined with the flexspline. Extreme offset may occur due to center offset or misalignment of the two components.
 - (7) Avoid striking the gear front end or applying excessive force when pressing during the assembly of the circular spline.
4. Others:
 - (1) Install the harmonic reducer in a sufficiently clean environment, ensuring no foreign objects enter the reducer during the installation process to prevent damage during use.
 - (2) Ensure that the gear surfaces and flexible bearing parts of the reducer remain adequately lubricated. It is not recommended to have the gear surface always facing upwards, as it may affect lubrication effectiveness.
 - (3) After installing the wave generator, confirm that the engagement between the flexspline and the circular spline is 180° symmetric (Figure 1). Any deviation (Figure 2) may cause abnormal vibrations and quickly damage the flexspline.
 - (4) After installation, run the reducer at low speed (100 rpm) first. If there is abnormal vibration or noise, stop immediately, recheck the installation, and contact our company to prevent damage to the reducer due to incorrect installation.

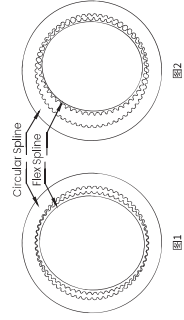

Assembly Method

1. WCSG Installation (circular spline fixed, flex spline output)

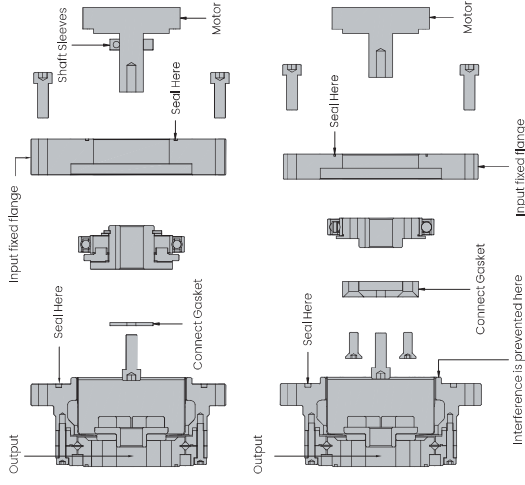

1. Apply the grease evenly on the flexible bearing, and fill the cavity connected with the fixed flange and the motor with the grease (please use the specified grease, do not replace the grease randomly to avoid damage to the reducer). Install the wave generator on the motor shaft or connecting shaft of the input end, and fix it with screw and flat gasket or connecting end cover.
2. Apply the grease evenly on the flexible spline, and fill flex spline with the grease. The injection volume is approximately 80% of the cavity volume (please use the specified grease, do not replace the grease randomly to avoid damage to the reducer). Install the reducer according to the diagram. When installing, the long axis of the wave generator is aligned to the direction of the long axis of the reducer's flex spline. When in place, the reducer is fixed with the corresponding screw. The pre-tightening force of the screw is 0.5Nm.
3. Set the motor speed at about 100 rotations per minute, start the motor, and the screws shall be locked by means of a crossbar for four to five times to increase the locking force of the screws equally. (for screw locking force, see page 96) all fixed screws shall be of grade 12.9 and shall be coated with Loctite 243 thread adhesive to prevent screw failure or loose during operation.
4. Processing requirement for mounting surface that connected with reducer: flatness 0.01mm, vertical axis 0.01mm.

Note:

When the reducer is in use, if the output end is always horizontally facing down, (it is not recommended to use in this way), please contact us if the lubricating oil injected into the inner wall of the flex spline exceeds the meshing tooth surface. Please use the specified lubricating grease, do not change the grease at will to avoid damage to the reducer. Static sealing shall be adapted between the circular spline of the reducer and the installation plane of input end to ensure the grease will not leak during the use of reducer and avoid the damage of reducer when it works with little or no oil.

2.WSHG-1/II installation (1) (Circular spline fixed, flex spline output)

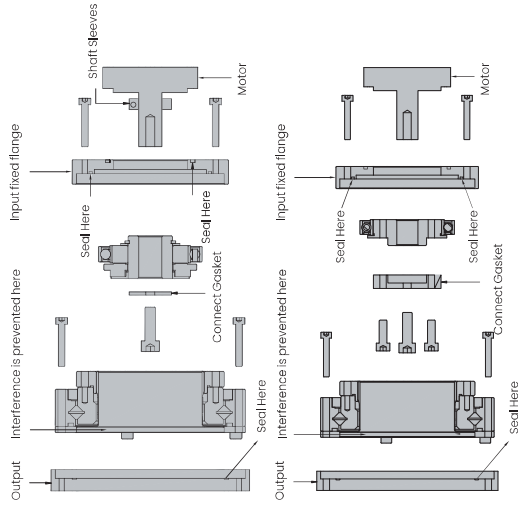

1. Apply the grease evenly on the flexible bearing, and fill the cavity connected with the fixed flange and the motor with the grease (please use the specified grease, do not replace the grease randomly to avoid damage to the reducer). Install the wave generator on the motor shaft or connecting shaft of the input end, and fix it with screw and flat gasket or connecting end cover.

2. Install the reducer according to the diagram. When installing, the long axis of the wave generator is aligned to the direction of the long axis of the reducer's flex spline. When in place, the reducer is fixed with the corresponding screw. The pre-tightening force of the screw is 0.5Nm.

3. Set the motor speed at about 100 rotations per minute, start the motor, and the screws shall be locked by means of crisscross for four to five times to increase the locking force of the screws equally. (for screw locking force, see page 96) all fixed screws shall be of grade 12.9 and shall be coated with Loctite 243 thread adhesive to prevent screw failure or loose during operation.

4. Apply a layer of grease evenly on the inner wall of the flexible pulley, and then inject the grease into the cavity of the flexible pulley. The injection amount is about 80% of the cavity of the flexible pulley.

5. The output end is also fixed according to step 3. All fixed screws shall be grade 12.9 and coated with Loctite 243 thread adhesive to prevent screw failure or loose during operation.

6. Machining requirements for installation plane fixed with reducer: plane degree 0.01mm, and axis perpendicular 0.01mm

Note:

When the reducer is in use, if the output end is always horizontally facing down (it is not recommended to use in this way), please contact us if the lubricating oil injected into the inner wall of the flex spline exceeds the meshing tooth surface. Please use the specified lubricating grease, do not change the grease at will to avoid damage to the reducer. Static sealing shall be adapted between the circular spline of reducer and the installation plane of input end to ensure the grease will not leak during the use of reducer and avoid the damage of reducer when it works with little or no oil.

3.WSHG-1/II installation (2) (Flex spline fixed, circular spline output)

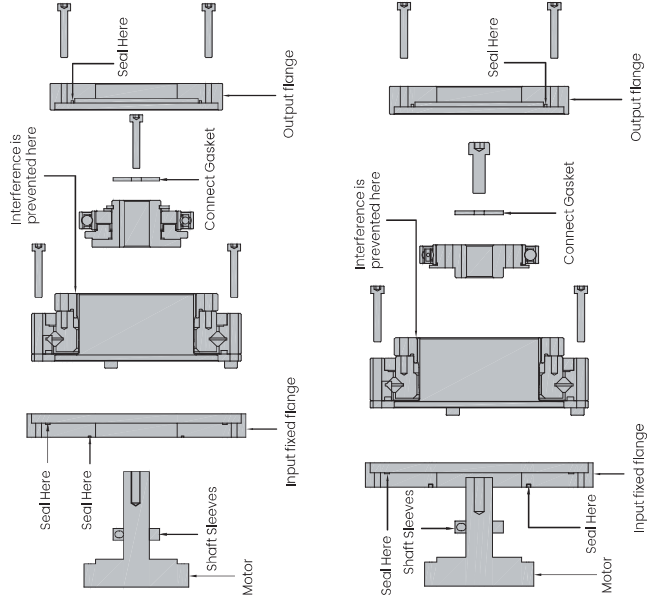

1. The reducer is installed at the input end and fixed with the corresponding screw. The screw pretightening force is 0.5Nm.
2. First, evenly apply a layer of grease on the inner wall of the flex spline, and then inject grease at the space B of the flex spline with an injection amount of about 80% of the cavity of the flex spline (please use the specified lubricating grease, and do not replace the grease at will to avoid damage to the reducer).
3. Install the reducer according to the diagram. When installing, the wave generator long axis aligned with the long axis of the flex spline, after installing in place, turn the wave generator, make the key on the CAM and the key on the input shaft alignment, install the key (key coated with Loctite 638 glue), with a screw plus large gasket to fix the wave generator on the shaft.
4. Apply grease uniformly on the flexible bearing and fill the cavity of A with grease (please use the specified lubricating grease and do not change grease at will to avoid damage to the reducer)
5. Set the motor speed at about 100 RPM, start the motor, and tighten the screws crossingly for four to five times with equal increase to the locking force corresponding to the screw. (The locking force for screws is shown on page 96.) All screws to be fastened shall be of grade 12.9 and coated with Loctite 243 thread adhesive to prevent failure or loose working
6. The output end is also fixed according to step 5. All fixing screws shall be of grade 12.9 and coated with Loctite 243 thread adhesive to prevent screw failure or loosening during operation.
7. Machining requirements for installation plane fixed with reducer: plane degree 0.01mm, and axis perpendicular 0.01mm.

Note:

When the reducer is in use, if the output end is always horizontally facing down (it is not recommended to use in this way), please contact us if the lubricating oil injected into the inner wall of the flex spline exceeds the meshing tooth surface. Please use the specified lubricating grease, do not change the grease at will to avoid damage to the reducer. Static sealing shall be adapted between the circular spline of reducer and the installation plane of input end to ensure the grease will not leak during the use of reducer and avoid the damage of reducer when it works with little or no oil.

4. WSHG-III Installation (3) (4) (Flex spline fixed, circular spline output)

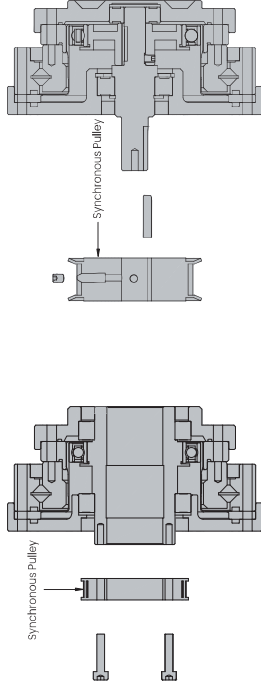

5. The reducer mount way when the motor shaft is smooth shaft

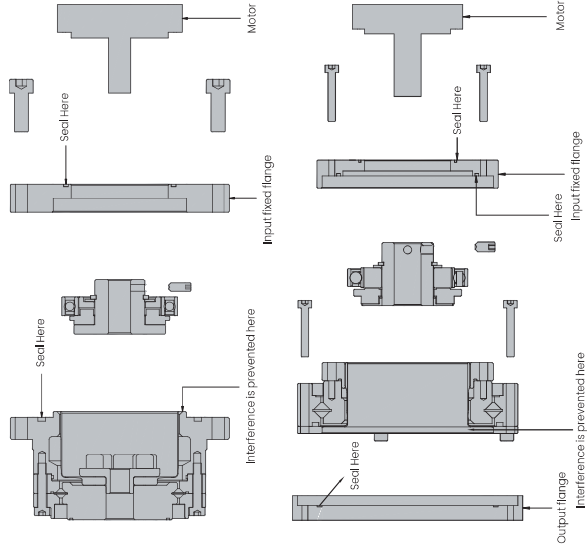

6. Screw locking method

1. Set motor speed at 100 rpm, and start motor. The screws are locked in crisscross manner. Try 4 to 5 times increased by degrees until it reaches corresponding locking force (see chart below).
2. Mounting plane processing requirements prescribed by connecting reducer: flatness 0.01mm, Screw locking method.

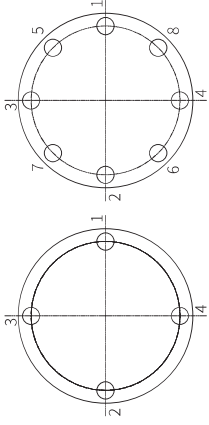

Screws correspond to locking force

		12.9							
Screw Nominal Diameter	mm	3	4	5	6	8	10	12	
Locking Torque	N · m	2	4	9	15	35	70	125	

Installation accuracy of reducer

Motor installation

Flange for motor installation: when the motor is installed on the combined type, the motor installation flange must be used for installation. The civil construction size and schedule of the flange base components for motor installation are shown in the following figure and table.

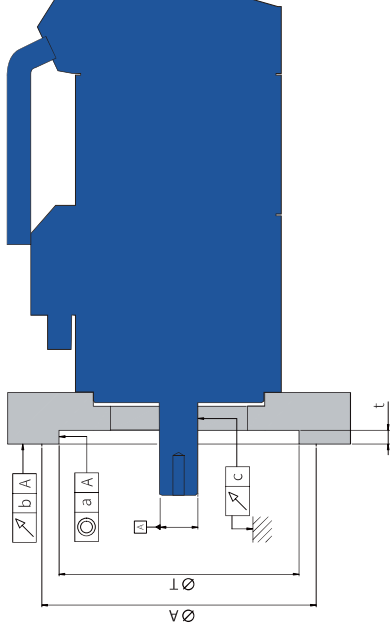

Unit:mm

Model Symbol	14	17	20	25	32
a	0.03	0.04	0.04	0.04	0.04
b	0.03	0.04	0.04	0.04	0.04
c	0.015	0.015	0.018	0.018	0.018
ØA	73	79	93	107	138
t	3	3	4.5	4.5	4.5
ØT	38H7	48H7	56H7	67H7	90H7

WCSG - II Series assembly precision

Flange for motor installation: when installing the motor to the combined type, the motor mounting flange must be used for installation. Please refer to the following table and figure for mounting dimensions and precision of flange base components for motor installation.

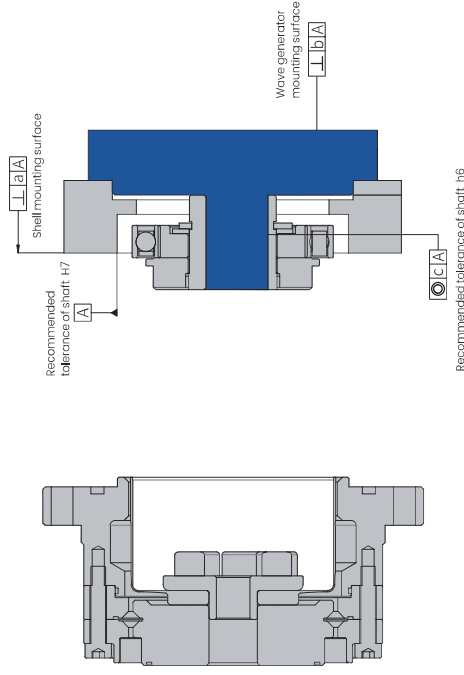

Model Symbol	14	17	20	25	32
a	0.011	0.015	0.017	0.024	0.026
b	0.017 (0.008)	0.020 (0.010)	0.020 (0.010)	0.024 (0.012)	0.024 (0.012)
c	0.030 (0.016)	0.034 (0.018)	0.044 (0.019)	0.047 (0.022)	0.050 (0.022)

Unit:mm

The values in () are those when the input unit (wave generator) is integrated structure.
(When European coupling structure is not used)

WCSD- I Series assembly precision

During assembly design, if there are abnormalities such as deformation of the mounting surface, or reluctant assembly, the product performance will be reduced. In order to give full play to the excellent performance of reducer, please pay attention to the following points and ensure to use the recommended precision of the assembled casing shown in the following picture and table.

- 1.The mounting surface is skewed and deformed
- 2.Foreign matter engaged-in
- 3.Burrs, bulges, and abnormal positions around the screw holes of the mounting holes
- 4.Insufficient chamfering of mounting concave round part
- 5.The roundness of the mounting concave round part is abnormal

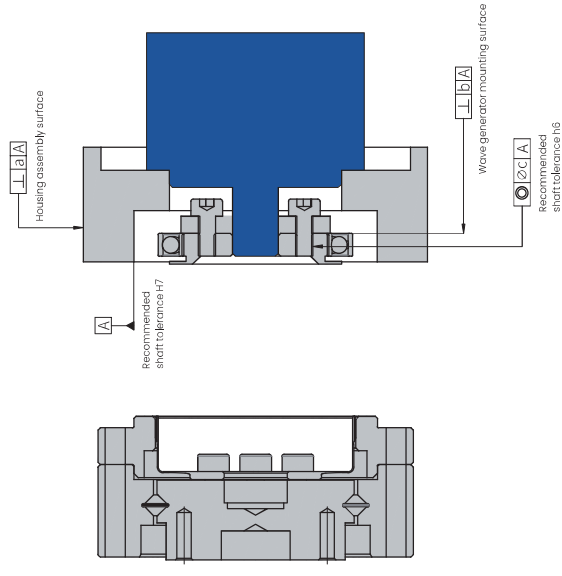

Model Symbol	14	17	20	25	32
a	0.011	0.015	0.017	0.024	0.026
b	0.008	0.010	0.012	0.012	0.012
∅c	0.016	0.018	0.019	0.022	0.022

Unit:mm

WSHG-II series assembly precision

During assembly design, to insure that harmonic reducer in use with optimal performance, please insure that using the recommend precision of assemble housing as shown below. (see chart below).

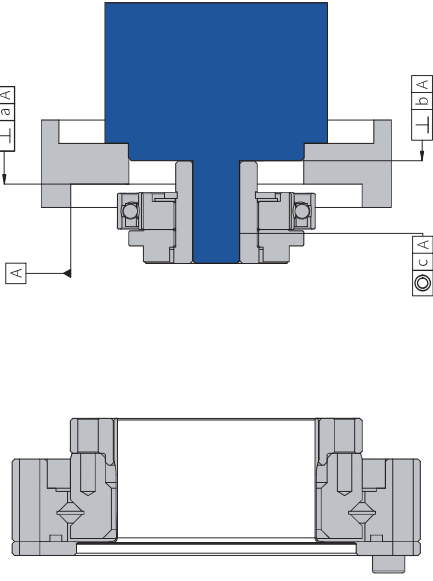

Unit:mm

Model Symbol	14	17	20	25	32
a	0.011	0.015	0.017	0.024	0.026
b	0.017	0.020	0.020	0.024	0.024
	(0.008)	(0.010)	(0.010)	(0.012)	(0.012)
c	0.030	0.034	0.044	0.047	0.050
	(0.016)	(0.018)	(0.019)	(0.022)	(0.022)

Value in () is the numerical values when input unit(wave generator) is one-piece structure (unused European coupling structure)

WSHD-I (II) series assembly precision

During assembly design, product performance will be reduced if there is abnormal situation, such as deformation of mounting surface. Assembled reluctantly will decrease product performance as well.

To insure that harmonic reducer in use with optimal performance, please pay attention to the following points, and insure that using the recommend precision of assemble housing as shown below. (see chart below).

- 1.Deflection and distortion about assembled surface
- 2.Foreign body embedding
- 3.Screw hole of mounting hole appears burr around, bulge, and abnormal position
- 4.The chamfering concave part is insufficient
- 5.The roundness of installation concave part is abnormal

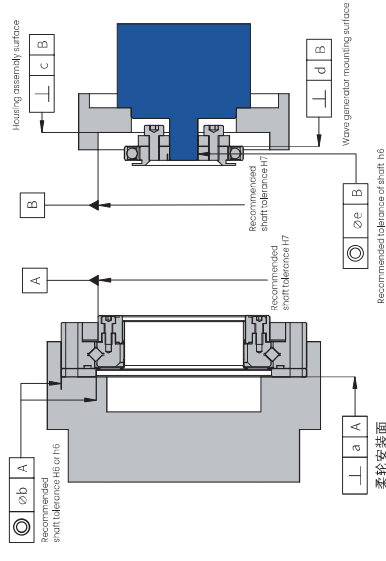

Unit:mm

Model Symbol	14	17	20	25	32
a	0.016	0.021	0.027	0.035	0.042
øb	0.015	0.018	0.019	0.022	0.022
c	0.011	0.012	0.013	0.014	0.016
d	0.008	0.010	0.012	0.012	0.012
øe	0.016	0.018	0.019	0.022	0.022

Application area



Robots



Armarium



Communication equipment



Machine tool



Detection and analysis equipment



Printing equipment



Aerospace area



Semiconductor processing equipment

Lubricating Grease Usage

Harmonic Reducer Lubrication Requirements

- (1) Harmonic reducers undergo frequent start-stop and reciprocating movements, leading to wear and a decrease in precision. Therefore, the lubricating grease must possess excellent extreme pressure and anti-wear properties.
- (2) Robot joint structures are compact, have poor heat dissipation, and can experience elevated temperatures during prolonged continuous operation. The lubricating grease is required to exhibit good thermal stability and oxidation resistance.
- (3) Harmonic reducers frequently start and undergo reciprocating movements in confined spaces, enduring high-speed and high-load operations. Consequently, the grease must provide long-life lubrication, resist carbon buildup, remain color-stable, and avoid oil separation.
- (4) Due to friction, vibration, and collisions in the transmission gears of harmonic reducers, intense noise is generated. Lubricating grease is expected to have a strong oil film thickness and adhesion to effectively reduce noise.

In summary, the selected lubricating grease should possess excellent thermal stability, extreme pressure resistance, good noise reduction properties, and an exceptionally long service life.

Harmonic Reducer Lubricating Grease Requirements

Our company currently uses a customized lubricating grease with the following characteristics:

- *Contains organic molybdenum, effectively preventing localized high-temperature sintering under high-load operation.
- *With special oil additives, it can effectively suppress wear in harmonic transmission, avoiding abnormal heating in confined spaces.
- *Exhibits strong adhesion to sliding surfaces. With the assistance of special additives, it maintains an effective oil film on unlubricated surfaces, preventing wear and heat generation even during high-speed rotation.
- *Broad operating temperature range: -40°C to 150°C.

Performance Parameters of Lubricating Grease

Experiment items	Experimental Conditions	Representative Parameters
Appearance	Visual inspection	Yellow
Thickening agent	/	Special lithium-based
Base oil	/	Highly refined mineral oil
Mixed needle penetration	25°C	280
Drop point°C	/	197
Copper corrosion	00°C,24h	Qualified
Separation stability mass%	100°C,24h	1.52
Evaporation loss mass%	99°C,22h	2.0
Low torque mN.m -40°C	Start operate	198 63

Harmonic Reducer Lubricating Grease Requirements

- (1) For cup-type and cap-type hollow combination reducers, the internal concealed parts are pre-filled with lubricating grease before leaving the factory. However, when assembling the wave generator, it is necessary to inject and apply lubricating grease.
- (2) The input and output ends of the harmonic reducer must have a strictly sealed structure. For dynamic sealing locations, it is recommended to use skeleton oil seals for sealing. For static sealing locations, O-rings or sealing adhesives are recommended, and it must be ensured that the sealing surface is neither skewed nor damaged.
- (3) Use the recommended semi-fluid lubricating grease specifically designed for harmonic reducers and avoid mixing with other lubricating greases.
- (4) The method of using lubricating grease must follow the instructions. Please note that different models may require different amounts of lubricating grease for injection and application.
- (5) During the use of the harmonic reducer, if the wave generator remains consistently upward, it may lead to poor lubrication. In this case, increase the amount of lubricating grease injection or consult our company.
- (6) The performance of lubricating grease will change with temperature, and degradation occurs faster at higher temperatures. To ensure that the lubricating grease remains in good condition, the thermal balance temperature of the high-temperature end of the harmonic reducer should be below 70° C, with a temperature rise of less than 40°C.
- (7) The wear of various moving parts in the harmonic reducer is mainly influenced by the performance of the lubricating grease. Under favorable conditions, the lubricating grease should be replaced every 3000 hours of operation.

Lubricating Grease Application Requirements

WCSG, WSHG series apply grease as per the following table

Size	Grease area					Unit: g
	A	B	C		D	
			Horizontal use	Vertical use		
14	0.3	0.3	6	8	9	0.3
17	0.5	0.5	10	12	14	0.5
20	0.8	0.8	16	18	21	0.8
25	1.5	1.5	30	35	40	1.5
32	3	3	60	70	80	3

Grease area

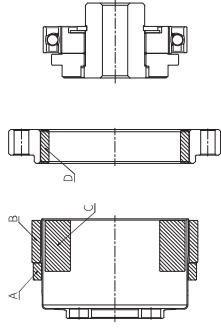

WCSG-I series

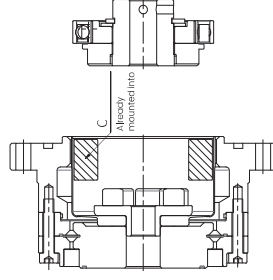

WCSG-II series

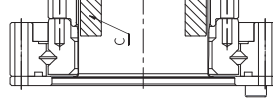

WSHG-II series

Pls. apply the grease for WSHG-III Series according to the following requirements

Amount of grease applied

Unit: g

Size	Grease area	
	C1	
14	5.5	
17	9.6	
20	10.3	
25	16	
32	26	

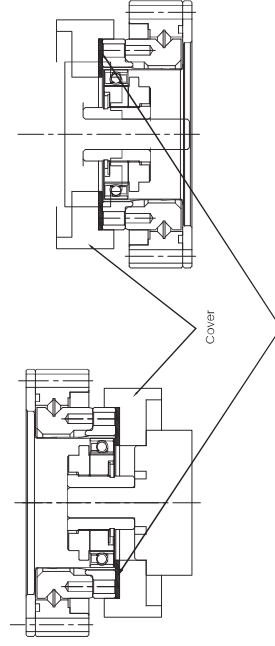
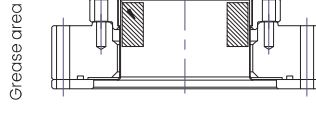

Pls. apply the grease for WSHD and WCSD Series according to the following requirements

Amount of grease applied

Unit: g

Size	Grease area			
	C			
	Horizontal use	Vertical use		
		Upward	Down	
14	3	4	5	
17	5	6	7	
20	8	9	11	
25	16	19	21	
32	36	42	48	

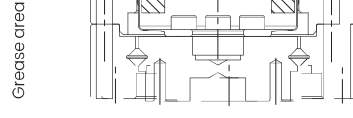

WCSD series

WSHD series

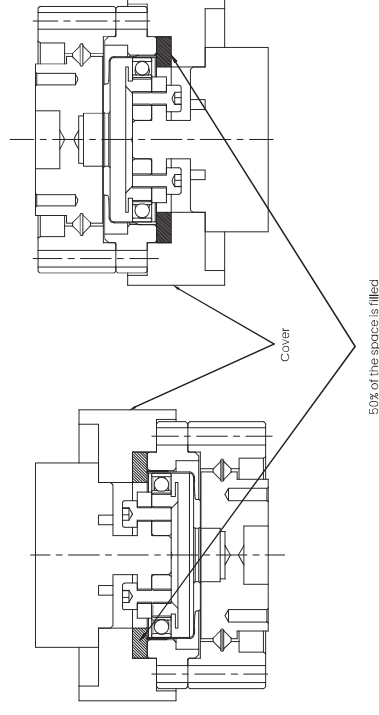

Grease Change Time

The abrasion of the moving parts of reducer is greatly affected by the performance of the grease. The performance of the grease will change according to the temperature, the higher the temperature, the faster the deterioration, so it is necessary to change the grease. As shown in the figure below, when the average load torque is lower than the rated torque, the replacement time benchmark of the grease can be determined according to the relationship between the grease temperature and the total revolutions of the wave generator. When the average load torque exceeds the rated torque, the grease replacement time benchmark is calculated by the following formula.

$$L_{GT} = L_{GTn} \times \left(\frac{T_r}{T_{av}} \right)^3$$

The formula for calculating when the average load torque exceeds the rated torque

Grease change time: L_{GTn}
(when average load torque is lower than rated torque)

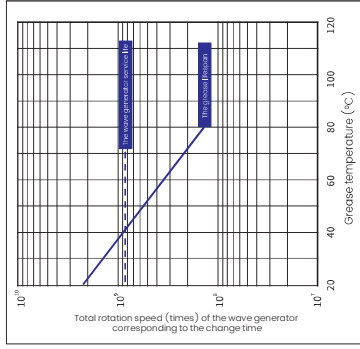

※ The service life of the wave generator indicates that the failure rate is 10%.

Warranty

WANSHSIN harmonic reducer warranty period and warranty scope is as follows:

Warranty Period

On the condition under normal assembly and lubrication state recorded in the product operation manual,

The warranty period is either one year or the product runs up to 8,000 hours.

Warranty Scope

Wanshin is responsible for the repair or replacement of the product in case of failure caused by the manufacturing defects.

But the followings are not covered:

- (1) failure is caused by improper operation or illegal use.
- (2) failure is not caused by transformation or repair not by Wanshin
- (3) failure not caused by the product.
- (4) Wanshin is not responsible for the failure caused by natural disasters.

Moreover, the warranty here refers to the warranty of this product.

The company shall not be responsible for other losses caused by the failure of the product, the man-hours and expenses related to disassembling and assembling the equipment, etc.



Precautions for safety use

 Warning	Error in operation may result in death or serious injury.
 Attention	Indicates that the wrong operation may result in injuries and property damage.
 Attention	About the scrap Please treat according to industrial waste standard. Note: when scrapping, please treat as industrial waste.

Design attentions (be sure to read the instructions when designing)

 Attention	<p>Please use under regulated conditions</p> <p>When using reducer, please comply with the following conditions.</p> <ol style="list-style-type: none"> 1. Ambient temperature: 0~40°C. 2. Do not splash water, oil, etc. 3. Non-corrosive, explosive gas. 4. No dust such as metal powder. 	<p>please install according to the specified precision</p> <ol style="list-style-type: none"> 1. Assembly method, order, please follow the product catalog. 2. Tightening method (using bolts, etc.), please follow our advice. 3. If not assembled correctly, the operation may lead to vibration, shorten the service life, precision decline, damage and other faults.
 Attention	<p>please install according to the specified precision</p> <ol style="list-style-type: none"> 1. Please design and assemble various parts correctly to ensure that they can meet the installation precision recommended in the product catalog. 2. Failure to meet the specified precision may lead to vibration, shorten service life, precision decline, damage and other faults. 	<p>Please use the specified grease</p> <ol style="list-style-type: none"> 1. Do not use the grease recommended by Wanshin may shorten the service life of the product. In addition, please change the grease according to the specified conditions. 2. The combined product has been pre-sealed with grease. Please do not mix with other greases.

Notes for use (please be sure to read the manual when running)

 Attention	<p>Please handle the products and components with care</p> <ol style="list-style-type: none"> 1. Do not use a hammer and other hard hit each component and combination unit. In addition, please make sure that there are no cracks, dents, etc. caused by falling, etc. Otherwise, the product will be damaged. 2. Performance cannot be guaranteed when used in a damaged state. It may also cause damage and other faults. 	<p>When in use, do not exceed the allowable torque</p> <ol style="list-style-type: none"> 1. Apply torque do not exceed the maximum allowable torque of the moment. Otherwise the bolts in the tightening part may become loose, shake, and damage, leading to product failure. 2. If the output shaft is directly connected to the joint arm, the output shaft cannot be controlled.
 Attention	<p>Do not change spare parts</p> <ol style="list-style-type: none"> 1. The parts of the product are made of matching processing. When used in conjunction with other spares, there is no guarantee that a particular performance will be achieved. 	<p>Do not disassemble the combined product</p> <ol style="list-style-type: none"> 1. It is strictly prohibited to disassemble and reassemble combined products. Otherwise its original performance will not be restored.

Use of grease	
 Warning	<p>stallation precautions</p> <ol style="list-style-type: none"> 1. Splashing into the eye may cause inflammation. When operating, please wear protective glasses to avoid splashing into the eyes. 2. Skin contact may cause inflammation. When operating, please wear protective gloves to avoid contact with the skin. 3. Do not swallow (Can cause diarrhea, vomiting, etc.). 4. Be careful not to cut your finger when opening the container, please wear protective gloves. 5. Please keep it out reach of children.
 Attention	<p>Emergency Treatment</p> <ol style="list-style-type: none"> 1. In case of splash into the eyes, rinse immediately with water for 15 minutes and receive medical treatment. 2. In case of contact with skin, wash thoroughly with water and soap. 3. If swallowed, do not force to vomit, should immediately accept medical treatment.
	<p>Storage Method</p> <ol style="list-style-type: none"> 1. After use, please seal it to prevent dust, moisture and other mixed. Please keep it in the shade, away from direct sunlight. 2. For long-term inventory of products, it is recommended to confirm whether the performance and rust prevention is good. 3. Please refer to the delivery drawing for details of surface treatment.
	<p>Disposal of waste oil and waste containers</p> <ol style="list-style-type: none"> 1. The decree provides a treatment that users are obliged to implement. Please handle it correctly according to relevant laws and regulations if you are not clear, please consult Wanshin. 2. Do not put pressure on empty containers, pressure may cause it to crack. 3. Do not weld, heat, open or cut the container, otherwise there could be an explosion and the remains inside could catch fire.