

User Manual

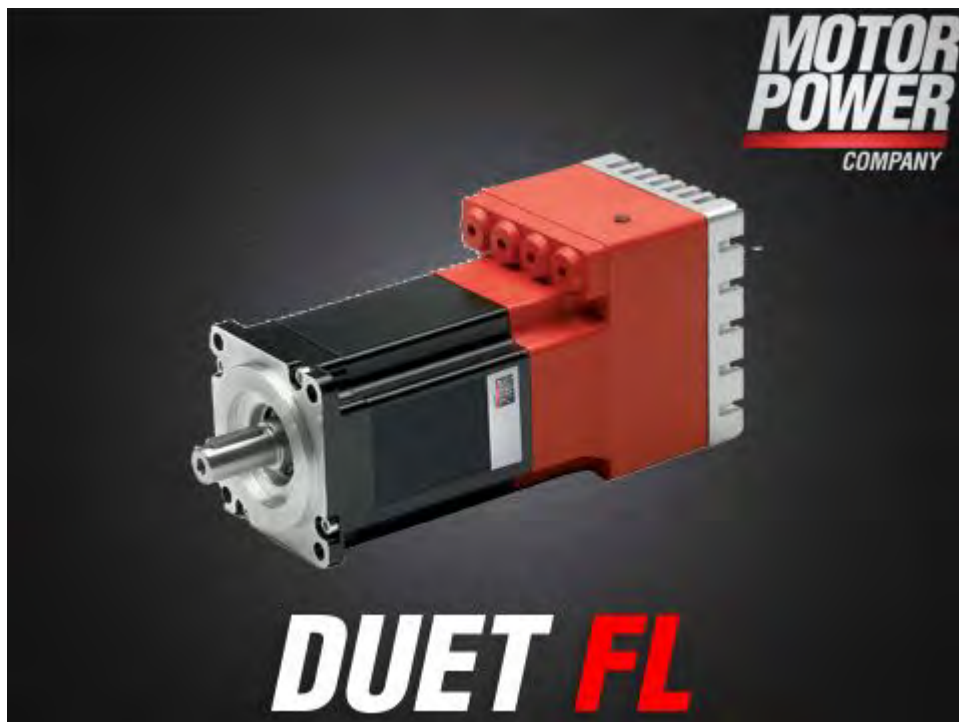

DUET_FL 48/10

Copyrights

© 2006 Motor Power Company. All rights reserved.

The information and data in this document have been composed to the best of our knowledge. However, deviations between the document and the product cannot be excluded entirely. For the devices and the corresponding software in the version handed out to the customer, Motor Power Company guarantees the contractual use in accordance with the user documentation. In the case of serious deviations from the user documentation, Motor Power Company has the right and the obligation to repair, unless it would involve an unreasonable effort. A possible liability does not include deficiencies caused by deviations from the operating conditions intended for the device and described in the user documentation.

Motor Power Company does not guarantee that the products meet the buyer's demands and purposes or that they work together with other products selected by the buyer. Motor Power Company does not assume any liability for damages resulting from the combined use of its products with other products or resulting from improper handling of machines or systems.

Motor Power Company reserves the right to modify, amend, or improve the document or the product without prior notification.

This document may, neither entirely nor in part, be reproduced, translated into any other natural or machine-readable language nor transferred to electronic, mechanical, optical or any other kind of data media, without expressive authorization by the author.

Trademarks

Any product names in this document may be registered trademarks. The sole purpose of any trademarks in this document is the identification of the corresponding products.

Revision Log			
Author:		Motor Power Company	
Manual name:		User Manual "DUET_FL 48/10"	
File name:		UserManual_DUET_FL_V10.doc	
Storage location of the file:			
No.	Description	Revision index	Date of change
001	First authorized version	1.0	24.06.2005
002	Revision: Extension to DUET_FL and to firmware 3.0	1.1	15.05.2006

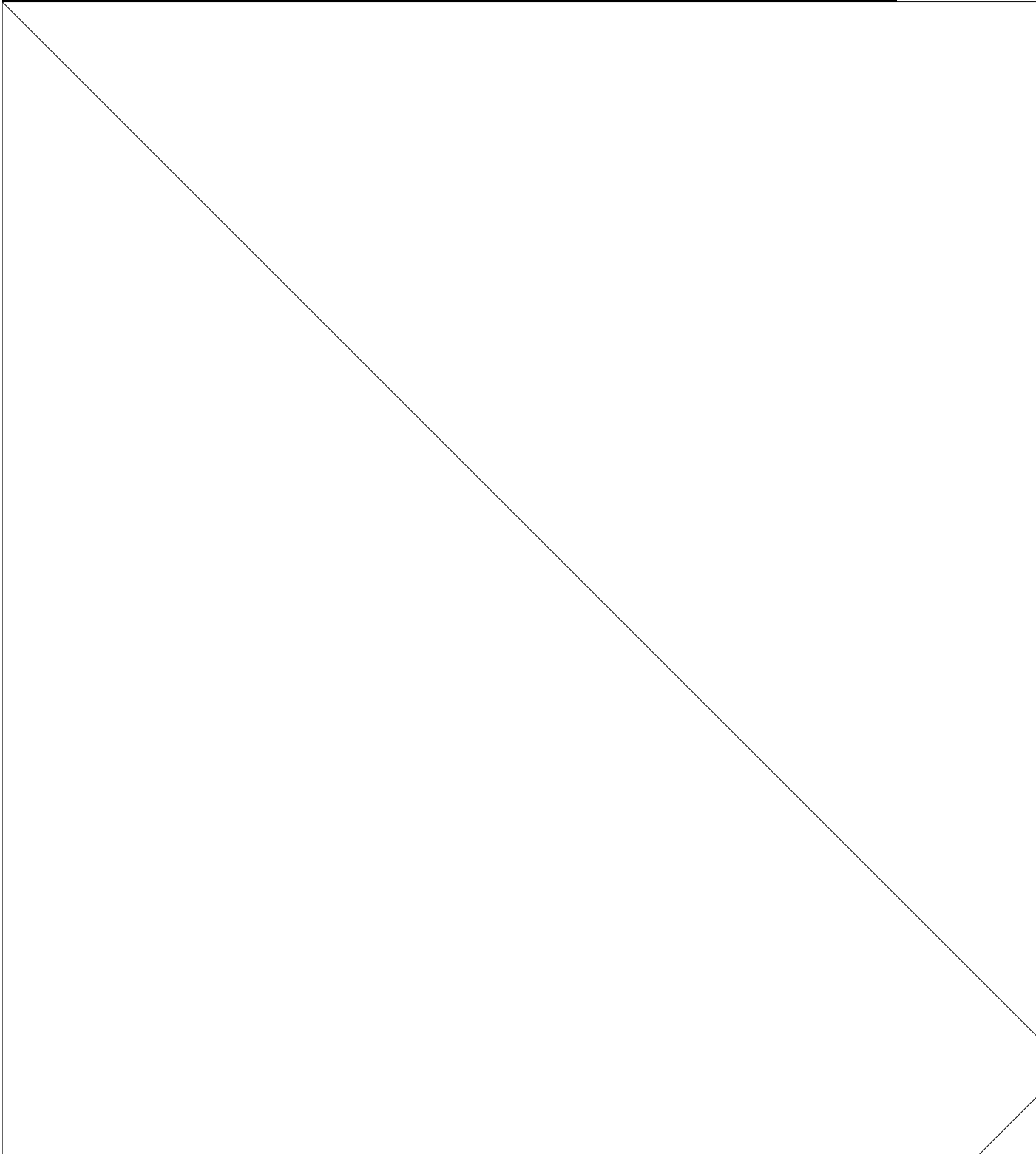

TABLE OF CONTENTS:

TABLE OF CONTENTS:	5
List of Figures:	12
Figure 1: Current controller step response 38	13
Figure 2: Speed controller 49	13
Figure 3: Speed controller too soft 52	13
Figure 4: Speed controller too hard 52	13
Figure 5: Speed controller set correctly 52	13
Figure 6: Positioning control block diagram 57	13
Figure 7: Speed controller optimization 60	13
Figure 8: Time-optimal and jerk-limited positioning 64	13
Figure 9: Homing run to the negative limit switch with index pulse evaluation 67	13
Figure 10: Homing run to the positive limit switch with index pulse evaluation 67	13
Figure 11: Homing to the negative limit switch 68	13
Figure 12: Homing to the positive limit switch 68	13
Figure 13: Homing run referred only to the index pulse 68	13
Figure 14: Homing run to the negative stop with index pulse evaluation 69	13
Figure 15: Homing run to the positive stop with index pulse evaluation 69	13
Figure 16: Homing to the negative stop 69	13
Figure 17: Homing to the positive stop 70	13
Figure 18: Course program - Position branch 78	13
Figure 19: Position branch time diagram 78	13
Figure 20: Course program - Branch (Line) 79	13
Figure 21: Branch (Line) time diagram 80	13
Figure 22: Level test course program 80	13
Figure 23: Level test time diagram 81	13
Figure 24: Teaching process of a target position 86	13
Figure 25: Coupled incremental encoder emulation 90	13
Figure 26: Holding brake time response 92	13
Figure 27: Safe zero 93	13
Figure 28: Online parameterization 147	13
Figure 29: Offline parameterization 151	13
Figure 30: Arrangement of DUET_FL pin-and-socket connectors - top view of electronics module 162	13

Figure 31: Housing dimensions 163.....	13
Figure 32: DUET_FL application example - Synchronous servo motor in the power range of 500 W with a DUET_FL servo positioning controller and a gearbox for a steering application. 164.....	13
Figure 33: Numbered pins of X1 DUET_FL 48/10 165.....	14
Figure 34: Angle encoder connector 166.....	14
Figure 35: Motor cable connection 167.....	14
Figure 36: Holding brake connection 167.....	14
Figure 37: Technology module connection 168.....	14
Figure 38: Numbered pins of [X1] DUET_FL 48/10 IC 169.....	14
Figure 39: Numbered pins of [X1] DUET_FL 48/10 FB 170.....	14
Figure 40: Brake resistance connection 172.....	14
Figure 41: Position and numbered pins [X401], [X402] and [X5] at DUET_FL 48/10 FB 173.....	14
Figure 42: Position and connection technology module 175.....	14
Figure 43: Connection to power supply, control and motor 177.....	14
Figure 44: Wiring example for the power supply and EMERGENCY OFF / EMERGENCY STOP 182.....	14
Figure 45: Connection of the DUET_FL to the power supply unit, shield connection on the chassis 186.....	14
Figure 46: Connection of the DUET_FL to the power supply unit, shield connection via cable 186.....	14
Table 1: Scope of supply 20.....	16
Table 2: Additional parametrization program 20.....	16
Table 3: DUET_FL 48/10 accessories 21.....	16
Table 4: DUET_FL 48/10 IC and DUET_FL 48/10 FB accessories 21.....	16
Table 5: Angle encoder parameters 35.....	16
Table 6: Display mode 43.....	16
Table 7: Error elimination: Speed control 49.....	16
Table 8: Course program: Assignment of the digital inputs 76.....	16
Table 9: Course program: Configuration of the digital inputs (new I/O configuration) 76.....	16
Table 10: Available position sets if the course program is active and the Course/Posi input = 0 77.....	16
Table 11: DUET_FL 48/10 digital inputs - possible combinations 84.....	16
Table 12: DUET_FL 48/10 IC digital inputs - possible combinations 84.....	16
Table 13: DUET_FL 48/10 FB digital inputs - possible combinations 84.....	16
Table 14: Digital inputs - assignment 85.....	16

Table 15: Tipp & Teach: Configuration of the digital inputs 87	16
Table 16: Error overview 106	16
Table 17: Control elements 113	16
Table 18: Directories 115	16
Table 19: Recovering problems with serial communication 118	16
Table 20: Command syntax of communication objects 126	16
Table 21: Meaning of letters in the command syntax 126	16
Table 22: RS232 command syntax 127	16
Table 23: Meaning of letters in the command syntax 127	16
Table 24: List of all communication objects 128	16
Table 25: List of basic units 136	16
Table 26: Online/Offline activation 153	16
Table 27: Pin assignment of connector [X1] 167	16
Table 28: Pin assignment of connector [X2] 168	16
Table 29: Pin assignment of connector [X301 – X303] 169	16
Table 30: Pin assignment of connector [X3] 169	16
Table 31: Pin assignment of connector [X8] 170	16
Table 32: Pin assignment of connector [X1] 171	16
Table 33: Pin assignment of connector [X1] 172	16
Table 34: Pin assignment of connector [X304], [X305] 174	16
Table 35: Pin assignment of connector [X401] and [X402] 175	17
Table 36: Pin assignment of connector [X5] 176	17
Table 37: Pin assignment to set up an RS232 adapter cable for connection to a PC/notebook 176	17
Table 38 (A): Pin assignment of connector [X8] 177	17
Table 39: Description of the requirements to be met for the categories in accordance with EN 954-1 181	17
Table 40: EMERGENCY OFF and EMERGENCY STOP according to EN 60204-1 182	17
Table 41: Stop categories 182	17
1General	18
Symbols used in this manual.....	18
Features and area of application of the DUET_FL.....	19
Area of application and intended use.....	19
DUET_FL features.....	19
DUET_FL ServoCommander™ features.....	21
Basic information.....	21
1.1.1DUET_FL ServoCommander™ features.....	21
Hardware and software requirements	21

Documentation.....	22
1.2 Supply state and scope of supply.....	22
2 Safety notes for electrical drives and controllers	24
General notes.....	24
2.1 Danger resulting from misuse	25
Safety notes.....	26
General safety notes.....	26
Safety notes for assembly and maintenance	27
Protection against contact with electrical parts	28
2.1.1 Protection against electrical shock by means of protective extra-low voltage (PELV)	29
Protection against dangerous movements.....	29
Protection against contact with hot parts	30
2.1.2 Protection during handling and assembly.....	30
Preparation for commissioning.....	32
System overview.....	32
Connecting the DUET_FL to the control system.....	32
3.1 Installation and start of the DUET_FL ServoCommanderTM.....	32
Initial parameterization of the controller.....	33
Commissioning	33
Parameter set in the delivery state.....	33
Manual commissioning.....	33
Parameterization using the motor database.....	34
Basic parameterization of new motors.....	35
Angle encoders.....	35
3.1.1 Motor data	38
Power stage.....	40
3.1.2 Current controller.....	41
DC bus monitoring.....	42
Motor temperature monitoring.....	43
Configuring application parameters.....	44
General configuration.....	44
Configuring the display units.....	44
3.2 Defining input limits.....	46
3.3 Selecting safety parameters.....	47
Configuring the controller enable logic.....	48
Configuring the limit switch polarity.....	49
Setting the direction of rotation.....	50
Making the system ready for operation, enabling the power stage.....	50
4 Current and speed control.....	52
Function overview.....	52
Speed-controlled mode.....	54
4.1.1 Optimizing the speed controller.....	54
Torque-controlled mode.....	57
4.2 Setpoint assignment through setpoint selectors.....	57
Speed-controlled mode.....	58
Torque-controlled mode.....	58
4.2.1 Setpoint assignment through RS232.....	59
Setpoint ramp.....	59

Torque limitation.....	60
5 Positioning mode.....	61
5.1 Function overview.....	61
Activating the operating mode.....	62
5.2 Configuring and optimizing the position controller.....	63
Position controller optimization.....	64
Global positioning settings.....	65
Parametrizing position sets.....	66
Setting of digital outputs	70
Homing 70	
Parameterizing the homing run.....	74
Course program	77
Creating a course program.....	79
Course program options.....	80
End of program.....	81
Position branch.....	81
Branch (Line).....	83
Level test84	
Debugging a course program.....	85
Function of the inputs and outputs.....	86
5.3 Digital inputs DIN0 to DIN9.....	86
Configuring the digital inputs.....	88
5.4 Extended function of the digital inputs (Tipp & Teach).....	88
8.2.1 Teaching positions.....	89
5.5 Digital outputs DOUT0 to DOUT3.....	91
Configuring the digital outputs.....	91
Configuring the messages for the digital outputs.....	92
Incremental encoder emulation through DOUT1 and DOUT2.....	93
5.6 Holding brake DOUT3.....	95
Brake functions.....	95
Analog inputs AIN0 and AIN1.....	96
Analog output AMON.....	98
6 Communication interfaces.....	99
Control through the CAN bus.....	99
Function overview.....	99
6.1.1 Processing of CAN messages.....	100
6.1.2 Configuring the CANopen communication parameters.....	100
Control through the serial interface.....	101
Function overview.....	101
6.1.3 Serial communication through DUET_FL ServoCommander™.....	102
Configuring the RS232 communication parameters.....	102
Transfer window	103
Communication window for RS232 transmission.....	103
Control through the technology interface.....	104
Error messages/Error table.....	105
Error monitoring in the DUET_FL.....	105
6.1.4 Overcurrent and short-circuit monitoring.....	105
DC bus voltage monitoring.....	105
Logic supply monitoring.....	106

Heat sink temperature monitoring.....	106
Motor monitoring.....	106
Motion sequence monitoring.....	107
Additional internal monitoring functions.....	107
Operating hour meter.....	107
Error overview.....	107
Error display in DUET_FL ServoCommanderTM.....	112
6.2Error management	113
Appendix.....	114
DUET_FL ServoCommanderTM operating instructions.....	114
Standard buttons.....	114
Numerical input fields	114
Control elements	115
6.2.1 Display of setpoints and actual values.....	115
6.2.2Standard window.....	116
Directories.....	117
6.2.3Communication via communication objects	117
Quitting the program.....	118
Setting up the serial communication.....	119
Fast access via the tool bar.....	122
Using the oscilloscope function.....	123
Oscilloscope settings.....	123
Oscilloscope window.....	125
6.3Serial communication protocol.....	128
List of communication objects.....	130
Basic units.....	138
11.7.2 Bit configuration for command word / status word / error word.....	139
Extended options in the "Display units" menu.....	143
Configuration of user-defined display units.....	143
Decimal places.....	144
Direct input of distance, speed and acceleration units.....	144
Course program: Examples.....	145
6.3.1Example 1: Linear linking of positions.....	145
Example 2: Linear linking of positions and setting of a digital output.....	146
Example 3: Setting and inquiring digital inputs and outputs; infinite loops.....	147
Timing diagrams.....	147
11.10.1Switch-on sequence.....	148
Positioning / Destination reached.....	149
Speed signal	149
Quit error150	
Limit switch.....	150
Parameter set management.....	151
General 151	
Loading and saving parameter sets.....	152
Loading firmware into the DUET_FL / firmware update.....	156
11.13.1Loading the firmware	156
Technical data.....	159
Ambient conditions and qualification.....	159
11.13.2Dimensions and weight.....	159
11.13.3Performance data.....	159
Motor temperature monitoring.....	161
11.13.4Motor connection data [X301 – X303].....	161
11.13.5Resolver [X2].....	161

11.13.6	Analog Hall encoder evaluation [X2].....	162
	Hiperface encoder evaluation [X2].....	162
11.13.7	Incremental encoder evaluation [X2] – only DUET_FL 48/10 FB.....	162
	Six-Step Hall sensor and block commutation [X2].....	163
11.13.8	RS232 [X1].....	163
11.13.9	CAN-Bus [X1].....	163
11.13.10	Analog inputs and outputs [X1].....	163
11.13.11	Digital inputs and outputs [X1].....	164
11.13.12	Incremental encoder output [X1].....	164
11.14.	Mechanical installation.....	165
	Important notes.....	165
	Position and connection of the pin-and-socket connectors.....	166
	Housing dimensions.....	167
	Installation.....	168
	Connectors at the DUET_FL 48/10.....	169
	Connection: Power supply and I/O [X1].....	169
11.14.1	Connection: Angle encoder [X2].....	170
	Connection: Motor [X301 – X303].....	171
11.14.2	Connection: Holding brake [X3].....	171
	Connection: Extension port [X8].....	172
	Connectors at the DUET_FL 48/10 IC.....	173
	Connection: Power supply and I/O [X1].....	173
11.14.3	Connection: Motor, encoder, brake, extensions.....	174
	Connectors at the DUET_FL 48/10 FB.....	174
	Connection: Power supply and I/O [X1].....	174
	Connection: Motor, encoder, brake, extensions.....	175
11.18.3	Brake resistance connection [X304 – X305].....	176
	Connection: CAN bus [X401] and [X402].....	177
11.18.5	Connection: Serial parameterization interface [X5].....	178
	Connection: Extension port [X8].....	179
	Electrical installation of the DUET_FL 48/10.....	181
	Connection to Power Supply and control in system.....	181
	EMERGENCY OFF / EMERGENCY STOP – terminology and standards.....	183
	EMERGENCY OFF / EMERGENCY STOP wiring examples.....	185
11.20	Notes concerning safe and EMC-compliant installation.....	188
	Definitions and terminology.....	188
	General information concerning EMC.....	188
11.20.1	EMC ranges: First and second environment.....	188
	Connection between the DUET_FL and the motor.....	189
11.20.2	Connection between the DUET_FL and the power supply unit.....	189

List of Figures:

Figure 1: Current controller step response.....	42
Figure 2: Speed controller.....	53
Figure 3: Speed controller too soft.....	56
Figure 4: Speed controller too hard.....	56
Figure 5: Speed controller set correctly.....	56
Figure 6: Positioning control block diagram.....	61
Figure 7: Speed controller optimization.....	64
Figure 8: Time-optimal and jerk-limited positioning.....	68
Figure 9: Homing run to the negative limit switch with index pulse evaluation	71
Figure 10: Homing run to the positive limit switch with index pulse evaluation	71
Figure 11: Homing to the negative limit switch.....	72
Figure 12: Homing to the positive limit switch.....	72
Figure 13: Homing run referred only to the index pulse.....	72
Figure 14: Homing run to the negative stop with index pulse evaluation.....	73
Figure 15: Homing run to the positive stop with index pulse evaluation.....	73
Figure 16: Homing to the negative stop.....	73
Figure 17: Homing to the positive stop.....	74
Figure 18: Course program - Position branch.....	82
Figure 19: Position branch time diagram.....	82
Figure 20: Course program - Branch (Line).....	83
Figure 21: Branch (Line) time diagram.....	84
Figure 22: Level test course program.....	84
Figure 23: Level test time diagram.....	85
Figure 24: Teaching process of a target position.....	90
Figure 25: Coupled incremental encoder emulation.....	94
Figure 26: Holding brake time response.....	96
Figure 27: Safe zero.....	97
Figure 28: Online parameterization.....	151
Figure 29: Offline parameterization.....	155
Figure 30: Arrangement of DUET_FL pin-and-socket connectors - top view of electronics module.....	166
Figure 31: Housing dimensions.....	167
Figure 32: DUET_FL application example - Synchronous servo motor in the power range of 500 W with a DUET_FL servo positioning controller and a gearbox for a steering application.....	168

Figure 33: Numbered pins of X1 DUET_FL 48/10.....	169
Figure 34: Angle encoder connector.....	170
Figure 35: Motor cable connection.....	171
Figure 36: Holding brake connection.....	171
Figure 37: Technology module connection.....	172
Figure 38: Numbered pins of [X1] DUET_FL 48/10 IC.....	173
Figure 39: Numbered pins of [X1] DUET_FL 48/10 FB.....	174
Figure 40: Brake resistance connection.....	176
Figure 41: Position and numbered pins [X401], [X402] and [X5] at DUET_FL 48/10 FB.....	177
Figure 42: Position and connection technology module.....	179
Figure 43: Connection to power supply, control and motor.....	181
Figure 44: Wiring example for the power supply and EMERGENCY OFF / EMERGENCY STOP	186
Figure 45: Connection of the DUET_FL to the power supply unit, shield connection on the chassis.....	190
Figure 46: Connection of the DUET_FL to the power supply unit, shield connection via cable.....	190

List of Tables:

Table 1: Scope of supply	22
Table 2: Additional parametrization program.....	22
Table 3: DUET_FL 48/10 accessories.....	23
Table 4: DUET_FL 48/10 IC and DUET_FL 48/10 FB accessories.....	23
Table 5: Angle encoder parameters.....	37
Table 6: Display mode.....	45
Table 7: Error elimination: Speed control.....	51
Table 8: Course program: Assignment of the digital inputs.....	78
Table 9: Course program: Configuration of the digital inputs (new I/O configuration).....	78
Table 10: Available position sets if the course program is active and the Course/Posi input = 0.....	79
Table 11: DUET_FL 48/10 digital inputs - possible combinations.....	86
Table 12: DUET_FL 48/10 IC digital inputs - possible combinations.....	86
Table 13: DUET_FL 48/10 FB digital inputs - possible combinations.....	86
Table 14: Digital inputs - assignment.....	87
Table 15: Tipp & Teach: Configuration of the digital inputs.....	89
Table 16: Error overview.....	108
Table 17: Control elements	115
Table 18: Directories.....	117
Table 19: Recovering problems with serial communication.....	120
Table 20: Command syntax of communication objects.....	128
Table 21: Meaning of letters in the command syntax.....	128
Table 22: RS232 command syntax.....	129
Table 23: Meaning of letters in the command syntax.....	129
Table 24: List of all communication objects.....	130
Table 25: List of basic units.....	138
Table 26: Online/Offline activation.....	155
Table 27: Pin assignment of connector [X1].....	169
Table 28: Pin assignment of connector [X2].....	170
Table 29: Pin assignment of connector [X301 – X303].....	171
Table 30: Pin assignment of connector [X3].....	171
Table 31: Pin assignment of connector [X8].....	172
Table 32: Pin assignment of connector [X1].....	173
Table 33: Pin assignment of connector [X1].....	174
Table 34: Pin assignment of connector [X304], [X305].....	176

Table 35: Pin assignment of connector [X401] and [X402].....	177
Table 36: Pin assignment of connector [X5].....	178
Table 37: Pin assignment to set up an RS232 adapter cable for connection to a PC/notebook.....	178
Table 38 (A): Pin assignment of connector [X8].....	179
Table 39: Description of the requirements to be met for the categories in accordance with EN 954-1.....	183
Table 40: EMERGENCY OFF and EMERGENCY STOP according to EN 60204-1.....	184
Table 41: Stop categories.....	184

1 General

Symbols used in this manual



Information
Important information and notes.



Caution!
Non-observance may result in severe property damage.



DANGER !
Non-observance may result in **property damage** and **personal injuries**.



Caution! Dangerous voltage.
The safety note indicates the possibility of a highly dangerous voltage.

Features and area of application of the DUET_FL

Area of application and intended use

The DUET_FL servo positioning controller was designed for the decentralized control of three-phase magneto-electric synchronous machines. Thanks to numerous options for feedback and to various different control methods, such as "block commutation" and "sine commutation", the controller can be adapted optimally to the motor characteristics.

Normally, it is mounted directly on the motor. However, it is also possible to detach the DUET_FL from the motor and to connect it to the motor using a short, shielded cable. Further information concerning the installation can be found in the appendix in *chapter 11.14 Mechanical installation*.

The DUET_FL servo positioning controller is supplied with power through a power supply unit or a battery with 24 V DC or 48 V DC protective low voltage. At the motor connection, it supplies the synchronous machine with a pulse-width-modulated, symmetrical, 3-phase rotating field with variable frequency, current and voltage.

The DUET_FL was designed for a continuous torque, speed and position control in typical industrial applications such as:

- Positioning and feeding drives in machines
- Palletizing and packaging machines
- Wood-processing machines
- Reeling drives, wire drawing drives etc.
- Drives in tightening and press-fitting applications
- Conveying applications

Prior to using the DUET_FL controller in special areas of application with particularly high normative requirements, e.g. medical technology or avionics, requiring particularly high levels of device safety, the user has to check whether the DUET_FL fulfils the corresponding standards. In case of doubt, please contact your local distributor.

The DUET_FL may only be used if the operating conditions described and the technical data of the controller stated in the appendix in *chapter Technical data* are complied with. In addition, all relevant regulations concerning installation, start-up, dismantling and maintenance have to be complied with.

DUET_FL features

The DUET_FL has the following features:

- ❖ Compact design. The housing (closed on five sides) can be mounted on the motor either directly or using an adapter plate.
- ❖ Highly precise control thanks to a high-quality sensor system.

- ❖ Full integration of all components for the controller and power section, including an RS232 interface for PC communication and a CANopen interface for integration in automation systems.
- ❖ Integrated universal rotary encoder evaluation for the following encoder types:
 - Resolvers
 - Analog Hall sensors with SIN/COS signals (upon request)
 - High-resolution Stegmann incremental encoders, absolute encoders with HIPERFACE
 - Six-step Hall encoders
 - Incremental encoders with commutation signals
- ❖ Integrated driver stage for 24 V holding brakes
- ❖ Compliance with current CE and EN standards without any additional external filter measures
- ❖ EMC-optimized metal housing for direct mounting on the motor. The device has an IP54 degree of protection. Depending on the mounting methods and the seals used, a degree of protection up to IP67 can be reached.
- ❖ Integration of all filters in the unit required for compliance with the EMC regulations (industrial environment), e.g. filters for the 24 V supply and the inputs and outputs.
- ❖ Can be used as a torque controller, speed controller or position controller.
- ❖ Integrated positioning control with extensive functionality in accordance with "CAN in Automation (CiA) DSP402" and numerous additional application-specific functions.
- ❖ Jerk-free or time-optimal positioning, relative or absolute with regard to a reference point.
- ❖ Point-to-point positioning with and without spot tracing.
- ❖ Speed- and angle-synchronous operation with an electronic gearbox via field bus.
- ❖ Numerous homing methods.
- ❖ Changeable clock frequency for the output stage.
- ❖ Integrated course program to create simple positioning sequences with or without dependence on digital inputs.
- ❖ Programmable digital outputs.
- ❖ High-resolution 12-bit analog input.
- ❖ User-friendly parametrization using the DUET_FL ServoCommander™ PC program.
- ❖ Automatic motor identification.
- ❖ Easy connection to a superordinated control system, e.g. to a PLC on the I/O level or via a field bus.
- ❖ Technology slot for extensions, e.g. field bus connections (only DUET_FL 48/10)
- ❖ I²t monitoring system to limit the average power loss in the power stage and in the motor.
- ❖ Integrated brake chopper (only DUET_FL 48/10)
- ❖ Separate RS232 and field bus connection (only DUET_FL 48/10)

DUET_FL ServoCommander™ features

Basic information

The parametrization program ensures the comfortable parametrization of the DUET_FL servo positioning controller. You adapt the DUET_FL servo positioning controller optimally to your application using the parametrization software.

The firmware of the DUET_FL servo positioning controller must match the parametrization software. This means that following an extension of functionality in a new firmware version, you also require the corresponding new version of the parametrization program.



You cannot parameterize any other Motor Power Company devices using this parameterization software.

1.1.1 DUET_FL ServoCommander™ features

The parametrization program has the following features:

- ❖ Parametrization of the DUET_FL servo positioning controller.
- ❖ Configuration of all parameters using the PC.
- ❖ Display of operating quantities.
- ❖ Loading of new firmware versions.
- ❖ Loading and saving of parameter sets.
- ❖ Printing of parameter sets.
- ❖ Offline parametrization.
- ❖ Oscilloscope function.
- ❖ Languages: German, English, French.
- ❖ Windows-conform operation.
- ❖ Course program.

Hardware and software requirements

Requirements to be met for installing the parametrization program:

- ❖ IBM-compatible PC-AT, Pentium II processor or higher with at least 32 MB main memory and at least 10 MB free hard-disk memory.
- ❖ Operating system Windows® 95, Windows® 98, Windows NT®, Windows 2000, Windows XP®
- ❖ CD-ROM drive.
- ❖ Free serial interface.

Documentation

This software manual is intended to ensure safe working with the DUET_FL ServoCommander™ parameterization program for the DUET_FL servo positioning controller.

Further information can be found in the following manuals of the DUET_FL product range:

- ❖ **CANopen manual "CanOpen_Manual_DUET_FL"**: Description of the implemented CANopen protocol in accordance with DSP402.
- ❖ **Mounting instructions "Mounting instructions_DUET_FL"**: Instruction manual concerning the installation of the DUET_FL servo positioning controller.

The servo positioning controller has a FLASH program memory allowing the operating software of the controller to be updated even after it has been delivered and installed in a machine. The manufacturer is continuously revising and extending the operating software of the controller to meet a wide range of customer requirements.

	<p>The information stated in this manual refers to the following versions of the controller operating software and of the parametrization program:</p> <p>DUET_FL servo positioning controller firmware: Version 3.0</p> <p>Parametrization software: Version 2.1</p>
---	---

1.2 Supply state and scope of supply

The supply comprises:

Table 1: Scope of supply

1x	DUET_FL servo positioning controller Supply state: Default parameter set for operating the resolver motor.
----	--

Table 2: Additional parametrization program

1x	DUET_FL ServoCommander Windows® parametrization program German/English/French
----	---

Mating connectors for power, control or rotary encoder connections are not part of the standard scope of supply. They can be ordered as accessories:

Table 3: DUET_FL 48/10 accessories

1x	Connector set: AMP pin-and-socket connector		Motor Power Company part number: 9019-0200-00	
	Content:	1x		16-pin AMP mating connector, incl. crimp contacts
		1x		16-pin mating connector for angle encoder, incl. crimp contacts
		1x		2-pin mating connector for holding brake, incl. crimp contacts
1x	DUET_FL control panel with AMP pin-and-socket connector		Motor Power Company part number: 9019-0300-00	

Table 4: DUET_FL 48/10 IC and DUET_FL 48/10 FB accessories

1x	Connector set: Phoenix pin-and-socket connector (been suitable for DUET_FL IC and DUET_FL FB)			
	Content:	1x		18-pin Phoenix mating connector comprising: VARICON mating connector, sleeve frame and sleeve housing
		1x		16-pin mating connector for angle encoder, incl. crimp contacts
		1x		2-pin mating connector for holding brake, incl. crimp contacts
1x	DUET_FL IC control panel with Phoenix pin-and-socket connector			
1x	DUET_FL FB control panel with Phoenix pin-and-socket connector			
1x	RS232 connecting cable for DUET_FL 48/10 FB Assembled connecting cable for the controller parameter configuration, length approx. 150 cm, M8 circular connector for connection to the controller, DSUB9 connector for connection to the COM port of the PC.			
1x	Braking resistor for DUET_FL 48/10 FB Plate resistor, Metallux PLR 250, 5 $\Omega \pm 10\%$, 100 W, dimensions 55 mm x 43 mm, height: 1.5 mm, height in the area of the connecting cable 4 mm, with strands l = 100 mm			

2 Safety notes for electrical drives and controllers

General notes



In the case of damage resulting from non-compliance of the safety notes in this manual Motor Power Company Meßgeräte und Elektronik GmbH will assume any liability.

If the documentation in the language at hand is not understood accurately, please contact and inform your supplier.

Sound and safe operation of the servo drive controller requires proper and professional transportation, storage, assembly and installation as well as proper operation and maintenance. Only trained and qualified personnel may handle electrical devices:

In the sense of this product manual or the safety notes on the product itself are persons who are sufficiently familiar with the setup, assembly, commissioning and operation of the product as well as all warnings and precautions as per the instructions in this manual and who are sufficiently qualified in their field of expertise:

- ❖ Education and instruction or authorization to switch devices/systems on and off and to ground them as per the standards of safety engineering and to efficiently label them as per the job demands.
- ❖ Education and instruction as per the standards of safety engineering regarding the maintenance and use of adequate safety equipment.
- ❖ First aid training.

The following notes must be read prior to the initial operation of the system to prevent personal injuries and/or property damages:



These safety notes must be complied with at all times.



Do not try to install or commission the servo drive controller before carefully reading all safety notes for electrical drives and controllers contained in this document. These safety instructions and all other user notes must be read prior to any work with the servo drive controller.



In case you do not have any user notes for the servo drive controller, please contact your sales representative. Immediately demand these documents to be sent to the person

responsible for the safe operation of the servo drive controller.



If you sell, rent and/or otherwise make this device available to others, these safety notes must also be included.



The user must not open the servo drive controller for safety and warranty reasons.



Professional control process design is a prerequisite for sound functioning of the servo drive controller!



DANGER!

Inappropriate handling of the servo drive controller and non-compliance of the warnings as well as inappropriate intervention in the safety features may result in property damage, personal injuries, electric shock or in extreme cases even death.

2.1 Danger resulting from misuse



DANGER!

High electrical voltages and high load currents!

Danger to life or serious personal injury from electrical shock!



DANGER!

High electrical voltage caused by wrong connections!

Danger to life or serious personal injury from electrical shock!



DANGER!

Surfaces of device housing may be hot!

Risk of injury! Risk of burning!



DANGER!

Dangerous movements!

Danger to life, serious personal injury or property damage due to unintentional movements of the motors!

Safety notes

General safety notes



The servo drive controller corresponds to IP54 class of protection as well as pollution level 1. Make sure that the environment corresponds to this class of protection and pollution level.



Only use replacements parts and accessories approved by the manufacturer.



The devices must be connected to the mains supply as per EN regulations, so that they can be cut off the mains supply by means of corresponding separation devices (e.g. main switch, contactor, power switch).



Gold contacts or contacts with a high contact pressure should be used to switch the control contacts.



Preventive interference rejection measures should be taken for control panels, such as connecting contactors and relays using RC elements or diodes.



The safety rules and regulations of the country in which the device will be operated must be complied with.



The environment conditions defined in the product documentation must be kept. Safety-critical applications are not allowed, unless specifically approved by the manufacturer.



For notes on installation corresponding to EMC, please refer to *chapter 11.20 Notes concerning safe and EMC-compliant installation*. The compliance with the limits required by national regulations is the responsibility of the manufacturer of the machine or system.



The technical data and the connection and installation conditions for the servo drive controller are to be found in this product manual and must be met.



DANGER!

The general setup and safety regulations for work on power installations (e.g. DIN, VDE, EN, IEC or other national and international regulations) must be complied with.

Non-compliance may result in death, personal injury or serious property damages.



Without claiming completeness, the following regulations and others apply:

VDE 0100	Regulations for the installation of high voltage (up to 1000 V) devices
EN 60204	Electrical equipment of machines
EN 50178	Electronic equipment for use in power installations

Safety notes for assembly and maintenance

The appropriate DIN, VDE, EN and IEC regulations as well as all national and local safety regulations and rules for the prevention of accidents apply for the assembly and maintenance of the system. The plant engineer or the operator is responsible for compliance with these regulations:



The servo drive controller must only be operated, maintained and/or repaired by personnel trained and qualified for working on or with electrical devices.

Prevention of accidents, injuries and/or damages:



Additionally secure vertical axes against falling down or lowering after the motor has been switched off, e.g. by means of:

- Mechanical locking of the vertical axle,
- External braking, catching or clamping devices or
- Sufficient balancing of the axle.



The motor holding brake supplied by default or an external motor holding brake driven by the drive controller alone is not suitable for personal protection!



Render the electrical equipment voltage-free using the main switch and protect it from being switched on again until the DC bus circuit is discharged, in the case of:

- Maintenance and repair work
- Cleaning
- long machine shutdowns



Prior to carrying out maintenance work make sure that the power supply has been turned off, locked and the DC bus circuit is discharged.



Be careful during the assembly. During the assembly and also later during operation of the drive, make sure to prevent drill chips, metal dust or assembly parts (screws, nuts, cable sections) from falling into the device.



Also make sure that the external power supply of the controller (24V) is switched off.



The DC bus circuit or the mains supply must always be switched off prior to switching off the 24V controller supply.



Carry out work in the machine area only, if AC and/or DC supplies are switched off. Switched off output stages or controller enablings are no suitable means of locking. In the case of a malfunction the drive may accidentally be put into action.



Initial operation must be carried out with idle motors, to prevent mechanical damages e.g. due to the wrong direction of rotation.



Electronic devices are never fail-safe. It is the user's responsibility, in the case an electrical device fails, to make sure the system is transferred into a secure state.



The servo drive controller and in particular the brake resistor, externally or internally, can assume high temperatures, which may cause serious burns.

Protection against contact with electrical parts

This section only concerns devices and drive components carrying voltages exceeding 50 V. Contact with parts carrying voltages of more than 50 V can be dangerous for people and may cause electrical shock. During operation of electrical devices some parts of these devices will inevitably carry dangerous voltages.



DANGER!

High electrical voltage!

Danger to life, danger due to electrical shock or serious personal injury!

The appropriate DIN, VDE, EN and IEC regulations as well as all national and local safety regulations and rules for the prevention of accidents apply for the assembly and maintenance of the system. The plant engineer or the operator is responsible for compliance with these regulations:



Before switching on the device, install the appropriate covers and protections against accidental contact. Rack-mounted devices must be protected against accidental contact by means of a housing, e.g. a switch cabinet. The regulations VGB4 must be complied with!



Always connect the ground conductor of the electrical equipment and devices securely to the mains supply.



Comply with the minimum copper cross-section for the ground conductor over its entire length as per EN60617!



Prior to the initial operation, even for short measuring or testing purposes, always connect the ground conductor of all electrical devices as per the terminal diagram or connect it to the ground wire. Otherwise the housing may carry high voltages which can cause electrical shock.



Do not touch electrical connections of the components when switched on.



Prior to accessing electrical parts carrying voltages exceeding 50 Volts, disconnect the device from the mains or power supply. Protect it from being switched on again.



For the installation the amount of DC bus voltage must be considered, particularly regarding insulation and protective measures. Ensure proper grounding, wire dimensioning and corresponding short-circuit protection.

2.1.1 Protection against electrical shock by means of protective extra-low voltage (PELV)

All connections and terminals with voltages between 5 and 50 Volts at the servo drive controller are protective extra-low voltage, which are designed safe from contact in correspondence with the following standards:

International: IEC 60364-4-41

European countries within the EU: EN 50178/1998, section 5.2.8.1.



DANGER!

High electrical voltages due to wrong connections!

Danger to life, risk of injury due to electrical shock!

Only devices and electrical components and wires with a protective extra low voltage (PELV) may be connected to connectors and terminals with voltages between 0 to 50 Volts.

Only connect voltages and circuits with protection against dangerous voltages. Such protection may be achieved by means of isolation transformers, safe optocouplers or battery operation.

Protection against dangerous movements

Dangerous movements can be caused by faulty control of connected motors, for different reasons:

- ❖ Improper or faulty wiring or cabling
- ❖ Error in handling of components
- ❖ Error in sensor or transducer
- ❖ Defective or non-EMC-compliant components
- ❖ Error in software in superordinated control system

These errors can occur directly after switching on the device or after an indeterminate time of operation.

The monitors in the drive components for the most part rule out malfunctions in the connected drives. In view of personal protection, particularly the danger of personal injury and/or property damage, this

may not be relied on exclusively. Until the built-in monitors come into effect, faulty drive movements must be taken into account; their magnitude depends on the type of control and on the operating state.

	<p>DANGER!</p> <p>Dangerous movements!</p> <p>Danger to life, risk of injury, serious personal injuries or property damage!</p>
---	--

For the reasons mentioned above, personal protection must be ensured by means of monitoring or superordinated measures on the device. These are installed in accordance with the specific data of the system and a danger and error analysis by the manufacturer. The safety regulations applying to the system are also taken into consideration. Random movements or other malfunctions may be caused by switching the safety installations off, by bypassing them or by not activating them.

Protection against contact with hot parts

	<p>DANGER!</p> <p>Housing surfaces may be hot!</p> <p>Risk of injury! Risk of burning!</p>
---	---



Do not touch housing surfaces in the vicinity of heat sources! Danger of burning!



Before accessing devices let them cool down for 10 minutes after switching them off.



Touching hot parts of the equipment such as the housing, which contain heat sinks and resistors, may cause burns!

2.1.2 Protection during handling and assembly

Handling and assembly of certain parts and components in an unsuitable manner may under adverse conditions cause injuries.

	<p>DANGER!</p> <p>Risk of injury due to improper handling!</p> <p>Personal injury due to pinching, shearing, cutting, crushing!</p>
---	--

The following general safety notes apply:



Comply with the general setup and safety regulations on handling and assembly.



Use suitable assembly and transportation devices.



Prevent incarcerations and contusions by means of suitable protective measures.



Use suitable tools only. If specified, use special tools.



Use lifting devices and tools appropriately.



If necessary, use suitable protective equipment (e.g. goggles, protective footwear, protective gloves).



Do not stand underneath hanging loads.



Remove leaking liquids on the floor immediately to prevent slipping.

Preparation for commissioning

System overview

The DUET_FL servo positioning controller was designed such that it can be mounted directly on the motor. As a result it forms a compact and harmonized unit together with the motor.

Simply connect the power supply and - if applicable - the inputs and outputs or field busses used for your application.

The DUET_FL ServoCommander™ parameterization program can be used to parameterize, commission and analyze the DUET_FL servo positioning controller in a particularly comfortable way.

Connecting the DUET_FL to the control system

Prior to activating the power supply for the DUET_FL servo positioning controller for the first time, you should connect or completely wire the superordinated control / inputs and outputs / field busses and the power supply unit. Please read *chapter Connectors at the DUET_FL 48/10* in the appendix.

For the parametrization of the servo positioning controller, the serial interface of the DUET_FL has to be connected to a free COM port on the notebook / PC.



Please check the wiring and the level of the supply voltages carefully prior to activating the power supply for the first time!

Wiring errors are the most common reason for operating problems.

A wiring error or a too high operating voltage may also damage the device!

3.1 Installation and start of the DUET_FL ServoCommander™

Proceed as follows for the installation from CD-ROM:

1. Put the CD-ROM into the CD-ROM drive of your computer.
2. Start the Windows® Explorer.
3. Select the directory DEUTSCH or ENGLISH on the CD-ROM.
4. Double-click the SETUP.EXE program to start it.
5. Follow the instructions of the installation program.

The installation program creates a new program group called "Motor Power Company". In this program group, you will find the entry "DUET_FL ServoCommander" through which you can start the parametrization program.

Initial parameterization of the controller

Commissioning

Parameter set in the delivery state

The DUET_FL servo positioning controller comes supplied with the **default parameter set**. During commissioning, the default parameter set has to be adapted to the specific application. Otherwise the DUET_FL servo positioning controller has the status "not commissioned".



The default parameter set includes a basic parameterization of the controller for use as a speed controller with setpoint assignment through analog input AIN0. The controller settings and the current limits are set so low that a connected motor of a typical type will not be overloaded or destroyed if the controller is released accidentally.

The manufacturer settings in the **default parameter set** can be restored with the help of the menu **File/Parameter set/Load default parameter set**.



When the **default parameter set** is loaded, the application-specific parameters will be overwritten and the controller status will be set to "not commissioned". This should be taken into consideration when using this function as it requires a new commissioning.

Manual commissioning

If you do not have a parameter set adapted to your motor or application, you should parameterize the following menus in the order stated:

1. Parameters/Application parameters/General configuration...
2. Options/Display units...
3. Options/Input limits...
4. Parameters/Device parameters/Motor data...
Motor identification using the list or the motor data menu
5. Parameters/Device parameters/Angle encoder adjustments...
6. Parameters/Safety parameters...
7. Parameters/Controller parameters/Current controller...

8. Parameters/Controller parameters/Speed controller...
9. Parameters/Controller parameters/Position controller...
10. Parameters/Device parameters/Temperature monitoring...
11. File/Parameter set/Save parameter set (Flash)
Permanent storage of the parameters in the internal flash memory of the servo
12. File/Parameter set/Servo >> File
Storage of the parameter set as a file (option)

Parameterization using the motor database

The DUET_FL DUET_FL ServoCommander™ parametrization program has a motor database in which the most important data for the different motor types can be stored.



Normally, your distributor creates this motor database which then contains data concerning all motors offered by this particular distributor. Please contact your distributor to order this database if it is not included on your installation CD.

This function can be accessed through the menu **Parameters/Device parameters/Motor data/Select new motor**. The program displays a list on which you can find your motor:

Motor data:			
Angle encoder:	Resolver	Real voltage:	30 V
Pole number:	10	Idling speed:	3000 r/min
Offset of angle encoder:	-95,0°	Stator resistance:	0,05 Ohm
Rated current, rms value:	20,33 A	Stator inductance:	0,20 mH
Maximum current, rms value:	32,00 A	Current controller Gain:	1,71
Maximum speed:	4000 r/min	Current controller time const.:	1,80 ms
Torque constant:	0,12 Nm/A	Speed controller Gain:	0,70
Sense of rotation:	right	Speed controller time const.:	16,00 ms

Select your motor if you can find it on the list and confirm your selection by clicking the **Accept values and close dialog** button. Otherwise click the **Quit without changes** button.

Basic parameterization of new motors

Angle encoders

The DUET_FL servo positioning controller supports four angle encoder types.

- ❖ Resolvers / analog Hall sensors with SIN/COS signals (upon request)
- ❖ Stegman SinCos encoders with Hiperface interface
- ❖ Hall encoders (Six Step)
- ❖ Incremental encoders with Hall sensor (only DUET_FL 48/10 FB)

The menu for adjusting the angle encoder parameters can be called up via **Parameters/Device parameters/Angle encoder adjustments**.

Depending on the angle encoder used, the actual menu displayed may differ from the menu shown below as different adjustment options are used.

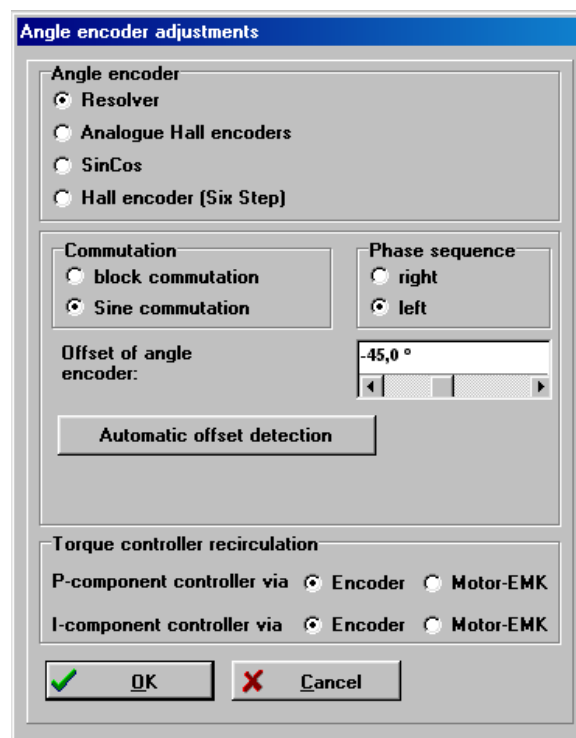

Depending on the angle encoder used, the actual menu may differ from the menu shown below as different setting options are used.

The motor and the **angle encoder** can be identified automatically or manually. If the motor is not installed in system and the shaft can move freely, we recommend using the automatic identification.

The function can be called up in the following menus:

- ❖ **Parameters/Device parameters/Motor data:** "Auto detect" button
- ❖ **Parameters/Device parameters/Angle encoder adjustments:** "Automatic offset detection" button

During the automatic angle encoder identification, the controller is automatically activated for several seconds and the motor is driven with a controlled rotating field. The automatic identification process determines the following parameters:

- ❖ Number of pairs of poles of the motor (not in the case of Six-Step Hall encoders).
- ❖ Angle encoder offset, i.e. the offset between the index mark of the encoder and the magnetic axis of symmetry of the winding of phase 1.
- ❖ Phase sequence of the angle encoder (left, right).
- ❖ Line count (only in the case of SinCos encoders and incremental encoders).

The following conditions have to be fulfilled for an automatic identification:

- ❖ The motor is completely wired.
- ❖ The DC bus voltage (intermediate circuit voltage) is present.
- ❖ The servo positioning controller is error-free.
- ❖ The shaft must move freely.



DANGER !

Prior to starting the motor identification, you have to set the current limits (menu **Parameters/Device parameters/Motor data**) as otherwise the motor may be destroyed!

Click the **Auto detect** button in the angle encoder menu.

The following menu will appear:





Caution! During the adjustment, the shaft automatically starts to move for several seconds.

A successful motor identification is indicated by the following message:



If an error has occurred, the program displays the following message:

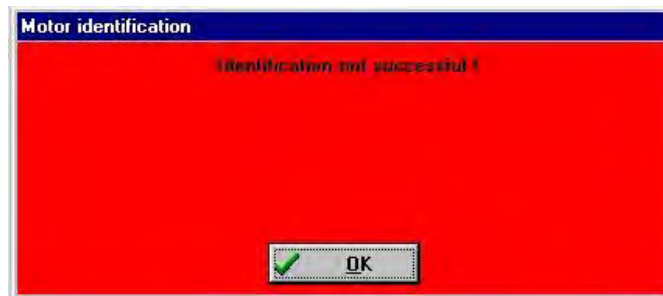

If the automatic determination cannot be performed, the angle encoder data has to be entered manually.

This problem may occur in the following cases:

- If "special motors" with a very high numbers of pairs of poles are used
- If the motor shaft cannot move freely
- If the mass inertia of the motor is very high and if the motor does not settle in the impressed position within the measurement time

The manual determination of the angle encoder data requires good knowledge of synchronous machines and the encoder used. We recommend contacting your local distributor in this case. You have to set the following parameters:

Table 5: Angle encoder parameters

	Resolver	SinCos	Hall encoders (Six Step)	Incremental encoder with Hall sensor
Angle encoder offset	X	X		X
Phase sequence	X	X		X
Offset of second track (Hall encoder)			X	X
Phase sequence of second track			X	X
Line count (number of increments)				X
Index pulse (yes/no)				X



Caution!

Incorrect angle encoder data may lead to uncontrolled movements of the drive. This may damage the motor or the entire system.

In addition to the angle encoder configuration, this menu can also be used to perform basic configurations concerning the control system.

- ❖ Commutation: Block commutation or sine commutation.
- ❖ Speed controller recirculation: Encoder or Motor-EMK (separately for P-component and I-component).

If a motor with analog Hall sensors is used for the commutation, the automatic adjustment of the encoder signals can be started by pressing the button **Automatic encoder optimization**. The DUET_FL determines the optimum offset values and the amplitude values of the SIN and COS track signals and saves them. This reduces the tolerances of the encoder and of the encoder evaluation in the DUET_FL and improves the running behavior.



Caution! During the adjustment, the shaft automatically starts to move for approximately 60 seconds.

Recirculation through the Motor-EMK (electromotive force of the motor) has a positive effect on the running behaviour of the motor if encoders with a poor resolution (e.g. Six-Step Hall encoders) or a low level of accuracy are used. In order to use the recirculation through the Motor-EMK, other electrical parameters of the motor have to be entered in the menu **Options/Device parameters/Motor data** (see *chapter 3.1.1 Motor data*).



Be careful when activating the recirculation through the Motor-EMK!

The actual speed of the motor may deviate significantly from the setpoint if the function and the motor data are not properly configured. The tolerances of the magnets and the windings of the motors in the series also affect the result.

A good compromise between smooth running and a good stationary accuracy can be realized by setting only the P-component of the speed controller to EMK.

3.1.1 Motor data



This menu must be used if the motor could not be identified with the help of the motor list.

This function can be accessed via **Options/Device parameters/Motor data**. The following menu appears. You can enter the maximum current and the rated current of the motor used:

Enter the data shown on the type plate. You can calculate the torque constant as the quotient of rated torque / rated current.



Please note that the values to be entered for the maximum current and the rated current are effective values! If the currents are too high, the motor will be destroyed as the permanent magnets inside the motor will be demagnetised. The current limits stated by the manufacturer must not be exceeded.

The maximum current limits may depend on the clock frequency of the output stage. To parametrize the clock frequency, click the **Power stage** button. See also *chapter Power stage*.

In addition you can enter the number of poles of your motor. There is also an automatic identification function which determines the number of poles and the offset angle of the angle encoder automatically. Simply click the **Auto detect** button.

If the motor is equipped with Six-Step Hall sensors, the number of poles of the motor has to be entered through the parametrization software.



DANGER !

Prior to starting the motor identification, you have to set the current limits (menu **Parameters/Device parameters/Motor data**) as otherwise the motor may be destroyed!

If encoders with a poor resolution (e.g. Six-Step Hall encoders) are used, speed recirculation through the Motor-EMK can have a positive effect on the running behaviour of the motor.

If the speed is determined with the help of the Motor-EMK (electromotive force of the motor), the following formula

$$N_{EMK} = (U_{KL} - (I_q \times R_{mot})) \times \frac{N_{Nenn}}{U_{Nenn}}$$

is used to determine another actual speed value of the motor using the terminal voltage at the motor, the impressed current and the motor parameters.

You can configure the parameters required for calculating the Motor-EMK on the **advanced parameters** tab.

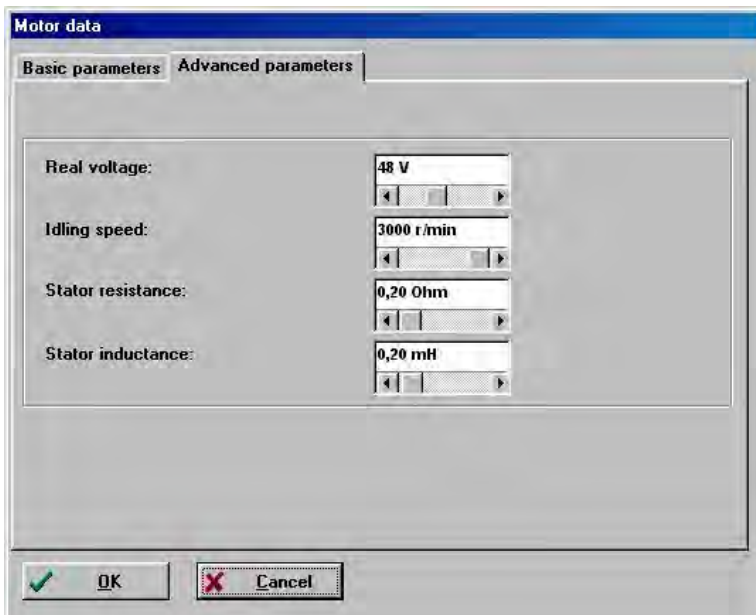

Power stage

This menu (**Parameters/Device parameters/Power stage**) determines the behaviour of the power stage.

You can select a clock frequency of 10 kHz or 20 kHz.

If the clock frequency is low, the motor emits a singing sound. If you want the motor to run as quietly as possible, choose the 20 kHz clock frequency. In addition, the losses in the motor are slightly reduced at a high clock frequency (on the other hand the losses in the DUET_FL servo positioning controller will increase which is why the adjustable maximum current limits are slightly lower). The clock frequency has practically no influence on the control behaviour. The default setting of the clock frequency of the power stage is 10 kHz.



The settings can only be changed if the power stage is switched off. In addition, you have to save the parameter set and reset the device to make the setting effective.

3.1.2 Current controller

The current controller can be configured under **Parameters/Controller parameters/Current controller** in the following menu:

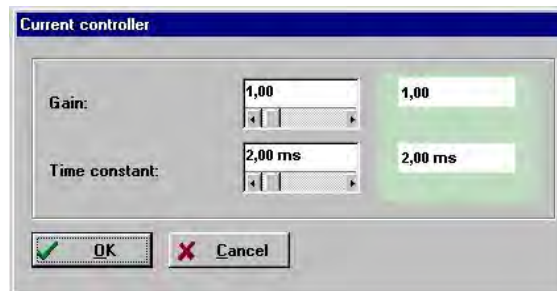

It is essential to adjust the current controller correctly in order to be able to adapt the speed controller to the motor used. The parameters to be configured are the gain and the time constant. Enter the correct parameters. If you are unsure, keep the uncritical values.



Caution!

Incorrect data for the current controller gain and the time constant may lead to oscillations and - due to temporarily excessive currents - also destroy the motor!

The overcurrent detection system of the servo positioning controller may be activated!



DANGER !

Make sure that the maximum currents and the rated currents of the motor have been adjusted correctly prior to optimizing the current controller. If the currents are too high, the motor will be destroyed as the permanent magnets inside the motor will be demagnetised. The current limits stated by the manufacturer must not be exceeded. (See *chapter 3.1.1 Motor data*).

The current controller can be optimized using the oscilloscope function (see *chapter Using the oscilloscope function*). You can display the step response of the current controller by setting the oscilloscope channels to the actual value and to the setpoint value of the active current.

Select the **Torque control** option in the **Commands** menu and enter a current setpoint. Then try to adjust the optimum step response by varying the parameters. The following illustration shows a good step response.

The current should reach the setpoint value within 1 ms and not overshoot by more than 20%. In the case of motors with a high stator inductance, the current may need more time to reach the setpoint value. In any case, the transient process should subside in a well-damped manner and without excessive overshoots.



Figure 1: Current controller step response

DC bus monitoring

In special applications, e.g. when shafts with a high mass are strongly accelerated or decelerated, the intermediate circuit voltage (DC bus voltage) may break down or become too high. If the intermediate circuit voltage becomes too high (overvoltage > 70 V), the DUET_FL servo positioning controller will be shut down. This is a safety function and cannot be parametrized.

Intermediate circuit voltages that are too low can cause an error if this is configured accordingly by the user.

The menu can be activated under **Parameters/Device parameters/DC bus monitoring**.

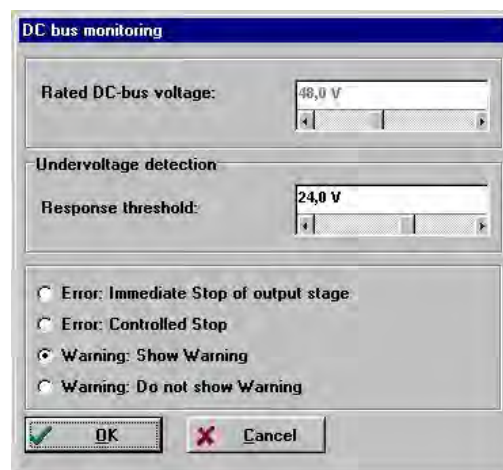

The field **Rated DC-bus voltage** shows the voltage for which the power stage is rated. This value cannot be changed.

In the field **Undervoltage detection**, you can define the response threshold below which the voltage has to fall so that the controller detects an undervoltage. Depending on the power supply unit used, a normal value would be 50%...70% of the rated DC bus voltage.



An undervoltage detection value $< 50\%$ makes not sense as in this case the power supply unit cannot supply the voltage required by the controller in the application. Use a stronger power supply unit instead!

In the error field you can define the response of the servo when it detects an undervoltage. You can also make this setting in the error management menu (see *chapter 6.2 Error management*).

Motor temperature monitoring

If your motor is equipped with a temperature sensor, the sensor can be adjusted in the menu **Parameters/Device parameters/Temperature monitoring**.



In the **Motor temperature** field, you can select whether you are using no motor temperature sensor at all, an analog sensor or a digital sensor.

Select the **digital motor temperature sensor** option, if the motor used is equipped with a normally-closed contact or with a temperature sensor with PTC characteristics. The controller supplies the sensor with a measuring current. The system detects a voltage drop at the sensor and triggers the overtemperature error.

In the case of (partly linear) analog temperature sensors, the temperature threshold has to be set. If the **analog motor temperature sensor** option is selected, you can do this in the **analog motor temperature sensor** field. In addition, you can choose one of the following standard temperature sensor in the scroll box:

- ❖ KTY 81/82-210/220/250
- ❖ KTY 81/82-110/120/150
- ❖ KTY 83-110/120/150
- ❖ KTY 84-130/150

Configuring application parameters

General configuration

The possible options depend on the selected general configuration which can be set in the menu **Parameters/Application parameters/General configuration**. The following menu in which you can select the drive configuration will be displayed:

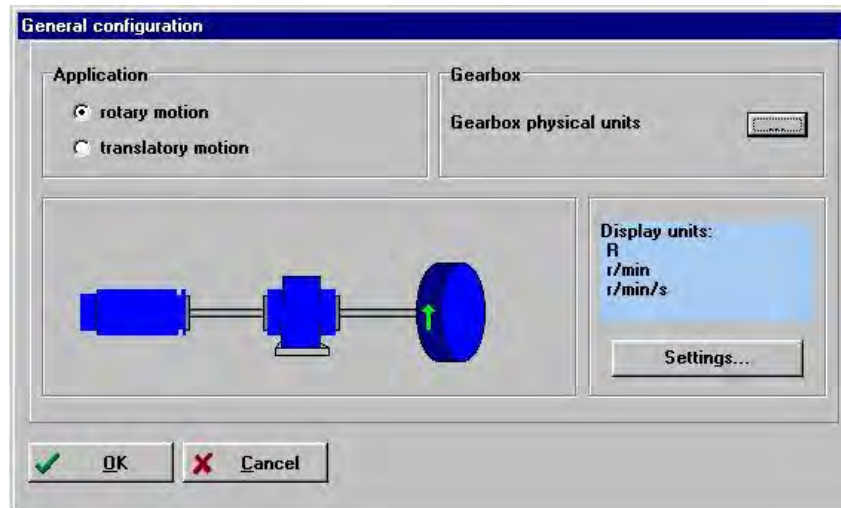

In the **Application** section, you can define whether your application is a **rotary** or a **translatory** application.

If you want to use the unit of the outgoing shaft for the configuration of your application, click the "..." button in the **Gearbox** field or click the **Settings** button. This will lead you to the **Display units** menu described in *chapter Configuring the display units*.

Application examples:

- Rotary with gearbox:
Opening / closing a barrier.
- Translatory with feed constant:
Positioning a carriage to transport goods for further treatment.

Configuring the display units

The menu **Options/Display units** can be used to configure the display units for positions, speeds and accelerations. These unit will be used only for the display in the parametrization program. The parametrization program uses so-called communication objects to communicate with the controller. These communication objects have a fixed physical basic unit. These basic units are used for every access via the RS232 interface.

The user can select display units for the following physical quantities:

- ❖ Position / Revolutions
- ❖ Speeds
- ❖ Accelerations
- ❖ Torques (in Nm or A)



The display units are configured regardless of any setpoint assignment via field bus. Thus, the configuration of the display units does not affect the factor group or the notation and dimension indices in field-bus-specific protocols such as the CANopen factor group!

Table 6: Display mode

Selection	Units
Standard values For linear axes: Positions in distance units, speeds in [distance units]/s, accelerations in [distance units]/s ² . For rotary drives: Positions in revolutions, degree or radian, different speed and acceleration units.	User-defined
Examples: <ul style="list-style-type: none"> ❖ For linear axes and non-metric distance, speed and acceleration units (e.g. inch, inch/min). ❖ For rotary drives with special 	Direct input

Selection	Units
distance, speed and acceleration units.	
Free configuration of the distance, speed and acceleration units.	
For experienced users only!	

The **Decimal places** tab can be used to adapt the resolution of the quantity to be represented to the actual conditions.

The **Direct input** tab can be used to configure the DUET_FL SerovCommander™ such that other display units than the ones offered can be used.



Further information can be found in *chapter Extended options in the "Display units" menu*.



Caution! For experienced users only!

On the **Direct input** tab, you can directly write to the factor group if you have select the direct input option.

When you quit the menu, the program displays the following question:



The input limits are automatically adapted to the selected physical units. If you want to, you can check this. Click the **Yes** button to do so.

3.2 Defining input limits

Options/Input limits opens the following menu:

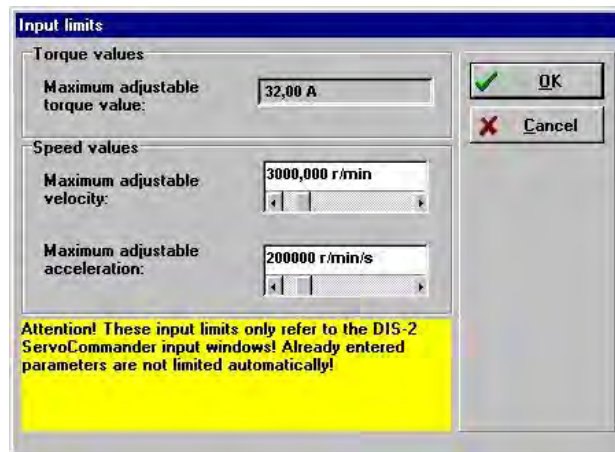

Enter the maximum speeds and accelerations you are expecting for your application. The program uses this information to limit the input fields.



The input limits can be changed later. They affect **only** the input fields of the parametrization program!

Speeds and accelerations will **not** be limited physically in the drive! The quantities in the drives can be limited in the **Safety parameters** menu described in *chapter 3.3 Selecting safety parameters*.

3.3 Selecting safety parameters

To protect the mechanical system from overload, the speed and acceleration values as well as the movement range have to be limited to "safe" values for many applications. The setpoint values can be limited in the menu **Parameters/Safety parameters**.

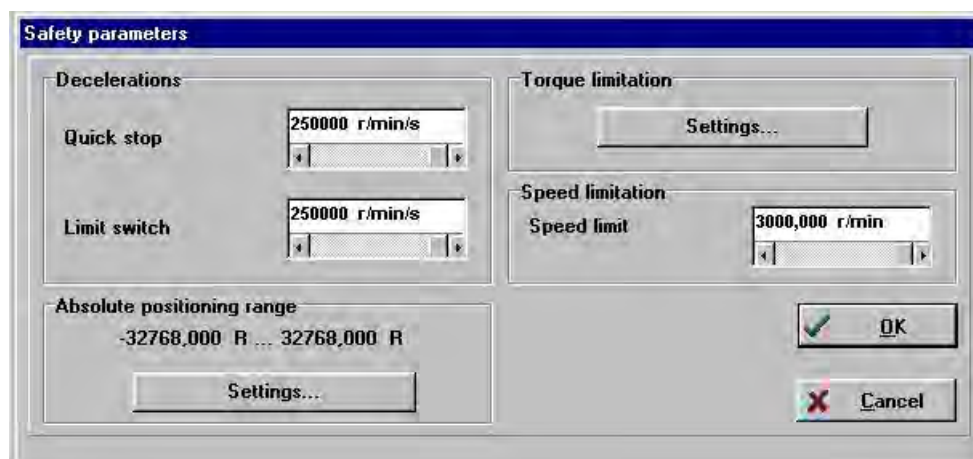

You can configure the following safety parameters in this window:

- ❖ Decelerations:
 - Quick stop deceleration:
 - This deceleration will be used when the controller is no longer enabled or in the event of an error (if possible).

- Limit switch deceleration:
This deceleration will be used when the drive hits a limit switch.
- Decelerations #STOP input:
This deceleration is used if the digital input DIN1 is set to low in the jogging & teaching mode.
- ❖ Maximum stop delay:
If the drive could not be brought to standstill in a controlled manner after the controller was disabled (e.g. due to an incorrect parametrization), the output stage will be switched off after this delay and the motor will coast down if it had not already been decelerated to zero.
- ❖ Speed limitation:
The speed setpoint will be limited to the value set in this field.
- ❖ Torque limitation:
The **Settings** button opens the **Motor data** menu (see *chapter 3.1.1 Motor data*). There you can define a torque limitation in Amperes by setting the limit **Maximum current in A, rms value**.
- ❖ Absolute positioning range:
The **Settings** button opens the **Settings position sets / Course program** menu (see *chapter Global positioning settings*). There you can define a maximum positioning range (SW limit switch functionality).



Depending on the settings of the control circuits for current, speed and position, the parameters set may be temporarily exceeded due to "overshoots" in the control system. This has to be taken into consideration when setting the system up. It might be necessary to optimize the controller under real operating conditions.

Configuring the controller enable logic

To enable the power stage with a control system in the DUET_FL servo positioning controller, the controller enable logic has to be configured. The controller enable logic defines the conditions to be fulfilled so that the controller can be enabled and the motor can be supplied with power.

You can find the menu for configuring the controller enable logic under **Parameters/Device parameters/Controller enable logic**.

This menu can also be called up via the **Commands** window:

To do so, click the "..." button in the **Controller enable** field.

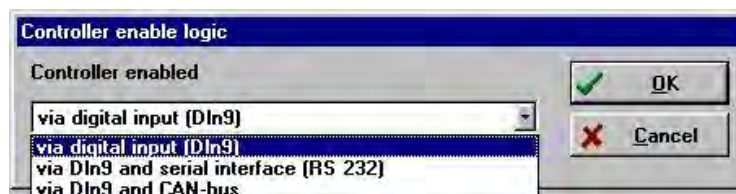

You can select the following options from a so-called combo box:

- ❖ Via digital input (DIN9):
The controller will be enabled exclusively via the digital input DIN9
- ❖ Via DIN9 and serial interface (RS 232):
To enable the controller, DIN9 must be set and a corresponding serial command must be issued. This can be ensured, for example, by selecting the **Controller enable** check box in the **Commands** window.
- ❖ Via DIN9 and CAN-bus:
To enable the controller, DIN9 must be set and an enabling command must be issued via the CAN bus.

Configuring the limit switch polarity

The servo positioning controller supports limit switches with normally-closed contacts and normally-open contacts.

Adjust your drive such that no limit switch is active when the drive is located in the permissible positioning range. Make sure that no LED is active in the menu shown below. You can set this by selecting either the **NC contact** option (DIN7, DIN8 = +24V → setpoint enabled) or the **NO contact** option (DIN7, DIN8 = +24 V → setpoint blocked).

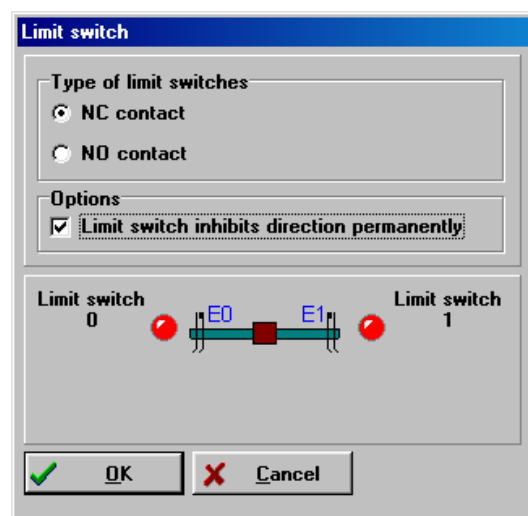

The little illustration in the middle shows a red arrow when the drive moves in the direction of one of the limit switches. Thus you can directly see how the limit switches are assigned to the direction of movement and change the wiring of the limit switches if necessary.



As long as a limit switch is active, the setpoint in the corresponding direction of rotation is blocked. In applications where the drive can overrun the limit switches or in applications with bouncing limit switches, the option "**Limit switch inhibits direction permanently**" can be used. If the option is activated, the direction of rotation in which a limit switch has been set off, remains blocked when the limit switch has been left. In this case, the drive can leave the limit switch, but it is not possible to move

in the direction of the limit switch again. The blocked direction of rotation remains blocked until the controller is disabled.

Setting the direction of rotation

The option “**Reversal of rotation direction**” can be activated in the lower area of the **Commands** window. This option can be used to assign a certain angle counting direction or the desired sign of the speed and current/torque to a direction of movement.

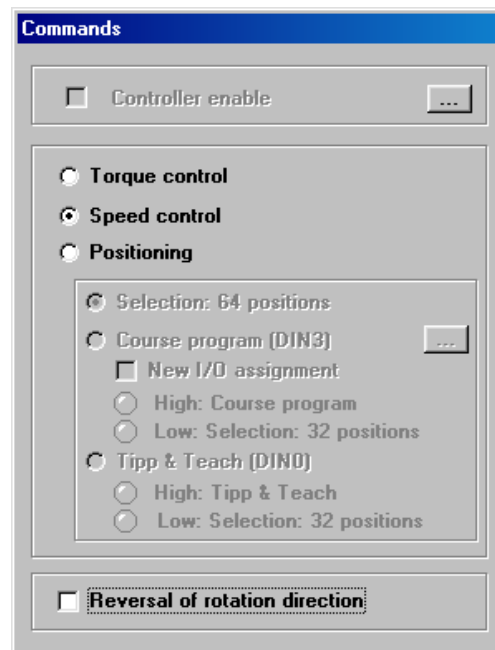

DANGER !

If this option is activated, the drive moves in the opposite direction with the same settings.

Making the system ready for operation, enabling the power stage

The aim of this chapter is to let the motor rotate at a constant speed. Then the other control functions, such as the speed controller and the position controller can be optimized. The setpoints are assigned via the analog inputs. The controller has to be enabled via the digital "controller enable" input.



DANGER !

Do not work through this chapter until you have completely followed the instructions given in the other parts of *chapter* and particularly the instructions concerning the configuration of the current limits, the current controller and the safety parameters.

Incorrect basic settings may destroy the servo positioning controller / motor and the mechanical drive!

It has turned out to be useful to set the current limits and particularly the maximum current of the controller to "small" values (e.g. to half of the rated current), as this prevents strain on all components including the mechanical system if other drive parameters are improperly configured.

To let the motor rotate in a speed-controlled manner, you have to configure the following points:

- 1) Activate the speed control mode (see *chapter Speed-controlled mode*).
- 2) Set the controller enable logic to "via digital input" (see *chapter Configuring the controller enable logic*).
- 3) Activate the speed control via the analog input 0 (see *chapter 4.2 Setpoint assignment through setpoint selectors*) and parametrize the desired analog speed range (*chapter Analog inputs AIN0 and AIN1*).

If you cannot use the analog input, you can also assign the setpoints via the serial interface (see *chapter 4.2 Setpoint assignment through setpoint selectors*).

- 4) Before you test the controller enabling process, you should save the parameters in the drive. To do so, click the button shown here. You can find the button on the upper menu bar of the main window.

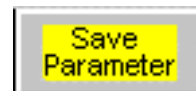

- 5) Now briefly activate the controller enabling system.

After the control system has been enabled, the shaft has to start rotating. If the motor does not show this behaviour, there is either an error or the DUET_FL servo positioning controller has been parameterized incorrectly. The following table shows typical errors and how you can eliminate them:

Table 7: Error elimination: Speed control

Error	Remedy
The motor develops a holding torque. It "blocks" in different positions.	The number of pairs of poles and/or the phase sequence is incorrect. Set the correct number of pairs of poles and/or interchange the motor phases. Perform another automatic identification. (See <i>chapter 3.1.1 Motor data</i>)
The motor shaft oscillates or runs unevenly.	The parametrization of the angle encoder offset (see <i>chapter Speed-controlled mode</i>) and/or the controller parameters are incorrect. Perform another automatic identification. (See <i>chapter Angle encoders</i>)
The shaft does not rotate.	No intermediate circuit voltage (DC bus voltage).
	The limit switches are active.
The shaft does not rotate. The actual value window still shows a speed setpoint of "0".	The speed setpoint has not been configured correctly. Further information can be found in <i>chapter 4.2 Setpoint assignment through setpoint selectors</i> .



When you are connecting the motor phases, please have mind that the servo motor manufacturers configure the phase sequences differently. It might be necessary to interchange the phases U and W.

4 Current and speed control

Function overview

The current and speed control system is a cascade control structure with an internal current control circuit and a superimposed speed control circuit. These controllers are PI controllers. The setpoint selectors are used to transfer setpoints from various different sources to the corresponding controllers (see *chapter 4.2 Setpoint assignment through setpoint selectors*).

The basic structure is shown in the block diagram on the next page.

In the case of a rotor-oriented control, two phase currents and the rotor position are measured. At first, the currents are transformed into an imaginary part and a real part with the help of a Clark transformation. Then they are transformed back into the rotor coordinates using a Park transformation. This allows the rotor currents to be controlled to corresponding rotor voltages using PI-controllers and to transform them back into the stator system. The driver signal generation uses a symmetrical pulse width modulation for the power stage in sine commutation with the third harmonic.

An integrator monitors the current²-time-integral of the controller. If a maximum value (maximum current for 1s) is exceeded, a warning will be issued and the current will be limited to the rated current.

The main advantages of the rotor-oriented current control have already been summarized in *chapter features*.

In torque-controlled mode, a current setpoint **i_set** is predefined for the active current controller. In this operating mode, only the current controller in the servo positioning controller is active. As the torque generated on the motor shaft is approximately proportional to the active current in the motor, one can justifiably talk about torque control.



The accuracy of the torque control depends mainly on the motor and the sensor system used to measure the rotor position.

With a good synchronous machine, a high-resolution rotary encoder (SINCOS encoder) and good controller adjustment, the DUET_FL can reach a torque ripple in the range of 1% to 3% referred to the maximum current or the associated maximum torque of the motor.

In speed-controlled mode, a certain speed setpoint is assigned. The DUET_FL servo positioning controller determines the current actual speed **n_actual** through the encoder evaluation. To make sure that the speed setpoint is complied with, the current setpoint **i_set** is determined.

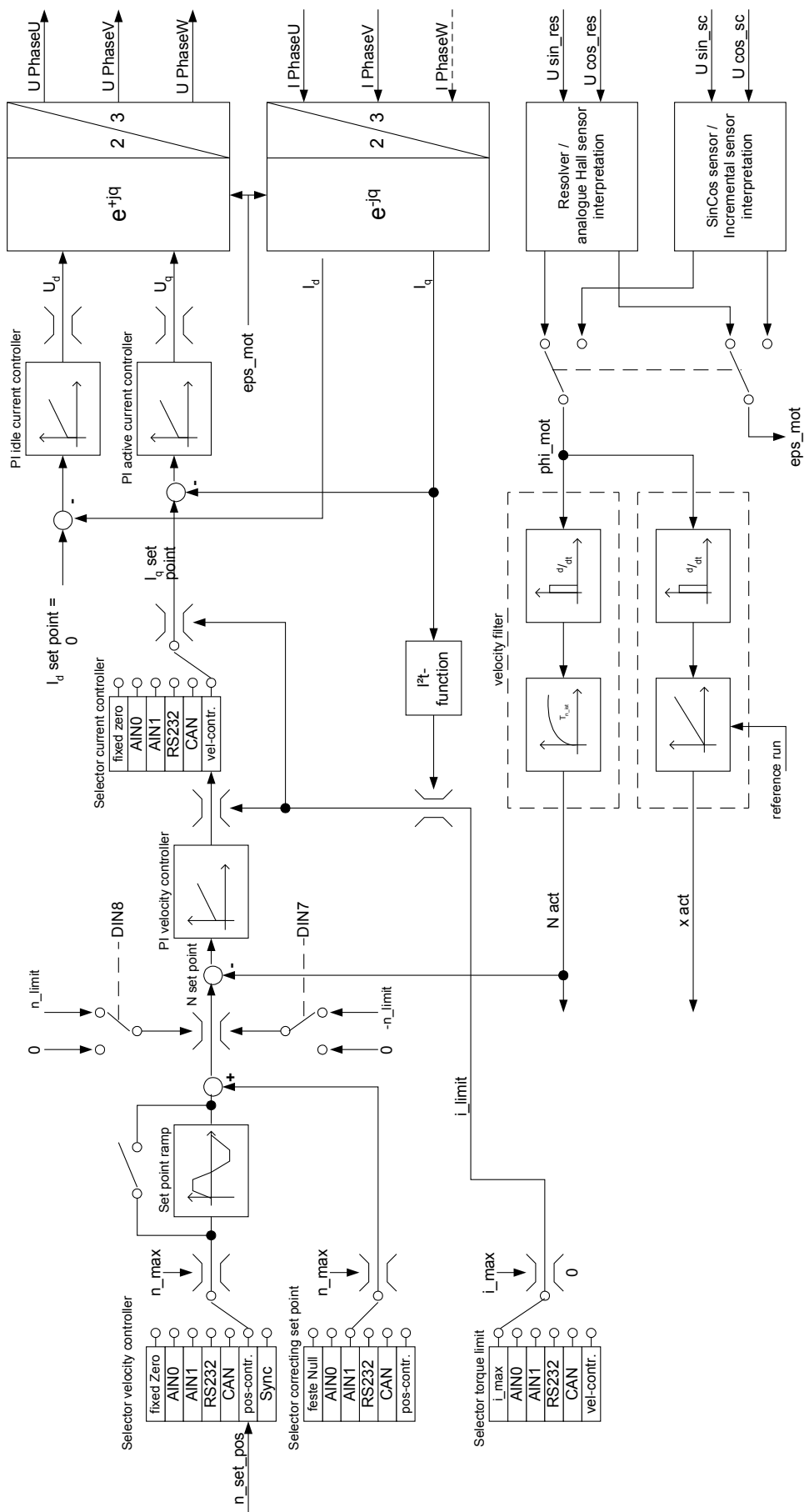

Figure 2: Speed controller

Speed-controlled mode

To activate the speed-controlled mode, the Commands windows has to be configured as follows:



For information on how to configure the setpoints in this operating mode see *chapter 4.2 Setpoint assignment through setpoint selectors*.

4.1.1 Optimizing the speed controller

To optimize the speed controller for your application, you can open the menu for configuring the controller parameters under **Parameters/Controller parameters/Speed controller**.

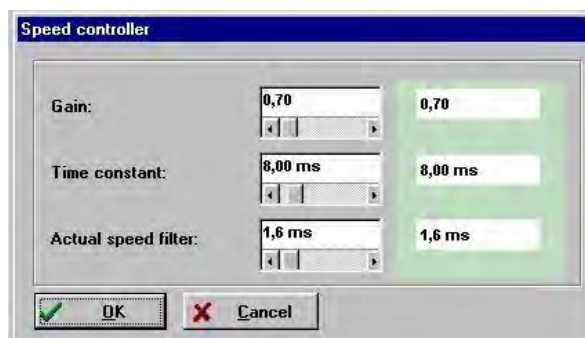

In this menu, you can configure the **Gain** and the **Time constant** for the PI controller.

To optimize the control response, the measured actual speed value has to be smoothed. This is done using an **Actual speed filter**. The effective filter time constant can be parametrized:



If the time constant of the actual speed value filter is too high, the dynamic response deteriorates as disturbances are detected with a delay. In certain unfavourable cases, a too high time constant can have a negative effect on the stability of the speed control circuit. The additional run time may lead to oscillations.

If the time constant is too low and gain factors are high, you will hear current noise in the speed controller and notice a slight unsteadiness of the shaft. In addition the motor will heat up more strongly.

Set the time constant as low as possible for reasons of stability. The downward limit is the noise. Typical values for the actual speed filter are 0.6 ms to 2.0 ms.

The speed controller has to be adjusted such that there is only one overshoot of the actual speed value. The overshoot should be about 15% higher than the set speed. The falling edge of the overshoot, however, should not be below the speed setpoint or just slightly below it and then reach the

speed setpoint. This setting applies to most motors which can be operated using the servo positioning controller. If a harder control response is required, the gain of the speed controller can be increased further. The gain limit is due to the fact that the drive tends to oscillate at high speed levels or when the shaft is excited. The gain that can be reached in the speed control circuit depends on the load conditions at the motor shaft. This is why you have to check the speed controller setting again when the drive is installed.



If you parameterize the speed controller while the motor shaft runs at no load, you have to increase the speed controller gain after you have installed the drive.

Optimization strategies The behaviour of the speed controller can be observed best by recording its response to a speed step. Activate the speed control mode and deactivate any ramp functionality active in the setpoint selector menu. You can realize a speed step, for example, by assigning setpoint steps through the RS232 interface. Or you can use the setpoint assignment via an analog input which you have to short-circuit in order to realize a step.

The reaction of the speed controller can be observed using the oscilloscope function (see *chapter Using the oscilloscope function*). You can display the step response of the speed controller by setting the oscilloscope channels to the actual speed value (rough) and to the speed setpoint value.



Make sure that you do not change the numbers for the gain factor and the time constant in too large steps. Use small changes.

You should start with a relatively long integration time in the range of 8 ms to 10 ms and then increase the gain progressively. Only after you have felt your way towards the right setting by increasing the gain should you reduce the integration time step by step.

After the numbers have been changed, there may be two different situations:

- ❖ If the setting is too hard, the speed controller will become unstable.
- ❖ If the setting is too soft, the drive will not be rigid enough which will lead to following errors.



The speed controller parameters are not independent of each other. A measurement curve which differs from trial to trial can have various reasons. This is why you should change only one parameter at a time: Either the gain factor or the time constant.

To adjust the speed controller, increase the gain until oscillation starts and then decrease the gain in small steps until oscillation ceases. Then decrease the time constant until oscillation starts and decrease it again in small steps until the controller is stable and rigid enough at a setpoint = 0.

Case 1: Speed controller too soft

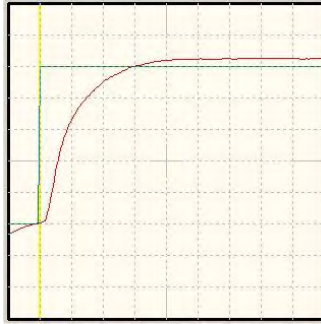

Figure 3: Speed controller too soft

Remedy: Increase the gain factor by 2 to 3 tenths /
Then decrease the time constant by 1 to 2 ms

Case 2: Speed controller too hard

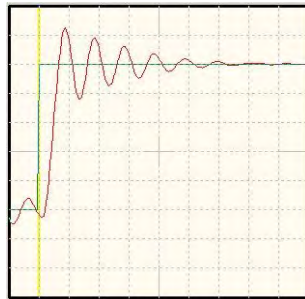

Figure 4: Speed controller too hard

Remedy: Decrease the gain factor by 2 to 3 tenths /
Increase the time constant by 1 to 2 ms

Case 3: Speed controller set correctly

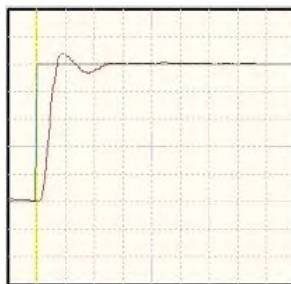

Figure 5: Speed controller set correctly

Torque-controlled mode

To activate the torque-controlled mode, the Commands windows has to be configured accordingly.



The torque setpoint can be specified in **A** or **Nm**. This can be done with the help of the menu item **Options/Display units**. The associated menus will then automatically adopt the selected unit.

If you want to use the unit Nm for the torque, you have to make the **torque constant** known, i.e. the conversion factor between the current and the torque. The torque constant has to be entered into the menu **Parameters/Device parameters/Motor data** and can be calculated using the information stated on the type plate of the motor. Divide the rated torque by the rated current.



A torque constant of **0 Nm/A** is not permissible if "torques in Nm" has been selected.

4.2 Setpoint assignment through setpoint selectors

The DUET_FL servo positioning controller allows you to assign the setpoint through a setpoint management system in the torque control and speed control mode. You can find the corresponding menu under **Operating mode/Setpoint-Selection**. The following setpoint sources can be selected:

- ❖ 2 analog inputs:
 - AIN 0 and AIN 1 (parameterization see *chapter Analog inputs AIN0 and AIN1*)
- ❖ Fixed value RS232
- ❖ Fixed value CAN
- ❖ Position controller (in speed control mode)
- ❖ Speed controller (in torque control mode)



If no setpoint source is active, the setpoint is zero.

The setpoint management system manages your settings separately for the individual operating modes. This means that when you change the operating mode, the setpoint selector will be automatically set to the values defined last by you in the respective operating mode.

Speed-controlled mode

The setpoint management system includes a ramp generator. Any of the above-mentioned setpoint sources can be selected under **Selector: Speed setpoint** and run through the ramp generator. You can also select another addition setpoint source, **Selector: Correcting setpoint**. This other setpoint source, however, will not be fed through the ramp generator. The total setpoint is a summation of the two values. The acceleration and deceleration time of the ramp can be parametrized depending on the direction.

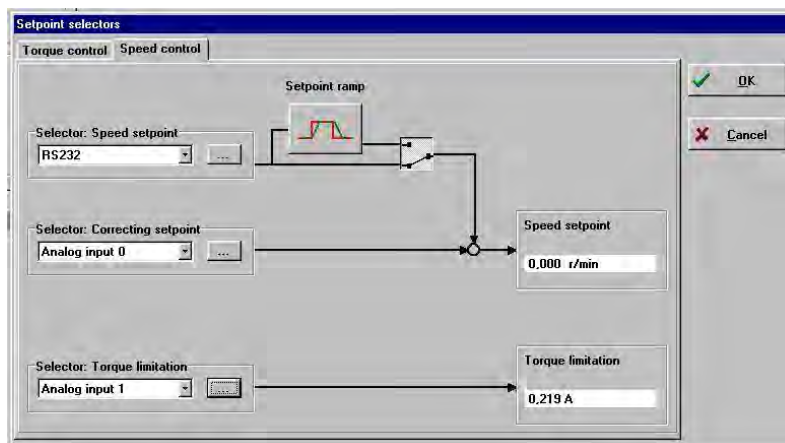



In the speed setpoint selector menu shown above, you can also activate the torque limitation. This is symmetrically possible and the limitation source can be selected as desired.

Torque-controlled mode

If you select the **Torque control** tab, you can select any of the above-mentioned setpoint sources under **Selector: Torque setpoint**. However, the ramp generator and the correcting setpoint are not available in torque-controlled mode.

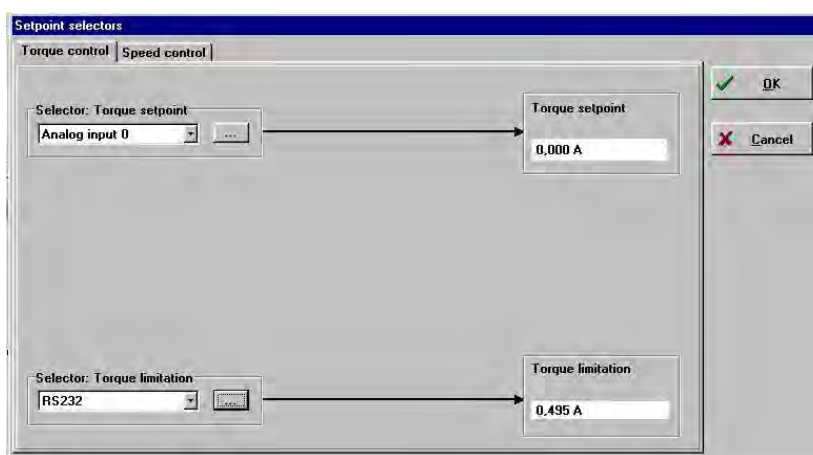
You can also activate the torque limitation.



 If an analog input is activated as the setpoint source but the menu does not show a line towards the setpoint, the digital inputs may be activated. (See *chapter Configuring the digital inputs*)

4.2.1 Setpoint assignment through RS232

If you have configured one of the setpoint sources such that the setpoint is assigned through RS232, you can configure this under **Operating mode/Setpoint selection RS232**. You can also open the menu by clicking the "..." button next to the setpoint selector.

The following window will appear:

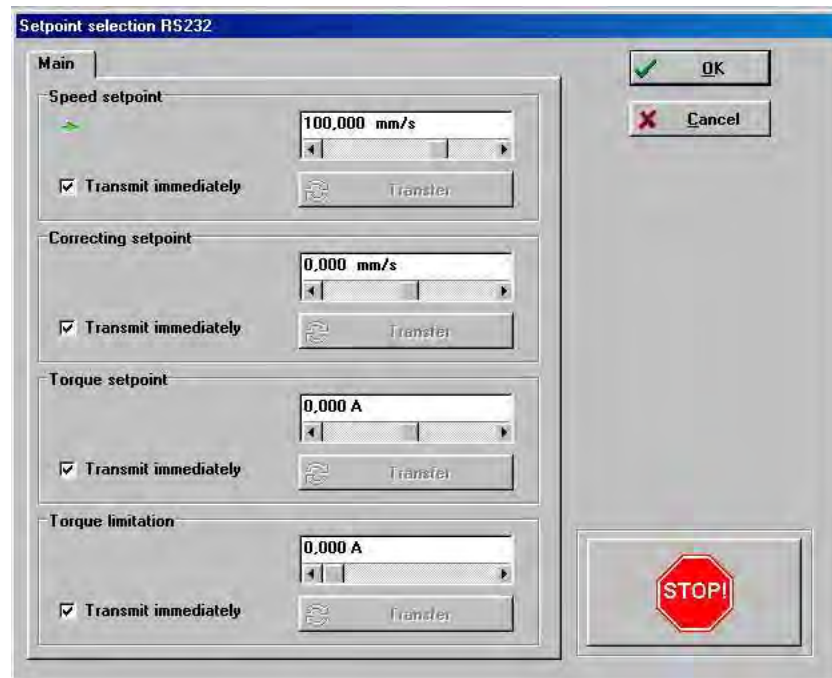

Activated RS232 sources are marked by a green arrow.

Here you can enter numerical values for the setpoints and limitations. Click the red **STOP** button if you want to cancel false inputs immediately. The setpoint will be set to **0** and transmitted immediately.

If you do not want to transmit the setpoint immediately, deselect the **Transmit immediately** check box. Then you have to click the **Transfer** button to transmit new setpoints.

Setpoint ramp

The DUET_FL servo positioning controller can process speed steps in numerous different ways. It can transfer the step directly to the speed controller without filtering it, or it can calculate a function to smooth the setpoints of the **Selector: Speed setpoint** using a ramp with an adjustable gradient.

The ramp generator can be activated and deactivated using this button



The menu for configuring the ramp can be activated in the setpoint selector menu using the icon



or under **Operating mode/Ramps**.

The following window will be displayed:

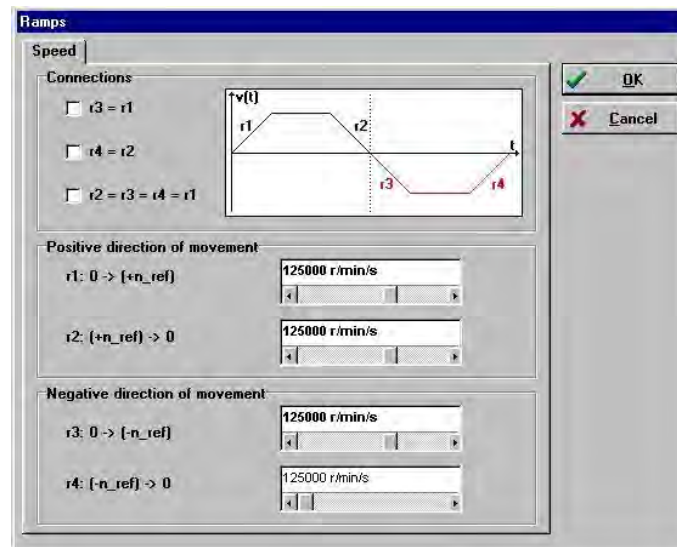

The ramps can be configured separately for right-handed and left-handed rotation as well as for rising and falling speeds.

If the ramp accelerations are partly identical, you can reduce your input workload by selecting the check boxes [r3 = r1], [r4 = r2] or [r2 = r3 = r4 = r1].



The ramp generator should be used if the controller is in speed-controlled mode and no position control is active (also not in an external control). Configure the ramps such that the drive will not be controlled into the current limitation during acceleration under realistic load conditions.

When the setpoint ramp is configured correctly, overshoots of the speed controller when running into the speed setpoint can be reduced considerably compared to the operation without a setpoint ramp.

The setpoint ramp must not be activated in the case of application with a position control system (either internal or through the external control) as from a control point of view the ramp operates like a PT_1 filter and decreases the stability in the control circuit.

Torque limitation

As mentioned before, a torque limitation can be parametrized in the speed control operating mode. In this case, the selected setpoint source specifies a certain maximum torque. This maximum torque then limits the setpoint symmetrically for the current controller or the torque controller.

Please keep in mind that the current setpoint is also limited by the values set in the motor data menu for the rated current and the maximum current. The current setpoint is limited to the lowest torque limit.



Application requiring torque control in a quadrant, i.e. the adjustment of the torque from zero to maximum in one direction of rotation, can be realized well in most cases in the speed control mode with torque limitation:

- The torque setpoint is assigned through the torque limitation
- The speed setpoint is assigned through a separate setpoint. This prevents the drives from "spinning" under no-load conditions and the speed will be limited to non-dangerous values.

5 Positioning mode



You can skip this chapter if your drive is used only in speed or torque mode.

5.1 Function overview

In the positioning mode, a positioning control is superimposed on the speed control. In the positioning mode, a specified position is set. The motor has to move to this position automatically, i.e. without any interaction with an external control system. In this operating mode, the controller cascade in the DUET_FL controller will be extended as shown in Figure 6.

- The position controller is a proportional controller (short: P-controller). The current position is determined using the information of the internal encoder evaluation. The position deviation is processed in the position controller and passed on to the speed controller as a speed setpoint.
- A trajectory generator computes the motion profile needed to reach the target based on the current position and on the current speed. It provides the position setpoint for the position controller and a pilot speed for the speed controller to improve the control dynamics in the event of rapid positioning processes.
- The positioning control provides numerous messages required for the external control system, e.g. a target-reached messages and a following error message.

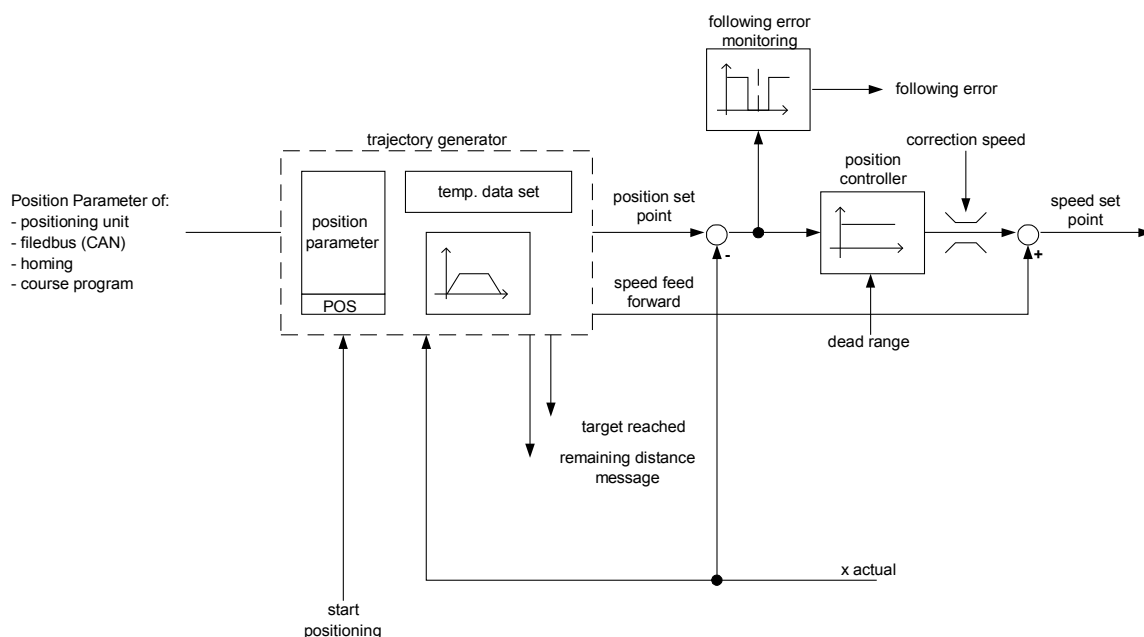

Figure 6: Positioning control block diagram



In contrast to many competition products, the DUET_FL controller recalculates the entire movement process in every control cycle. This means that positioning processes can be changed or aborted at any time even during the movement. This concept is supported by the high level of performance of the Motion-Control-DSP inside the DUET_FL controller.

The high-performance positioning control system in the DUET_FL controller has numerous parameters and position data sets. Up to 64 position sets can be stored in a non-volatile manner in the DUET_FL and approached with the help of the trajectory generator.

Each of the 64 position sets includes a separate target position (destination). The other parameters of the 64 position sets are divided into 4 groups.

The following parameters can be set for each of the 4 position groups:

- ❖ Accelerations
- ❖ Running speed
- ❖ Selection of the type of acceleration:
Jerk-limited speed profile or time-optimal (constant acceleration)
- ❖ Relative or absolute positioning
- ❖ Wait for end of running positioning run or reject
- ❖ Start delay

As an alternative, the DUET_FL also allows to save all the parameter of a position set individually for each position set. This means a higher level of flexibility in the various motion profiles. As a result, the maximum number of available position sets is reduced to 16.

The maximum number of available position sets, i.e. 16 or 64, can be set through the DUET_FL ServoCommander™ (see *chapter Global positioning settings*).

In addition, there are position data sets for positioning processes using the CAN bus (DSP402) and position sets for homing.

The positioning control thus supports point-to-point movements with the final speed zero (standstill at target point). Positioning process can be aborted during the movement and the next position can be directly approached.

The groups and positions are selected through the digital inputs (see *chapter Approaching destinations*). The RS232 interface can be used alternatively for the selection.

The position data sets for homing or for positioning processes through CAN (DS402) are fed directly to the trajectory generator.

Activating the operating mode

To activate the homing or positioning mode, the Commands windows has to be configured as follows:

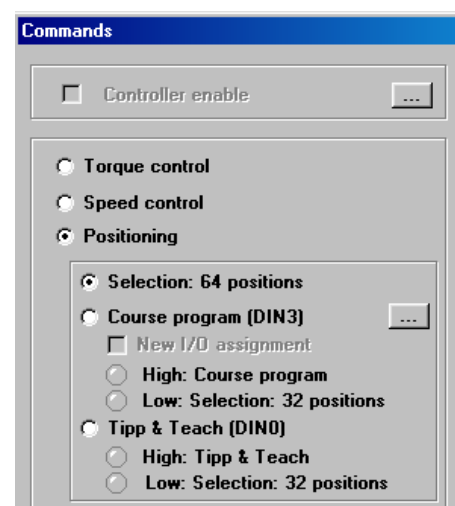

**DANGER !**

Do not activate the positioning mode unless you have adjusted the motor parameters and the current and speed controller.

Incorrect basic settings may destroy the servo positioning controller, the motor and the mechanical drive!

5.2 Configuring and optimizing the position controller

In positioning mode, a superordinated position controller is active in addition to the speed control. This position controller processes the deviation of the actual position from the set position and converts it into the corresponding setpoints for the speed controller. The position controller generates a correction speed on the basis of the difference between the set position and the actual position and transfers this speed value as a setpoint to the speed controller.

The position controller is used in conjunction with the positioning control system. It is a P-controller with parameterizable input and output limitations.

You can open the window for parameterizing the position controller under **Parameters/Controller parameters/Position controller**.

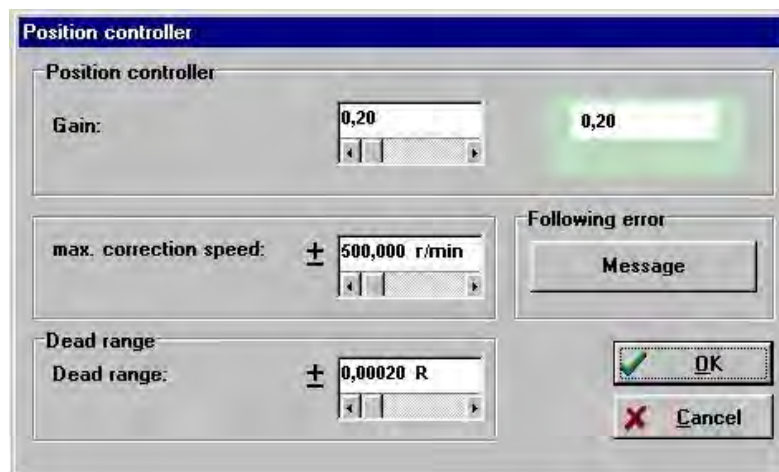

Enter the following values:

- ❖ **Gain:**
- ❖ **Max. correction speed:**
In this field you can define the speed to be added to the running speed in the event of a deviation between the position setpoint and the actual position. At the beginning, it should be set to about +/- 500 rpm.
- ❖ **Dead range:**
Here you can state an admissible distance between the setpoint value and the actual value within which the position controller stays inactive. The dead range can suppress oscillations which may occur when encoders with a low resolution are used, e.g. in block-commutated drives with position recirculation exclusively through the Hall sensor integrated in the motor. The dead range should be set to zero to reach the highest possible position accuracy.
- ❖ **Following error:**
Parameterization of a following error and a response delay. When the deviation between the setpoint and the actual value is greater than the configured limit, a message or an error will be issued. The reaction has to be set accordingly in the fault management system.

Position controller optimization



To optimize the position controller it is essential that the current controller and the speed controller have been adjusted correctly. (See the preceding chapters)



Please make sure that the motor shaft can rotate freely and that the drive cannot be damaged.

The following steps have to be performed for the optimization:

1. Activate the position controller and set the gain to 0.5.
2. Open the menu for parametrizing the position data sets (see *chapter position sets*) and enter the following values for destination 0 and destination 1:
 - ❖ Destination 0: 10 R / Destination1: -10 R
 - ❖ Speed: (half rated speed)
 - ❖ Acceleration: (maximum value)
 - ❖ Deceleration: (maximum value)
3. Start the oscilloscope (see the appendix, *chapter Using the oscilloscope function*) by activating the menu item **Display/Oscilloscope** and set the following values:
 - ❖ Channel 1: Actual speed value; scaling = 1000 rpm / div; -2 div
 - ❖ Channel 2: Rotor position; scaling = 50 ° / div; offset 1 div
 - ❖ Time base: 100 ms / div; delay = -200 ms
 - ❖ Trigger: Source = actual speed value; level = half running speed; mode = normal, falling edge
4. Enable the power stage. Start the positioning run alternately with destination 0 and destination 1 with the help of the **Go to destination** menu (see *chapter Approaching destinations*). The motor now reverses within the specified limits.

Optimization: Evaluate the speed and the rotor position during stopping. If the transient process of the position takes too long, increase the gain. If the speed starts to oscillate during stopping, the gain has to be decreased.

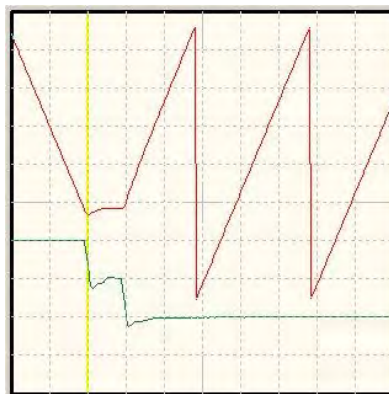

Figure 7: Speed controller optimization

Please note that the overshoots are due to missing acceleration and deceleration time values.

Global positioning settings

Via **Parameters/Positioning/Settings position sets/Course program** you can open the **Settings position sets / course program** menu where you can define the positioning range as a global setting for all positioning runs.

In the case of absolute positioning runs, the new destination is checked to see whether it lies between the limits for the absolute positioning range. The **minimum** and **maximum** parameters in the field **Positioning range** indicate the absolute position limits for the position setpoint and the actual position value. The positioning range always refers to the zero position of the drive.

The **Homing run** button leads you to the homing menu (see *chapter Homing*).

The **Destination parameters** button leads you to the menu for parametrizing the destinations (see *chapter position sets*).

In the lower section of the window, some settings for the course program can be made. In case the **Course program active** is select, the check box from the course program will be enabled in the positioning mode. The button leads to the course program menu (see *chapter Course program*). In addition you can define two start lines for the course program.

The option **16 / 64 position sets** can be used to define the desired number of target positions (destinations):

- If the option **64 position sets** is active, you can parametrize 64 independent target positions. All the other motion profile parameters (accelerations, start delays, options, ...), however, have to be set in groups. There are four groups with the position numbers (0..15), (16..31), (32..47), and (48..63).
- If the option **16 position sets** is active, you can parametrize 16 independent target positions. The motion profile parameters (accelerations, start delays, options, ...) can be set individually for each position.



In order to switch from the "64 positions" mode to the "16 positions" mode or vice versa, the DUET_FL has to reorganize the internal data structures for the positioning process. During this reorganization, settings already made for the targets are lost. The position data sets are reset to default values.

This means that you have to re-parameterize all the targets after you have changed the operating mode.

Parametrizing position sets

In the DUET_FL servo positioning controller 16 or 64 positions sets can be parametrized. The parametrizing accomplished in the menu **Parameters/Positioning/Destination parameters**.

Click the **GO!** to start a positioning run with the destination set currently displayed.

Click the **Positioning settings** button if you want to change general positioning settings (e.g. position limits) (see *chapter Global positioning settings*).

Tab: Settings

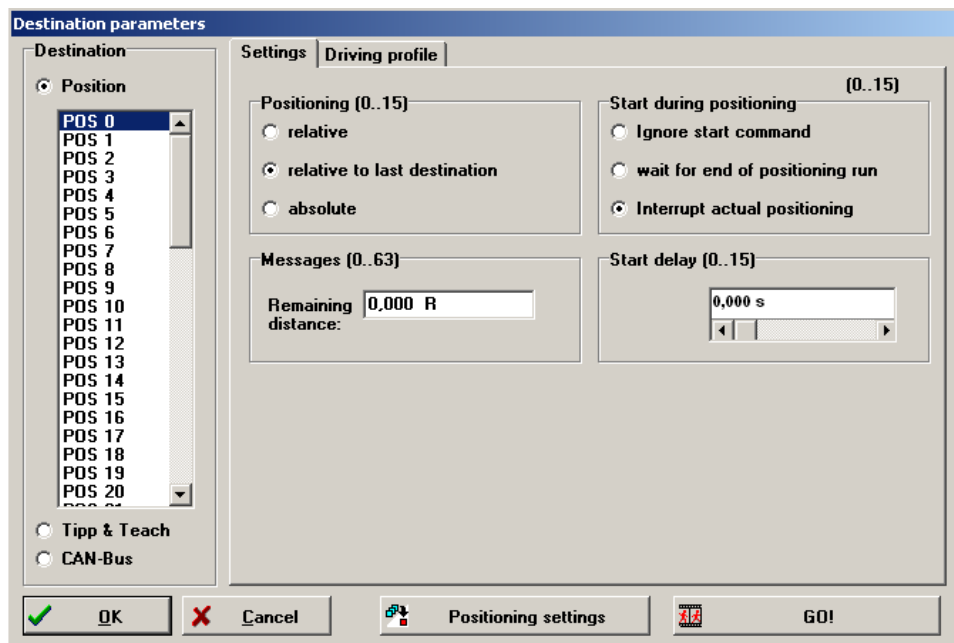

You can select the positioning set which is to be parametrized in the **Destination** section on the left. In use of 64 positioning sets, these sets are divided into 4 position groups (0...15, 16...31, 32...47, 48...63).

If the option "**16 Positions / 16 driving profiles**" is activated in the menu **Settings position sets / Course program**, only 16 position sets are available. These position sets, however, can be parametrized completely independently.

As an alternative to the displayed motion profile from the standard position sets 0..15 or 0..63, the motion profile from the options "CAN Bus", which has been parametrized via the CAN Bus and "Tipp & Teach" can be also displayed and modify here.

The information (0...15) after the field name **Positioning** indicates that the selection "**relative**" applies to all positions in the 0 to 15 position group. Some of the other parameters in this menu apply to all 64 positions. In this case the field name is followed by (0...63). If no information is given after the field name, the parameter applies only to this position.

The **Positioning** field can be used to state whether the specified destination should be interpreted as an **absolute** value (referring to the reference point) or as a **relative** value. **Relative** refers to the current position setpoint, e.g. during a positioning run being performed. The option **relative to last destination** calculates the new position on the basis of the destination reached or currently being approached.

The **relative** option leads to different results depending on the setting in the field **Start during positioning** (see below). If the combination **relative / Wait for end of positioning run** is selected, the new position refers to the destination.

In the case of the combination **relative/Interrupt actual positioning**, the new destination will be calculated starting from the current positioning setpoint.

The field **Start during positioning** defines the behaviour of the servo positioning controller when a positioning run is still running and the controller receives a start command for a new destination. It has the following options:

- ❖ **Wait for end of positioning run:** The current positioning run will be completed before the new positioning process is started. The next positioning run can be selected prior to the running positioning run. The new positioning run will be started automatically when the current positioning run is completed.
- ❖ **Interrupt actual positioning:** The current positioning run will be interrupted and the new position will be approached immediately.
- ❖ **Ignore start command:** The positioning command for the new position cannot be selected or started before the current positioning run is completed.



Please note that a bouncing switch at the digital start input may lead to problems if **wait for end of positioning run** or **interrupt actual positioning** is allowed in the case of a relative positioning run. As a result, the drive may move just a little too far!

The **Messages** field can be used to parameterize trigger signals which can be issued via the field bus or a digital output. These trigger signals indicate the **remaining distance** up to the end of a positioning run. The parameterized remaining distance applies to all 64 destinations.

Information on how to feed this message to the digital outputs can be found in *chapter 5.5 Digital outputs DOUT0 to DOUT3*.

The **Start delay** field can be used to define a certain delay period. After a start command, the servo positioning controller has to wait until this delay is over before it can start the positioning run.

Tab: Driving profile

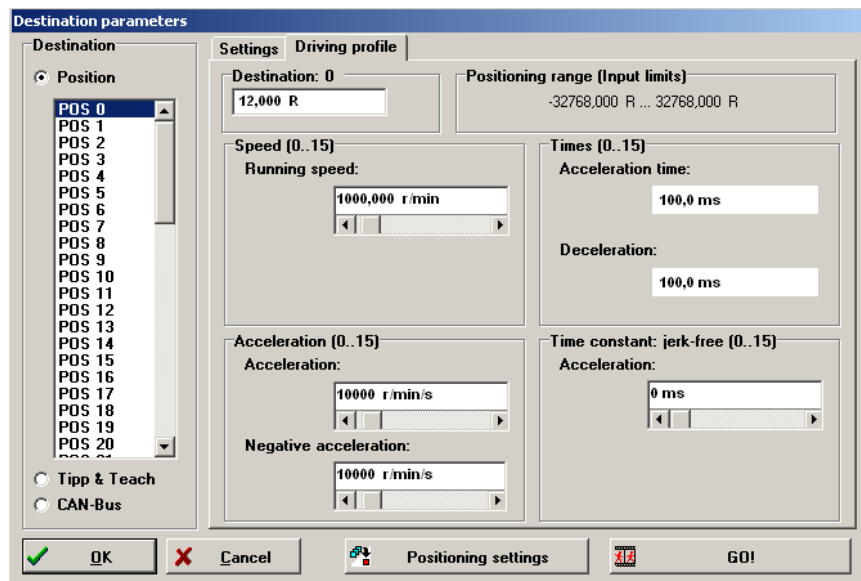

You can enter the destination into the **Destination** field. The destination will be interpreted in different ways depending on whether the user has selected an absolute positioning run or a relative positioning run. (See the **Settings** tab)

The **Speed** field can be used to enter the **Running speed** used to approach the destination. The **final speed** is always zero and cannot be parameterized.

The values for accelerating or decelerating the drive can be entered into the **Acceleration** field.

The **Times** field shows the times resulting from the running speed and the accelerations.

The field **Time constant: jerk-free** can be used to define a filter time used to smooth the acceleration ramps in order to realize a jerk-limited acceleration. The following illustrations show the speed profile of a positioning run with and without a jerk-limited acceleration.

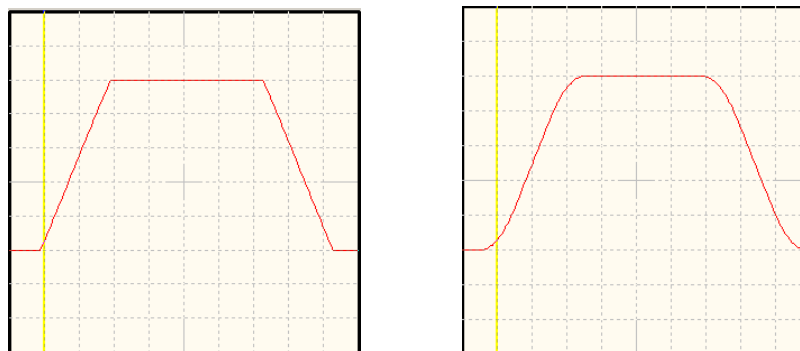

Figure 8: Time-optimal and jerk-limited positioning

The positioning range configured under **Parameters/Positioning/Settings position sets/Course program** is displayed in the field **Positioning range (Input limits)**.



The settings of the setpoint ramp have no effect on the motion profile during homing or in the positioning mode.

Approaching destinations There are different ways to select destinations and to start positioning runs:

❖ Through the digital inputs:

The destinations are selected through the digital inputs (DIN0...DIN5).

When there is a rising edge at digital input DIN6, the destination is adopted and the positioning run is started. Information on how to configure the digital inputs for the positioning run can be found in *chapter 5.3 Digital inputs DIN0 to DIN9*.

❖ Through the serial interface:

The movement to the destination position and the homing run can be started via the parametrization program. To do so, activate the menu **Parameters/Positioning/Go to destination**. You can move to the desired destination by clicking on the corresponding button. You can also click the **GO!** button to start a positioning run and to move to the destination currently being displayed (see also *chapter position sets*). In the lower section of the window, you can make settings for the course program. If you select **Course Program active**, the course program will be enabled in the positioning mode. The button opens the course program menu (see *chapter Course program*). In addition you can define two start lines for the course program.



Setting of digital outputs

In the positioning mode, a superimposed control system can be informed through digital outputs of the fact that a positioning run has been/is being completed.

The digital outputs can transfer the following information:

- ❖ Target reached.
- ❖ Remaining distance up to the end of a positioning run reached.
- ❖ Homing run performed.

The configuration of the digital outputs is described in *chapter 5.5 Digital outputs DOUT0 to DOUT3*.

Homing

Most applications using the DUET_FL servo positioning controller in positioning mode require a zero position to which the position controller can refer. This position is called **home position** and has to be re-determined whenever the controller is switched on. This is done during a so-called **homing run**. Several methods are available for this.



Absolute value encoders (e.g. SinCos encoders with multiturn functionality) are an exception. These encoders do not need to be homed.

Homing methods There are 4 possible targets for the homing run:

- ❖ Homing run to the negative or positive limit switch with or without the index pulse of the angle encoder.
- ❖ Homing run (without additional signal) to the negative or positive stop.
- ❖ Homing run to the index pulse of the angle encoder.
- ❖ No movement.

The homing run is started by enabling the controller or through the field bus. When the homing run is completed successfully, this is indicated by a set status bit in the device. This status can be evaluated through a field bus or through a digital output.

The different homing methods are explained in the following sections. The numbers in little circles in the pictures correspond to the home positions of the corresponding homing method. The number do not correspond to the homing method numbers defined in CANopen DSP402.

Chapter Parameterizing the homing run describes how to active the homing methods and how to set the required parameters.

Method 1: Negative limit switch with index pulse evaluation

If this method is used, the drive moves in the negative direction at search speed until it reaches the negative limit switch. In Figure 9 this is represented by the rising edge (movement from the right to the left). Then the drive moves back at crawl speed and tries to find the exact position of the limit switch. The zero position refers to the first index pulse of the angle encoder in the positive direction from the limit switch.



Figure 9: Homing run to the negative limit switch with index pulse evaluation

Method 2: Positive limit switch with index pulse evaluation

If this method is used, the drive moves in the positive direction at search speed until it reaches the positive limit switch. In Figure 10 this is represented by the rising edge. Then the drive moves back at crawl speed and tries to find the exact position of the limit switch. The zero position refers to the first index pulse of the angle encoder in the negative direction from the limit switch.

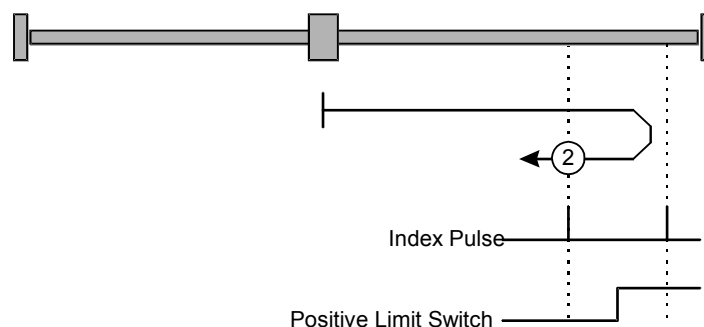

Figure 10: Homing run to the positive limit switch with index pulse evaluation



In the case of homing methods 1 and 2, you have to make sure that the index mark or the index pulse of the encoder does not coincide with the switching edge of the limit switch or that it is located near the switching edge, as this may lead to a home position offset of one motor rotation.

Method 17: Homing to the negative limit switch

If this method is used, the drive moves in the negative direction at search speed until it reaches the negative limit switch. In Figure 11 this is represented by the rising edge. Then the drive moves back at crawl speed and tries to find the exact position of the limit switch. The zero position refers to the falling edge of the negative limit switch.



Figure 11: Homing to the negative limit switch

Method 18: Homing to the positive limit switch

If this method is used, the drive moves in the positive direction at search speed until it reaches the positive limit switch. In Figure 12 this is represented by the rising edge. Then the drive moves back at crawl speed and tries to find the exact position of the limit switch. The zero position refers to the falling edge of the positive limit switch.

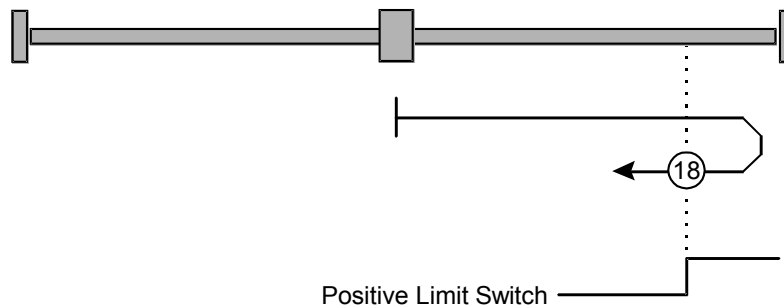

Figure 12: Homing to the positive limit switch

Methods 33 and 34: Homing to the index pulse

In the case of method 33 and method 34 the direction of the homing run is negative or positive. The zero position refers to the first index pulse of the angle encoder in search direction.

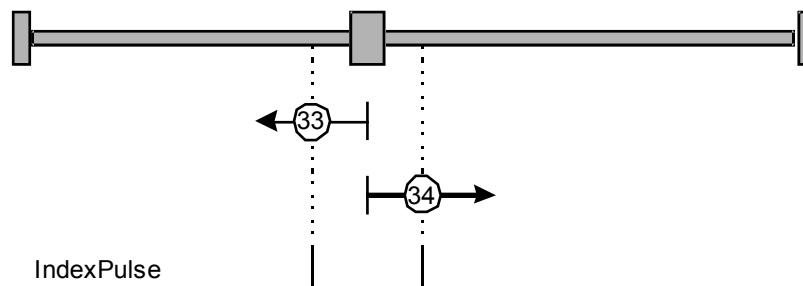

Figure 13: Homing run referred only to the index pulse

Method -1: Negative stop with index pulse evaluation

If this method is used, the drive moves in the negative direction until it reaches the stop. The DUET_FL servo positioning controller needs at least 1 second to recognize the stop. The mechanical design of the stop must be such that it cannot be damaged at the parameterized maximum current. The zero position refers to the first index pulse of the angle encoder in the positive direction from the stop.



Figure 14: Homing run to the negative stop with index pulse evaluation

Method -2: Positive stop with index pulse evaluation

If this method is used, the drive moves in the positive direction until it reaches the stop. The DUET_FL servo positioning controller needs at least 1 second to recognize the stop. The mechanical design of the stop must be such that it cannot be damaged at the parameterized maximum current. The zero position refers the first index pulse of the angle encoder in the negative direction from the stop.

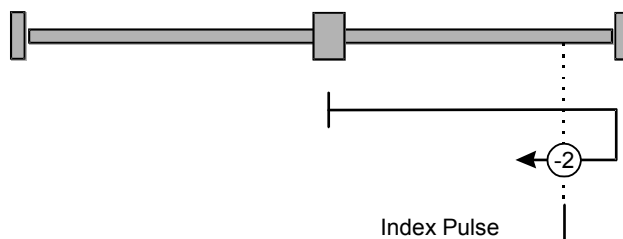

Figure 15: Homing run to the positive stop with index pulse evaluation

Method -17: Homing to the negative stop

If this method is used, the drive moves in the negative direction until it reaches the stop. The DUET_FL servo positioning controller needs at least 1 second to recognize the stop. The mechanical design of the stop must be such that it cannot be damaged at the parameterized maximum current. The zero position refers directly to the stop.

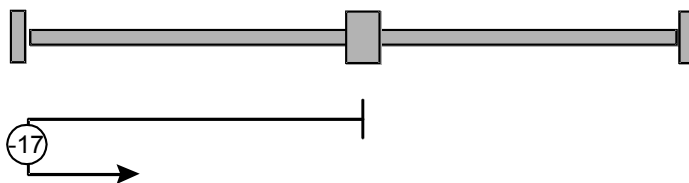

Figure 16: Homing to the negative stop

Method -18: Homing to the positive stop

If this method is used, the drive moves in the positive direction until it reaches the stop. The DUET_FL servo positioning controller needs at least 1 second to recognize the stop. The mechanical design of the stop must be such that it cannot be damaged at the parameterized maximum current. The zero position refers directly to the stop.

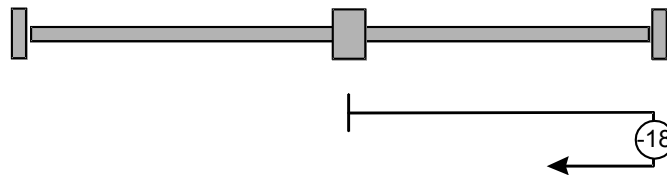

Figure 17: Homing to the positive stop



Do not use homing methods 16 and 17 unless the mechanical system of the positioning axis is configured accordingly. Set the running speed as low as possible in order to limit the kinetic energy when the drive hits the stop.

Method 35: Homing to the current position (no movement)

In the case of method 35, the zero position refers to the current position when the homing run is started.

Parameterizing the homing run

The homing run can be parameterized in the **Homing position** menu. You can open this menu under **Parameters/Positioning/Homing position** or by clicking the **REF** button in the tool bar.

The following window will appear:

The **Positioning settings** button will lead you to the menu for parameterizing the general positioning settings (e.g. positioning limits). See *chapter Global positioning settings*.

Click **GO!** if you want to start a homing run.

Tab: Settings

You can select one of the homing methods described in *chapter Homing methods* in the **Mode** field. During the homing run, the motor will run until the **Destination** has been activated.

The **No movement** method is a special case. In this case, the current actual position is defined as the homing position. In this case, the drive will not move at all.

In all other cases, the destination will be approached at **search speed**. Then the drive moves back at **crawl speed** to determine the exact contact threshold. The **running speed** is used to approach the **home position** (zero point of the application). This may differ from the **destination**. The index pulse, for instance, is preferred as the home position as it has a higher level of accuracy.

You can find the settings for the search, crawl and running speed or the corresponding acceleration on the **Driving profile** tab for the speed, acceleration and time values. This tab will be described in detail below.

If there is a certain distance between the actual homing position, i.e. the calculated zero point for the subsequent positioning runs, and the home position of the homing run, this distance can be entered into the **Offset start position** field.

If the option **Go to zero position after homing run** is selected, the drive will move to the zero position at **running speed** after the homing run has been performed.



If you select this option, make sure that the zero position is not located behind the **destination** of the homing run as this would cause a homing run error.

You can define a **maximum search path**. If the DUET_FL servo positioning controller cannot detect a limit switch signal within this search distance, it will issue an error message. The search path is based on the maximum position limits. The **Max. position limits** button will lead you to the menu for parameterizing the general positioning settings (e.g. positioning limits). See *chapter Global positioning settings*.

If the option **Homing run at controller enable** is selected, the homing run will be started automatically once the controller is enabled.

Tab: Driving profile

Here you can enter **Speed** and **Acceleration** values for the following processes:

- ❖ Search: Movement of the drive until it reaches the destination (limit switch, stop)
- ❖ Crawl: Reversal of movement (at low speed) to determine the contact threshold.
- ❖ Running: Optional movement to the zero point (home position) of the application.

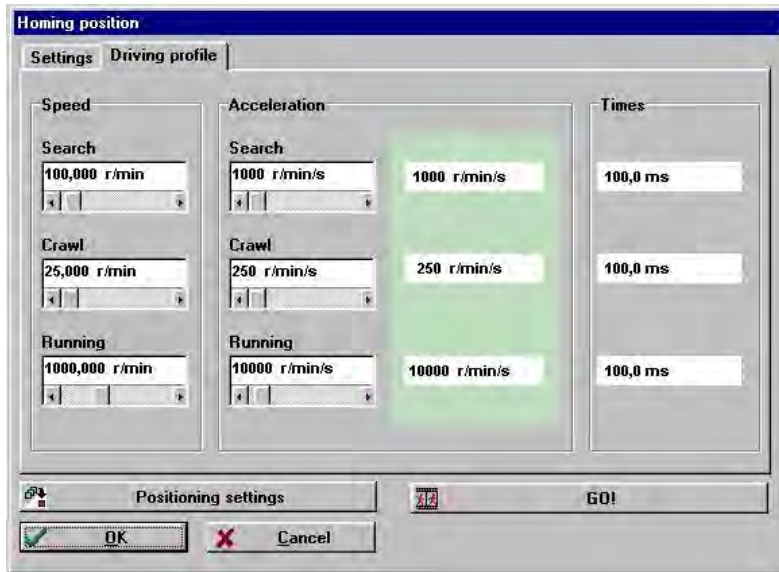

Course program

A course program allows several position sets to be linked together in one sequence. These positions will be approached one after the other. A course program has the following characteristics:

- ❖ Up to 32 course program steps can be set.
- ❖ Apart from linear sequences, which are terminated sooner or later, circular linking is also possible.
- ❖ A special digital input can be used to approach a position "out of turn" within the course program. This position can be selected using digital inputs.
- ❖ Up to 2 following positions can be set for every course program step. As a result, a course program can include branching. Branching occurs depending on the logic status of digital inputs.
- ❖ The course program can control two digital outputs. For this purpose, every course program step offers 4 different options (on, off, target reached, remaining distance message).



Please note: On the DUET_FL 48/10 and on the DUET_FL 48/10 IC the digital outputs DOUT1 and DOUT2 are connected to the same pins as the digital inputs DIN2 and DIN3. If you use the outputs, the control of the course program is subject to certain restrictions! Please use the DUET_FL 48/10 FB in this case.

In the DUET_FL 48/10 FB, the digital inputs and outputs are led out separately.

- ❖ There are two alternative start points for starting the course program. The start points can be parametrized as desired and are started with the help of digital inputs. As a result, you can either create a course program with two start points or - as an alternative - two smaller course programs with up to 32 steps which can be called up completely independently.
- ❖ A course program can be created and monitored in a comfortable manner in the parametrization interface. The application thus created can be saved in the parameter set or - as an alternative - in a course program file. It can be transferred to other DUET_FL servo positioning controllers.
- ❖ The program lines of the course program are processed every 1.6 ms. This ensures that an output set by the course programs remains set for at least 1.6 ms.

The course program mode can be activated through the corresponding button in the commands window (see *chapter Activating the operating mode*). The setting can be saved permanently in the servo positioning controller.

The course program is controlled through the digital inputs. Digital inputs which are subject to level evaluation (high/low) have to be pending stably for at least 1.6 ms (course program processing time) so that the level can be detected safely. Edge-sensitive inputs have to be pending for at least 100µs.

Digital inputs, which are normally used for starting and assigning a position set, are used as follows when a course program is active:

Table 8: Course program: Assignment of the digital inputs

DIN:	Function:	Explanation:
DIN 0	NEXT2	Rising edge: Continue with following position 2.
DIN 1	NEXT1	Rising edge: Continue with following position 1. (NEXT1 has a higher priority than NEXT2 if both are switched simultaneously)
DIN 2	#STOP	Low = A running positioning run will be interrupted. The program stops in the current course program line.
DIN 3	Course/Posi	High = Activation of the course program. Low = Complete movement to position. Then normal positioning mode with destination selection through DIN0, DIN1, DIN2 and position group selection through DIN4 and DIN5.
DIN 4	START1	Rising edge: Movement to a defined start position. Start of the course program.
DIN 5	START2	Rising edge: Movement to a defined start position. Start of the course program. (START1 has a higher priority than START2 if both are switched simultaneously)
DIN 6	Start positioning / homing	Rising edge: If DIN3 low: Start positioning If DIN 3 high: Start homing

Table 9: Course program: Configuration of the digital inputs (new I/O configuration)

DIN:	Function:	Explanation:
DIN 0	Course/Posi	High = Activation of the course program. Low = Complete movement to position. Then normal positioning mode with destination selection through DIN0, DIN1, DIN2 and position group selection through DIN4 and DIN5.
DIN 1	#STOP (active low)	Low = A running positioning run will be interrupted. The program stops in the current course program line.
DIN 2	NEXT2	Rising edge: Continue with following position 2.
DIN 3	START2	Rising edge: Movement to a defined start position. Start of the course program. (START1 has a higher priority than START2 if both are activated simultaneously)
DIN 4	NEXT1	Rising edge: Continue with following position 1. (NEXT1 has a higher priority than NEXT2 if both are activated simultaneously)
DIN 5	START1	Rising edge: Movement to a defined start position. Start of the course program.
DIN 6	Start positioning / homing	Rising edge: If DIN3 low: Start positioning If DIN 3 high: Start homing

The new IO configuration that is shown in table 9 ensures a better utilization of the functions in the course program in spite of the double utilization of the signals DIN2 / DOUT1 and DIN 3 / DOUT2 on the X1 connector. It can be activated through the corresponding check box in the commands window.

If the digital input **Course/Posi** is set to 0 V, the course program is inactive. Normal positioning runs can be called up through the digital inputs, but as shown in table 10, the number of destinations is reduced by half, i.e. to 32 or 8 destinations depending on the operating mode.

Table 10: Available position sets if the course program is active and the Course/Posi input = 0

Configuration :	64 positions:	16 positions:	Explanation:
Table 8	4 groups with 8 positions each Pos. 0..7, 16..23, 32..39, 48..65	8 complete positions Pos. 0..7	Standard configuration Control signal Course/Posi at DIN 3
Table 9	4 groups with 8 positions each Pos. 0, 2, 4, 6, ... 60, 62	8 complete positions Pos. 0, 2, 4, 6, 8, 10, 12, 14, 16	New configuration Control signal Course/Posi at DIN 0

Creating a course program

The menu for managing and creating course programs with up to 32 program lines can be opened under **Parameters/Positioning/Course program**.

Nr.	CMD	STOP	NEXT1	Pos/line 1	NEXT2	Pos/line 2	DOUT1	DOUT2
0	Posi	ignore	complete(pos.)	0	ignore	-	Off	Off
1	Posi	ignore	ignore	-	complete(pos.)	1	Off	Off
2	Posi	ignore	complete(pos.)	2	ignore	-	Off	Off
3	Posi	ignore	ignore	-	complete(pos.)	3	Off	Off
4	Posi	ignore	complete(pos.)	4	ignore	-	Off	Off
5	Posi	ignore	ignore	-	complete(pos.)	5	Off	Off
6	Posi	ignore	complete(pos.)	6	ignore	-	Off	Off
7	Posi	ignore	ignore	-	complete(pos.)	7	Off	Off
8	Posi	ignore	complete(pos.)	8	ignore	-	Off	Off

Modus: Debug Edit

File >> Program Edit line Program >> File Exit

The **File >> Program** can be used to load an already existing course program into the servo positioning controller while the **Program >> File** button can be used to save a program just created.

In the **Modus** field, you can select either the input mode **Edit** or the monitoring mode **Debug**. The monitoring mode is described in detail in *chapter Debugging a course program*.

If you click the **Edit line** button or a line in the table, another window opens in which you can define commands for the selected course program line.

The program offers the following basic course program commands

- ❖ Position branch (and linear position sequence)
- ❖ Branch (Line)
- ❖ Level test (and unconditional program jump)
- ❖ End of program

Chapter Course program: Examples includes three small example applications for a course program.

The various course programs are explained in detail in *chapter End of program to Level test*.

Course program options

In the **Options** field, you can define the evaluation of the digital inputs NEXT1 and NEXT2. If you have selected **Evaluate NEXT1** or **Evaluate NEXT2**, the lower section of the window will show an additional field with the input options for the corresponding signal.

- ❖ **Ignore, if target not reached:** If the signal comes in while a positioning run is running, it will be ignored. If no positioning run is currently being performed, the new following position / following line X will be approached.
- ❖ **Go to position / line immediately:** The new following position / following line X will be approached immediately. The positioning run currently being performed will be interrupted immediately.
- ❖ **Complete position, then target / line:** The current positioning run will be completed. Then the following position / following line X will be approached in accordance with the incoming signal.

The following applies always:

- ❖ If both NEXT signals are not set to "evaluate", following position / following line 1 will be approached.
- ❖ If NEXT1 is set to "evaluate" but NEXT2 is parameterized differently, NEXT1 will be used.
- ❖ If NEXT2 is set to "evaluate" but NEXT1 is parameterized differently, NEXT2 will be used.

In addition, you can select the following statuses for the digital outputs DOUT1/DOUT2 in the **Options** field:

- ❖ ON
- ❖ OFF
- ❖ Target reached
- ❖ Remaining distance message

The following applies always:

- ❖ The options "ON" and "OFF" will be adopted immediately.
- ❖ The options "target reached" and "remaining distance message" will not be adopted until the positioning run of the course program line is started.

The response to the STOP signal can also be configured in the **Options** field. If the digital stop signal is evaluated, the following actions will be performed:

- ❖ A running positioning run will be interrupted. The drive will slow down with the deceleration ramp. When the stop signal reaches the HIGH level again, the positioning run will be continued.
- ❖ The position branch will not be performed. The program will remain in the current program line.
- ❖ The edge evaluation of the signals NEXT1 and NEXT2 will be continued even if the stop signal is active.
- ❖ The outputs DOUT1 and DOUT2 will not be affected by the stop signal.

End of program

Course program line 21

Befehlsart

- Position branch
- Branch (Line)
- Level test
- End of Program

Optionen

- Evaluate Stop signal

A running positioning run will be completed. Then the program will be stopped at this point. No digital outputs will be set / reset. No other positioning run will be started.

If the check box **Evaluate stop signal** is selected, the running positioning run can be interrupted.

Position branch

Course program line 0

Befehlsart

- Position branch
- Branch (Line)
- Level test
- End of Program

Optionen

- Evaluate NEXT1
- Evaluate NEXT2
- Evaluate Stop signal

DOUT1

DOUT2

NEXT1

Following position 1

- Ignore, if target not reached
- Go to position immediately
- Complete position, then target

NEXT2

Following position 2

- Ignore, if target not reached
- Go to position immediately
- Complete position, then target

Different positions are approached depending on NEXT1 and NEXT2. The course program continues in the following command line.

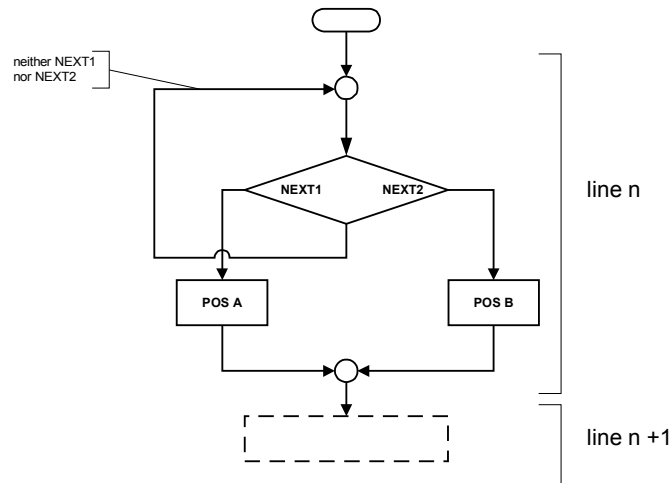

Figure 18: Course program - Position branch

If the digital signal NEXT1 is set to HIGH (rising edge), position A will be approached. If the digital signal NEXT2 is set to HIGH (rising edge), position B will be approached. If the program cannot detect any rising edges, the course program will remain in a waiting state.

If neither **Evaluate NEXT1** nor **Evaluate NEXT2** have been selected, the drive will always approach the position set under NEXT1. Thus, a linear positioning run (e.g. POS1→POS2→POS3) can be performed.

In Figure 19 it is assumed that a positioning run will be started in program step 10. When the positioning run is started (10), the course program switches to the next line, program step 11.

If we assume that NEXT1/2 has been set to "Complete position, then target", the inquiry of the NEXT1/2 inputs takes place at the far end of the program step when the "target reached" message has been activated. However, the system also evaluates the edges that have been detected since the start of the positioning run. If the "target reached" signal has been set but the system has not detected a rising edge of NEXT1/2, the program will remain in program step 11 until at least one edge of NEXT1/2 is detected.

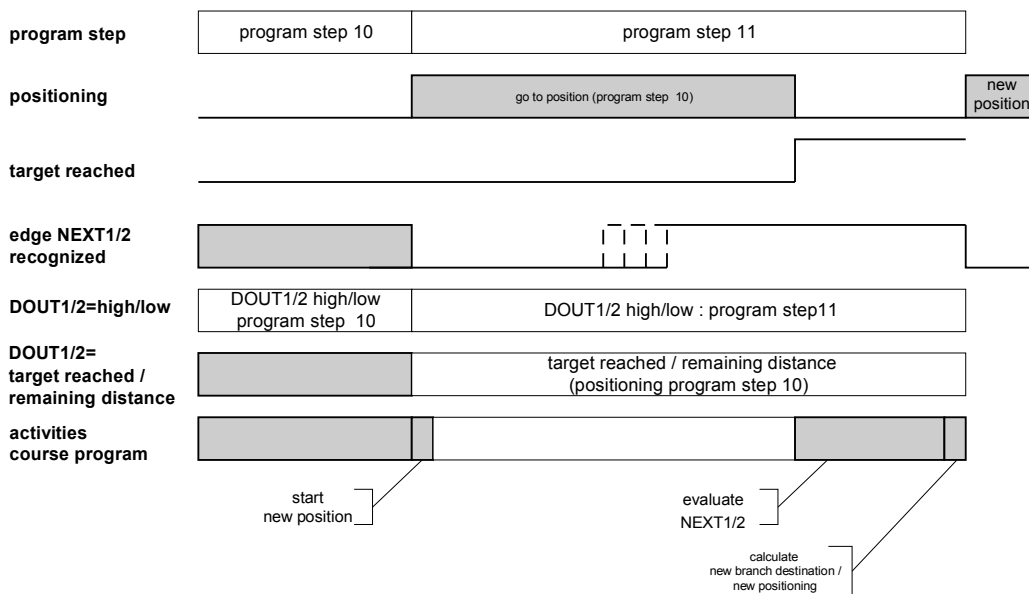
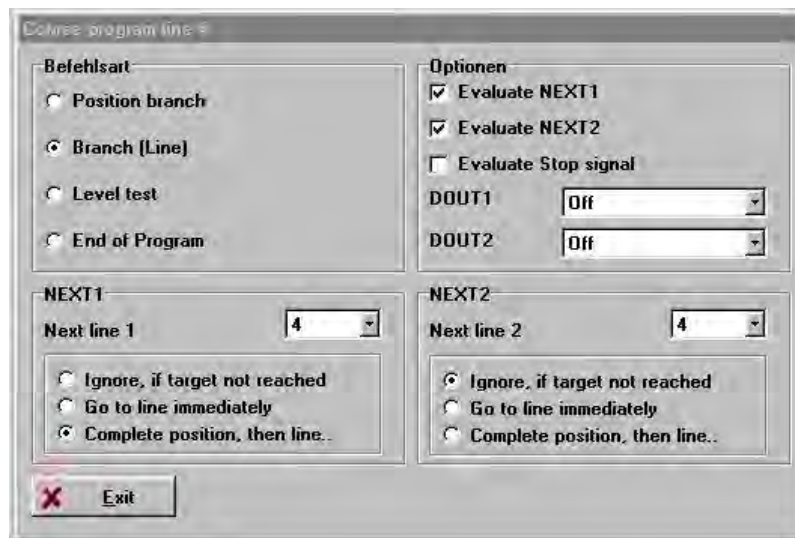

Figure 19: Position branch time diagram

Branch (Line)



Depending on NEXT1 and NEXT2 the program continues in different lines. If the digital signal NEXT1 is set to HIGH (rising edge), the program will continue in line X. If the digital signal NEXT2 is set to HIGH (rising edge), the program will continue in line Y. If the program cannot detect any rising edges, the course program will remain in a waiting state.

If neither **Evaluate NEXT1** nor **Evaluate NEXT2** have been selected, you can state a next line which will be used automatically.

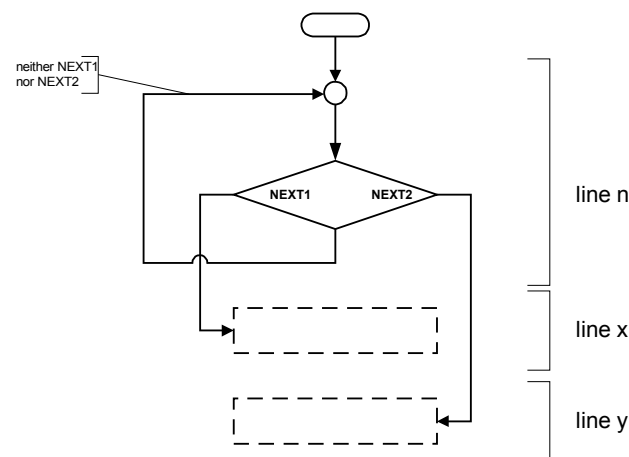

Figure 20: Course program - Branch (Line)

In Figure 21 it is assumed that a positioning run was started in program step 10. When the positioning run is started (10), the course program switches to the next state.

Assuming that NEXT1/2 has been set to "Go to line immediately", the NEXT1/2 inputs will be inquired in the course of the currently active positioning process. We also assume that the NEXT1/2 signal becomes active before the positioning run is completed. The evaluation takes place and the corresponding course program line (next line 1 or 2, depending on whether NEXT1 or NEXT2 has become active first) will be accessed and processed.

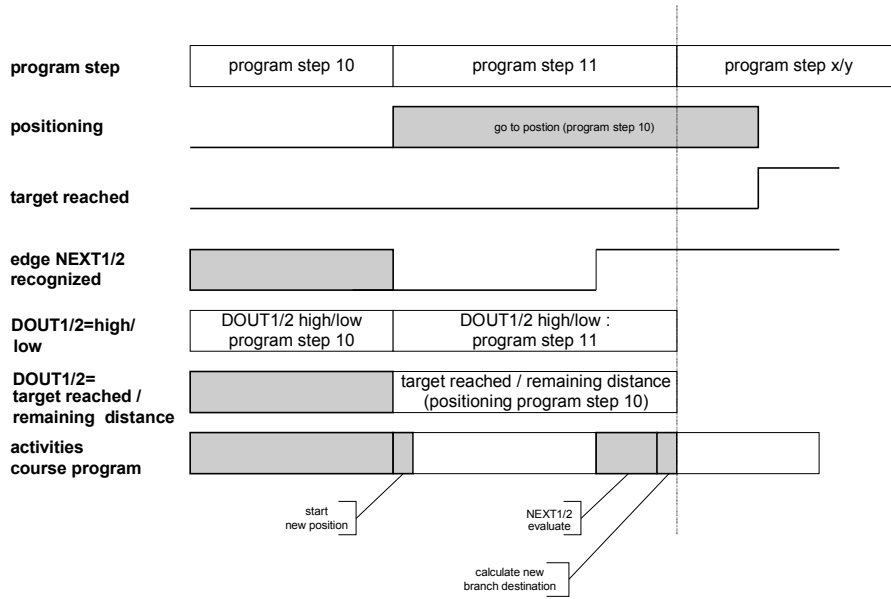
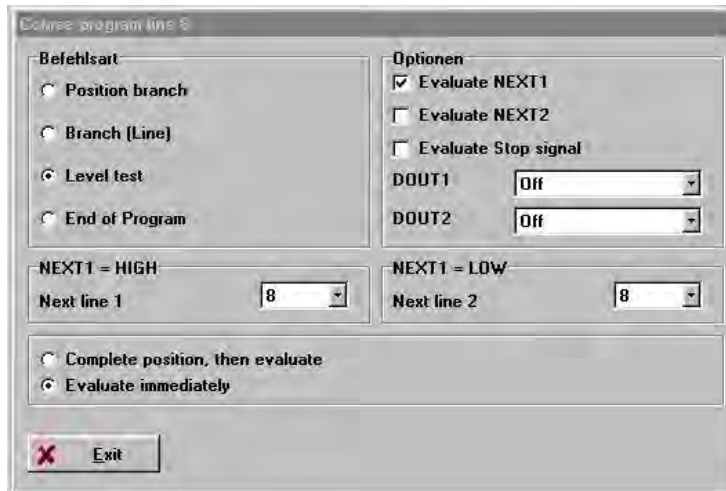

Figure 21: Branch (Line) time diagram

Level test



Depending on the level of NEXT1, the program will continue in different lines.

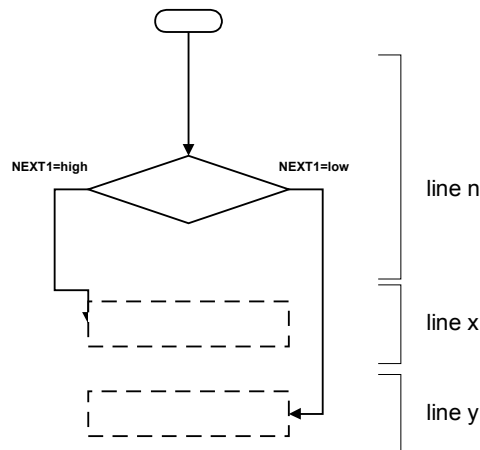

Figure 22: Level test course program

If the digital signal NEXT1 is HIGH, the program will continue in line X. If the digital signal NEXT1 is LOW, the program will continue in line Y.

An unconditional program jump (e.g. for infinite loops) can be generated by stating the same branch destination for NEXT1=HIGH and NEXT1=LOW.

In Figure 23, the level test of NEXT1/2 is performed immediately at the start of program step 11. The line of the next course program command is determined depending on the result of this level test.

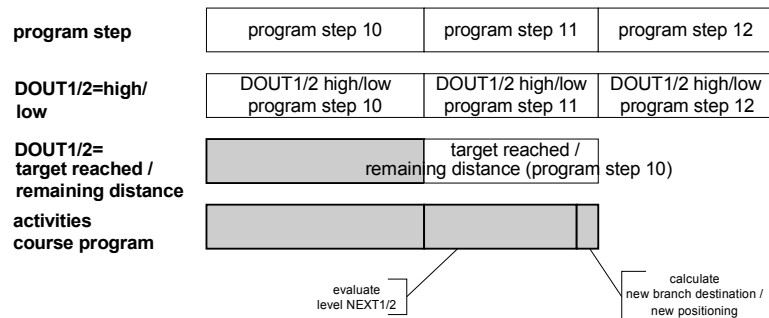

Figure 23: Level test time diagram

Debugging a course program

If you switch to **Debug** mode, additional status information will be displayed in the course program window:

- ❖ Course program active: Indicates that the course program is running and being processed.
- ❖ Course program stop: Indicates that the course program has been stopped by the #stop signal.
- ❖ NEXT1 / NEXT2: Shows the current status of the digital inputs for NEXT1 & 2.
- ❖ DOUT1 / DOUT2: Shows the current status of the digital outputs DOUT1 & 2.
- ❖ Line: Shows the current line of the course program. In addition, the current line is highlighted in blue in the table.
- ❖ Position: Indicates the position set approach last.

Course program									
Nr.	CMD	STOP	NEXT1	Pos/line 1	NEXT2	Pos/line 2	DOUT1	DOUT2	
0	Posi	ignore	automatic	63	ignore	-	Off	Off	
1	Posi	ignore	automatic	62	ignore	-	Off	Off	
2	Posi	ignore	automatic	61	ignore	-	Off	Off	
3	Posi	ignore	automatic	50	ignore	-	Off	Off	
4	Jump	ignore	ignore (target)	5	ignore (target)	10	On	Target	
5	Posi	ignore	automatic	10	ignore	-	On	Off	
6	Posi	ignore	automatic	11	ignore	-	On	Off	
7	Posi	ignore	automatic	12	ignore	-	On	Off	
8	Posi	ignore	automatic	40	ignore	-	On	Off	

Modus: Debug Edit

Course program active NEXT1 DOUT1 Line: 4

Course program stop NEXT2 DOUT2 Position: 50

Function of the inputs and outputs



Information concerning the pin assignment of the inputs and outputs can be found in *chapter Connectors at the DUET_FL 48/10*.

5.3 Digital inputs DIN0 to DIN9

The DUET_FL servo positioning controller has ten digital inputs (**DIN0** to **DIN9**).

Due to the limited number of connectors at the pin-and-socket connector some of the digital inputs are not active in all configurations.

The following table provides an overview of the configuration in which the digital inputs cannot be used (X = not available):

Table 11: DUET_FL 48/10 digital inputs - possible combinations

	DIN0	DIN1	DIN2	DIN3	DIN4	DIN5	DIN6	DIN7	DIN8	DIN9
Analog inputs active	X	X	X	X						
CAN active					X	X				
Incremental encoder emulation active			X	X						
Analog monitor active							X			
Digital outputs 1 & 2 active			X	X						

Table 12: DUET_FL 48/10 IC digital inputs - possible combinations

	DIN0	DIN1	DIN2	DIN3	DIN4	DIN5	DIN6	DIN7	DIN8	DIN9
Analog inputs active	X	X	X	X						
CAN active					X	X				
Incremental encoder emulation active			X	X						
Analog monitor active										
Digital outputs 1 & 2 active			X	X						

Table 13: DUET_FL 48/10 FB digital inputs - possible combinations

	DIN0	DIN1	DIN2	DIN3	DIN4	DIN5	DIN6	DIN7	DIN8	DIN9
Analog inputs active	X	X	X	X						
CAN active										
Incremental encoder emulation active			X	X						
Analog monitor active										
Digital outputs 1 & 2 active										

An overview of the available digital inputs and their current assignment can be found in the menu **Display/Digital inputs**:



Table 14: Digital inputs - assignment

Input	Function	Description
DIN0	Selection of positioning parameter set or course program control	Positioning mode: <ul style="list-style-type: none"> DIN5 & DIN4: Selection of the positioning parameter group (accelerations / times, positioning speeds) DIN3 - DIN0: Selection of the destination within a group Course program mode: <ul style="list-style-type: none"> See <i>chapter</i> Course program
DIN1		
DIN2		
DIN3		
DIN4		
DIN5		
DIN6	Positioning start	In the case of a rising edge, the positioning run will be performed using the parameter set selected beforehand
DIN7	Negative limit switch	Positive (DIN8) or negative (DIN7) setpoints are enabled only if the limit switch inputs are passive. (+24V if normally closed contact / 0V if normally open contact) If there is no signal, the drive decelerates to zero speed at the current limit. The power stage remains active.
DIN8	Positive limit switch	
DIN9	Controller enable	In the case of a rising edge, the control system will be initialized and then enabled together with the power stage. In the case of a falling edge, the motor will be decelerated to zero speed and then the power stage will be deactivated.
	Clear error	If the controller is set to "error", the falling edge is used to acknowledge any pending errors. If this is successful, the controller will be set to "ready for operation" mode and the power stage can be re-enabled with the next rising edge.
	Clear limit switch	If the motor has hit the limit switch, the falling edge is used to allow the motor to continue to move in the same direction.

The digital inputs **DIN0 - DIN3** can be used in all operating modes for an offset for the CAN node number. (See *chapter Configuring the digital inputs*)

Configuring the digital inputs

The menu **Parameters/IOs/Digital inputs** can be used to configure the functionality of the digital inputs DIN0 - DIN5.

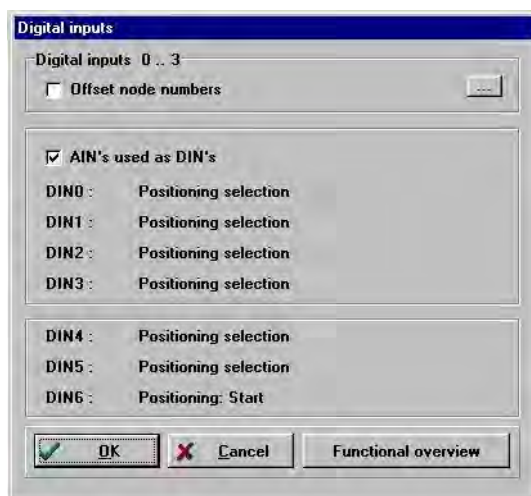

In the positioning mode, a 6 bits wide **position selector** (DIN0 - DIN5) can be configured for addressing a destination on the basis of the 64 freely programmable targets. In addition, the **Start** input (DIN6) is of importance for the positioning run.

The digital inputs DIN0 - DIN3 can be used for an offset for the CAN node address.

i

The functionalities of DIN0 - DIN3 can only be used if the analog inputs AIN0 and AIN1 are used as digital inputs.

If the incremental encoder emulation is active, DIN2 and DIN3 are not available.

5.4 Extended function of the digital inputs (Tipp & Teach)

If the **Tipp & Teach** option is activated in the **Commands** window, the extended function of the digital inputs can be used.

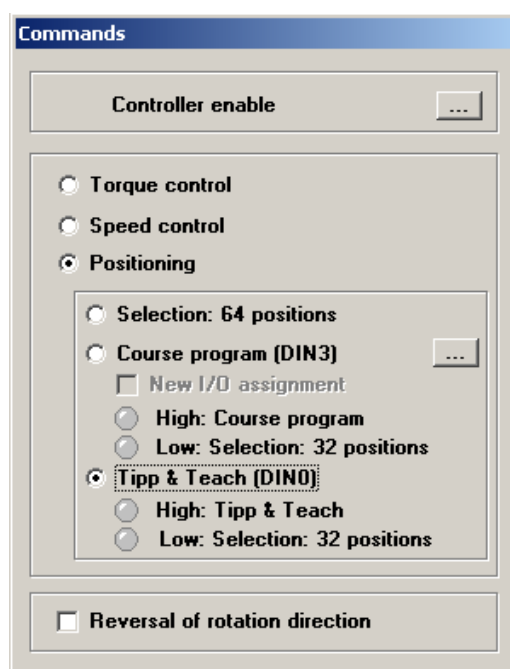

The function is used to approach and program any desired target position through the digital inputs. The programming procedure is described in *section 8.2.1 Teaching positions*. In addition, it is possible to start a homing run through a digital input or to interrupt a positioning run and to stop the drive through another digital input without switching off the output stage.

The digital inputs, which are normally used for starting and assigning a position set, are used as follows when the extended function is active:

Table 15: Tipp & Teach: Configuration of the digital inputs

DIN:	Function:	Explanation:
DIN 0	Spec. / Posi	High = activation of the extended configuration. Low = normal positioning mode with destination selection through DIN1, DIN2, DIN3 and position group selection through DIN4 and DIN5 (Only even position numbers are possible)
DIN 1	#STOP (active low)	Low = a running positioning run will be interrupted. #STOP has a higher priority than Tipp (pos), Tipp (neg) and Homing run: Start. The deceleration ramp that is used for this purpose has to be set in the Safety parameters window. (see chapter 3.3 <i>Selecting safety parameters</i>)
DIN 2	-	-
DIN 3	TEACH	High = activation of the teaching function. (see <i>section 8.2.1 Teaching positions</i>)
DIN 4	Tipp (neg)	High = positioning run in the negative direction with the Tipp & Teach motion parameters. (see <i>chapter position sets</i>)
DIN 5	Tipp (pos),)	High = positioning run in the positive direction with the Tipp & Teach motion parameters. (see <i>chapter position sets</i>)
DIN 6	Start positioning / homing	Rising edge: If DIN 0 low: Start positioning If DIN 0 high: Start homing

8.2.1 Teaching positions

The procedure described below can be used to approach positions (Tipp) through the digital inputs and to save them (Teach) in the controller-internal position sets (up to 64).

The controller must be enabled during the teaching process.

1. Activate the Tipp & Teach mode in the commands window with DIN 0.
Approach the desired target position with DIN 4 / DIN 5.
2. Activate the teaching function (step 1) by setting DIN 3 to high. This deactivates the function "**Homing: Start**" of the digital input DIN 6 and activates the teaching function.
3. Activate the teaching function (step 2) by setting DIN 6 to high.
4. Use the digital inputs DIN 0 to DIN 5 to select the position set into which the current actual position is to be saved.

5. With the falling edge at DIN 6, the current actual position is taken over into the selected position set.
6. The digital inputs will now be ignored for a preset time before they are available again. This time has to be set in the **Destination parameters** window in the **Tip & Teach** position set.



Attention!

The position(s) that is/are written into the position set(s) with the help of the teaching function is/are **not** automatically permanently saved in this/these set(s). They can be saved permanently using the **Save Parameter** button.

The following chronological diagram shows the teaching process of a target position:

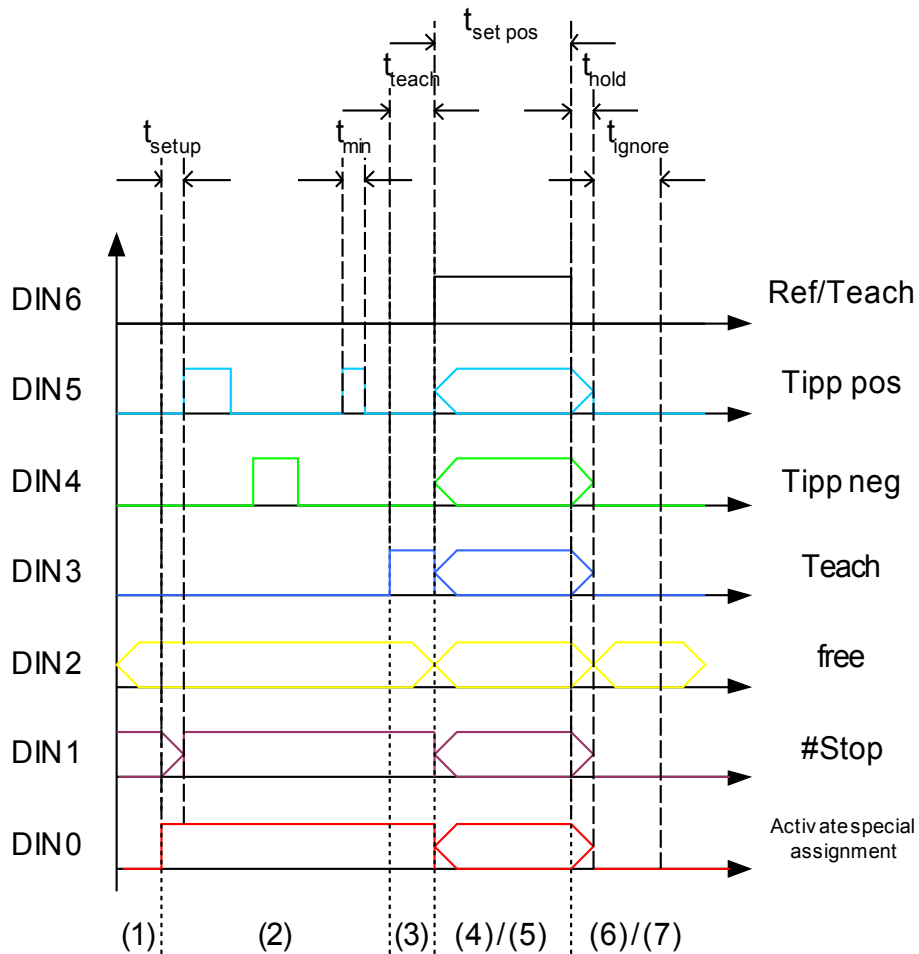

Figure 24: Teaching process of a target position

- $t_{min} \geq 1,6\ ms$
- $t_{setup} \geq 1,6\ ms$
- $t_{teach} \geq 1,6\ ms$
- $t_{set\ pos} \geq 5\ ms$
- $t_{hold} \geq 1,6\ ms$

- $t_{\text{ignore}} \geq 200$ ms (parameterizable)



Attention!

After the time t_{ignore} , the digital inputs re-assume their functionality as it was before the teaching mode.

As a result, the drive may start to move.

5.5 Digital outputs DOUT0 to DOUT3

There are four digital outputs (DOUT0 - DOUT3) to display selected operating states of the DUET_FL servo positioning controller:

- ❖ The DOUT0 output is hard-wired and indicates the readiness for operation of the servo positioning controller. Readiness for operation will be indicated if the DUET_FL servo positioning controller has started after power ON and no error has been detected or if the user has acknowledge an error.
- ❖ The digital outputs (DOUT1 & DOUT2) can have different functions assigned (see *chapter Configuring the digital outputs*).
- ❖ The digital output DOUT3 is permanently assigned to the holding brake (see *chapter 5.6 Holding brake DOUT3*).

An overview of the available digital outputs and their current function assignment can be found in the menu **Display/Digital outputs**.



Configuring the digital outputs

The digital outputs DOUT1 & DOUT2 can be parameterized in the menu **Parameters/IOs/Digital outputs**:



One of the following signals can be assigned independently to DOUT1 or DOUT2:

- ❖ OFF, i.e. output inactive, LOW level through integrated pull-down resistor
- ❖ ON, i.e. output active, 24 V HIGH level through integrated high-side switch

- ❖ Output stage active, i.e. output stage switched on
- ❖ I²t: Motor / Servo
- ❖ Warning
- ❖ Following error
- ❖ Remaining distance message
- ❖ Target reached
- ❖ Homing mode complete
- ❖ Declared speed achieved
- ❖ Course program

Some of the scroll boxes are followed by a button with three dots. Clicking this button opens another window where you can make additional settings.

Configuring the messages for the digital outputs

For many applications combined with a control system, it is useful that the servo positioning controller generates a message when the required operating conditions are violated or reached. The menu item **Parameters/Messages** opens a window for configuring these messages. Here you can configure tolerance ranges for the messages "declared speed achieved", "target reached" and "following error".

Tab: Following error

- ❖ Following error: Tolerance range for the permissible following error.
- ❖ Message delay: Delay during which the actual position must be outside the tolerance window before the "following error" message will be set.

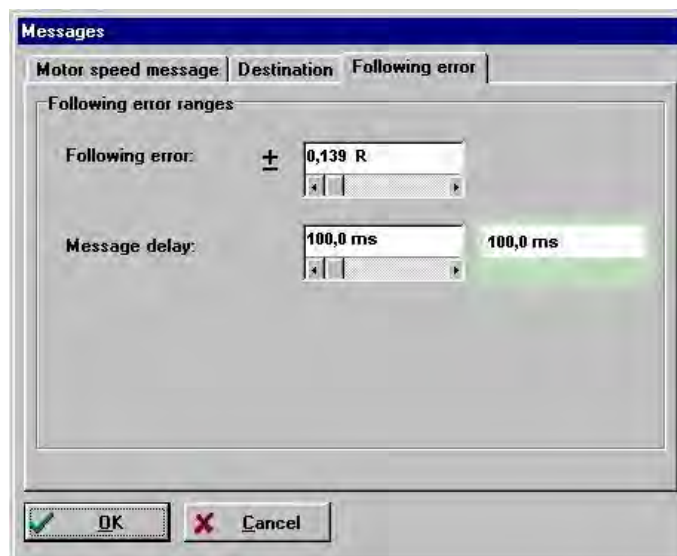

The following error message should be activated in all positioning applications. The recommendable range of the tolerance windows depends on numerous parameters, such as the controller gain in the speed and position control circuit, the resolution of the position detection system etc.

The "Message delay" parameter can be used to increase the "robustness" of the system as it makes sure that not every brief position deviation triggers a following error message.

Tab: Destination

- ❖ Angle/Distance: Tolerance range in which the "target reached" message will be set.
- ❖ Message delay: Delay during which the actual position must be inside the tolerance window before the "target reached" message will be set.

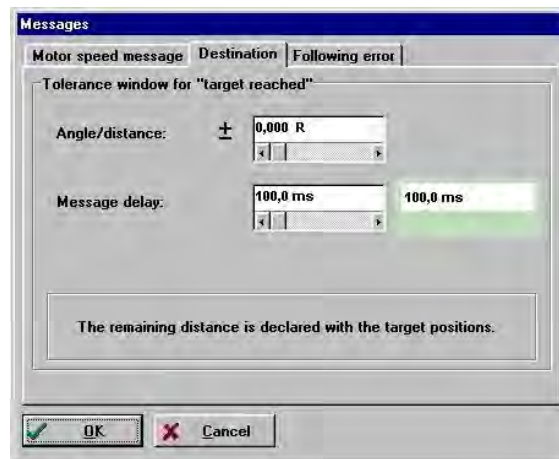
**Tab: Motor speed message**

- ❖ Declared speed: Speed at which the "declared speed achieved" message will be set.
- ❖ Message window: Tolerance range within which the actual speed has to be in the range of the declared speed so that the "declared speed achieved" message is set.

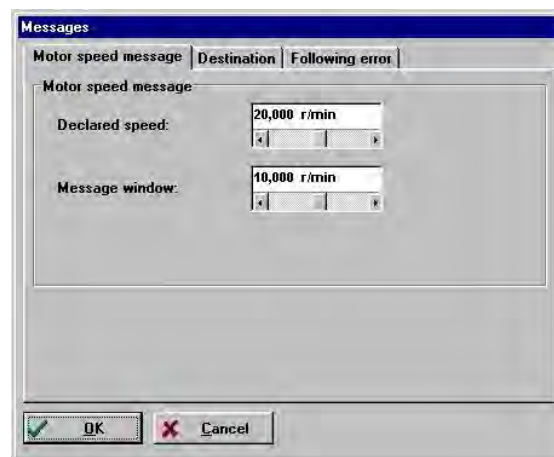

Incremental encoder emulation through DOUT1 and DOUT2



An activated incremental encoder emulation requires the digital outputs DOUT1 and DOUT2. As these outputs are connected to the digital inputs DIN2 and DIN3, these inputs cannot be used if the incremental encoder emulation is active.

Exception: DUET_FL 48/10 FB with DOUT1 and DOUT2 led out separately.

For complex servo control systems, two servo positioning controllers can be synchronized by coupling them in a master-slave configuration using incremental encoder signals. At present, the DUET_FL servo positioning controller can only assume the role of the master. The master transmits the position information in the form of incremental encoder track signals through the outputs DOUT1 (track signal A) and DOUT2 (track signal B) to the slave which receives the information through the corresponding incremental encoder input. The illustration below shows the configuration:

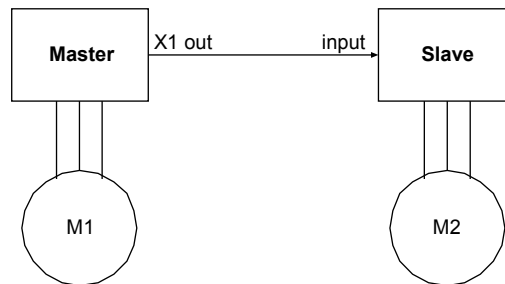

Figure 25: Coupled incremental encoder emulation

The master operates in one of the operating modes described earlier (speed control, positioning) while the slave is in synchronized mode.

Among others, the following applications are possible with this configuration:

- ❖ Speed-synchronous movement
- ❖ Position-synchronous movement
- ❖ Flying saw

Classical servo applications, such as speed control in the servo controller or position control in the control system, also required a feedback of the actual position from the servo controller to the control system. This is also handled using the incremental encoder emulation of the servo positioning controller.

In both cases, the DUET_FL controller as the master emulates the track signals of the incremental encoder defined by the parameters in the menu **Operating mode/Incremental encoder emulation**.

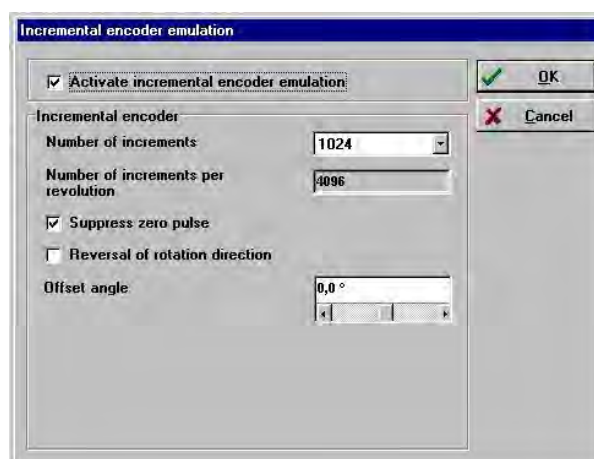

In addition, you can deactivate the incremental encoder emulation in order to be able to use the digital inputs DIN2 and DIN3 or the digital outputs DOUT1 and DOUT2 for other functions.

You can make the following configurations in the **Incremental encoder** field:

- ❖ **Number of increments:** You can select 32, 64, 128, 256, 512 or 1024 as the number of increments for the emulation.

- ❖ **Suppress zero pulse:** If the check box is selected, no index pulse will be issued.
- ❖ **Reversal of rotation direction:** If the check box is selected the direction of rotation of the incremental encoder emulation will be inverted.
- ❖ **Offset angle:** Here you can set an offset between the index position of the encoder of the DUET_FL servo positioning controller and the emulated index pulse.



The outputs DOUT1 and DOUT2 supply signals with a 24 V level, so-called HTL signals. Older or low-cost control systems in particular can directly process these signals. In order to be able to transmit high speeds with a high resolution, DOUT1 and DOUT2 should be equipped with a resistor of 1 kΩ against 0 V. Please contact your local distributor if your control system cannot process HTL signals but RS422-compatible track signals. In many cases, the DUET_FL controller can also be connected to these inputs provided they are equipped with additional resistors.

5.6 Holding brake DOUT3

If your motor has a holding brake, this brake can be controlled by the DUET_FL servo positioning controller as required by the operation. The DUET_FL servo positioning controller can only control holding brake having a rated voltage of 24 V DC.

It has to be connected via the digital output DOUT3 at connector X3. A detailed description concerning the connection of the holding brake and the maximum permissible operating currents of the brake can be found in *chapter 14.2 Connection: Holding brake [X3]* in the appendix.

Brake functions

The holding brake is enabled when the controller is enabled and the power stage of the servo positioning controller is activated. Holding brakes have switching delays due to their mechanical inertia and the electrical time constant of the control coil. This is taken into consideration by the servo positioning controller. You can parameterize corresponding delays.

.If you want to edit the parameters for controlling the holding brake, open the menu under **Parameters/Device parameters/Brake functions**. The following window will appear:

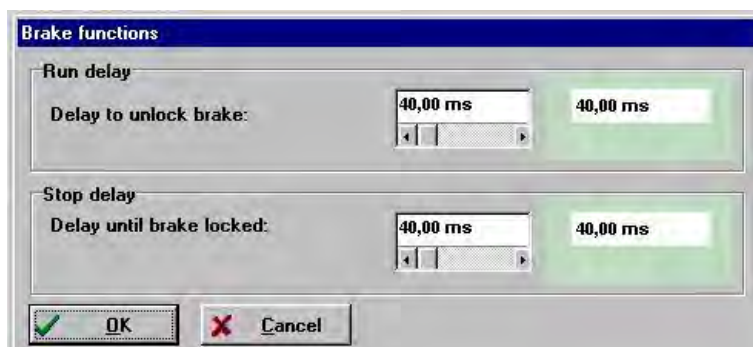

The **run delay** is used to adapt the control of the holding brake to its mechanical inertia. When the controller is enabled in the operating mode "speed control" and "position control" or "positioning", the speed setpoint will be set to zero during this delay. As a result, the motor will be supplied with power, but the drive remains in standstill with a holding torque until the brake is completely unlocked.

When the controller is disabled, the speed setpoint will be set to zero. When the actual speed is about zero, the holding brake is activated. The **stop delay** takes effect as of this point of time. During this time, the drive will be kept in its current position until the holding brake has developed its full holding torque. When the delay period is over, the controller is disabled. In both cases, the mechanical wear of the holding brake is reduced.

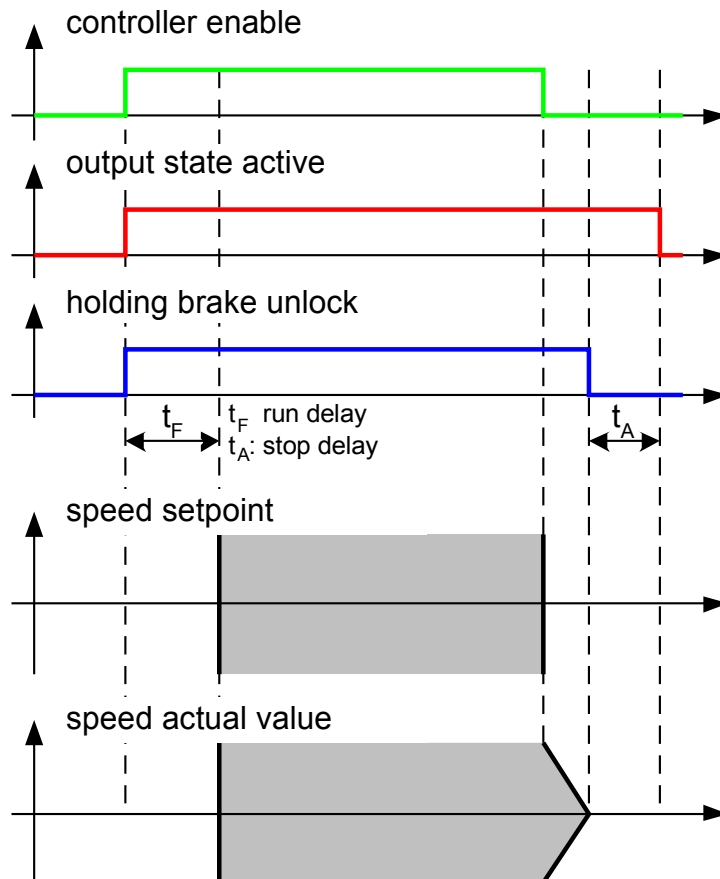

Figure 26: Holding brake time response



After the controller has been enabled, speed setpoints or positioning start commands do not become effective until at the end of the run delay.

In torque control mode, the torque setpoints become active or inactive when the controller is enabled internally.

Analog inputs AIN0 and AIN1

The servo positioning controller has two analog inputs for the input voltage range of ± 10 V. They have a resolution of 12 bits. These inputs can be used flexibly to assign speed and torque setpoints.

If you select **Parameters/IOs/Analog inputs** or click the "..." button in the setpoint selector menu when the analog input is activated, the following menu will be displayed:

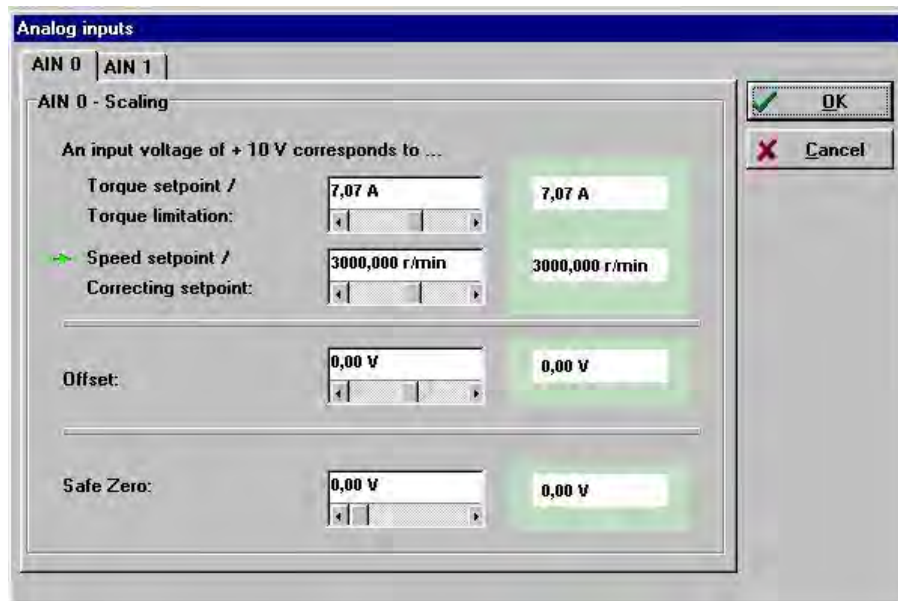

Here you can enter a "conversion factor" between the input voltage and the **torque setpoint** or the **speed setpoint**.

In the **Offset** field, you can enter a voltage that will be automatically added to the voltage measured at the analog input. This can be used, for instance, to compensate for the offset of the analog control voltage of a control system and for the offset of the analog input in the controller. This solves the problem that a very small setpoint is generated when a voltage of 0 V is assigned externally.

Another area of application is the possibility to assign positive and negative setpoints at an input voltage of 0..10 V.

The **"Safe zero"** function limits the setpoint to zero if it lies within the voltage range defined in this field. This makes sure that in the case of a setpoint of 0 V the drives remains at standstill for a long time without drifting away slowly.

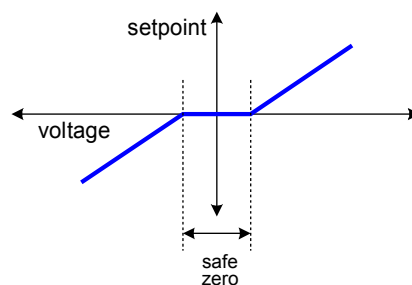

Figure 27: Safe zero



Do not activate the "safe zero" function in the case of applications with a position control (internally or through the external control), as from a control point of view it acts like a dead range or a "backlash" in the control system - see Figure 27. During operation, this downgrades the stability in the control circuit.

This menu has separate tabs for the two analog inputs so that you can scale them independently from each other.

Analog output AMON

The DUET_FL servo positioning controller has an analog output for outputting and displaying internal control variables that can be visualized using an external oscilloscope. The output voltage is in the range of 0 V to +10 V. The resolution is 8 bits.

Select **Parameters/I/Os/Analog outputs** to configure the analog monitor.

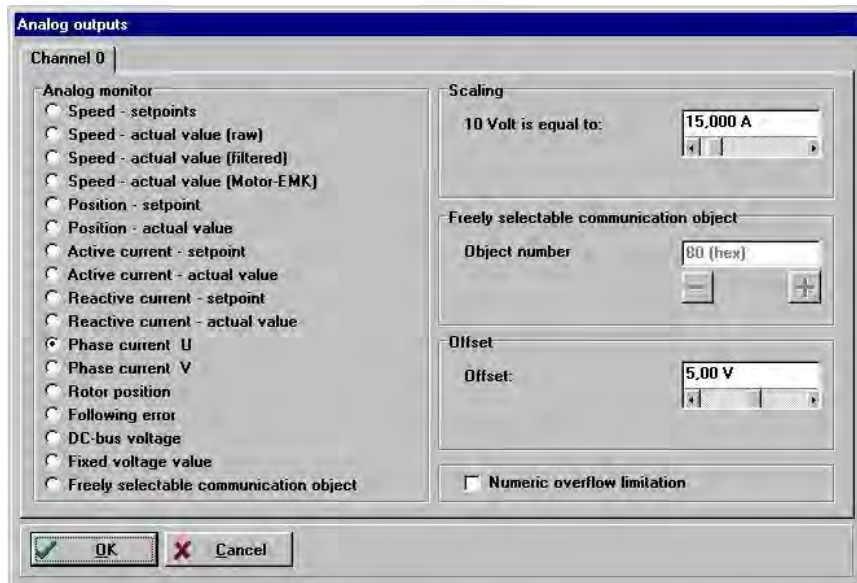

Here, a range of values is available. Select the quantity you want to output through the analog monitor.

Configure the scaling in the **Scaling** field. If you change the quantity to be displayed, the units will be adapted automatically.

In the **Offset** field, you can enter an offset voltage, e.g. to display positive and negative values.

If the check box **Numeric overflow limitation** is selected, mathematical values above +10 V and below 0 V will be restricted to these limits. If the check box is not selected, values exceeding +10 V will be represented as voltages as of 0V and vice versa.



The option **Freely selectable communication object** is reserved for special applications. It is also possible to output and check other internal quantities of the controller to analyze them.

6 Communication interfaces

Control through the CAN bus

Function overview

The DUET_FL servo positioning controller uses the CANopen protocol in accordance with DS301 / DS402.

The following operating modes specified in CANopen are supported:

- ❖ Torque-controlled mode profile torque mode
- ❖ Speed-controlled mode profile velocity mode
- ❖ Homing homing mode
- ❖ Positioning mode profile position mode
- ❖ Synchronous position assignment interpolated position mode

The following access types are supported for the exchange of data:

SDO	Service Data Object	Used for the normal parameterization of the controller. (About 150 SDOs are supported)
PDO	Process Data Object	Rapid exchange of process data (e.g. actual speed) possible. (2 PDOs are supported)
SYNC	Synchronization Message	Synchronization of several CAN nodes.
EMCY	Emergency Message	Transmission of error messages.
NMT	Network Management	Network service: All CAN nodes can be influenced simultaneously, for example.
HEARTBEAT	Error Control Protocol	The communication members are monitored through regular messages.



More information concerning the communication and control of the DUET_FL servo positioning controller via the CANopen interface and information concerning the connection of the CAN bus can be found in the **CANopen manual** for the DUET_FL servo positioning controller.

6.1.1 Processing of CAN messages

The DUET_FL has a command interpreter for the CAN messages received. This command interpreter is activated every 1.6 ms. It can process an SDO or a special message, such as a SYNC telegram or an emergency message, every time it is activated. The processing of PDOs may take two time slices of the command interpreter depending on the complexity. This structure results in restrictions concerning the speed with which the DUET_FL can process the CAN objects.

- The control system must not transmit PDOs more often than every **4 ms**, as otherwise the DUET_FL may not be able to detect or evaluate a PDO. This may cause jumps in the control system or jerking of the motor.
- In the worst case, a PDO does not become effective until after **4.8 ms** (e.g. as a speed setpoint). This happens when two time slices are required to process the PDO and when the PDO is transmitted immediately after the command interpreter is called up.
- Up to **8 ms** may pass between the transmission of an SDO and the response of the controller since the response data have to be compiled in the controller first.



More information concerning the communication and the control of the DUET_FL servo positioning controller via the CANopen interface as well as information concerning the connection of the CAN bus can be found in the **CANopen manual** for the DUET_FL servo positioning controller.

6.1.2 Configuring the CANopen communication parameters

You can adapt the CANopen communication parameters of the DUET_FL servo positioning controller to your CAN bus network under **Parameters/Fieldbus/CANopen**.

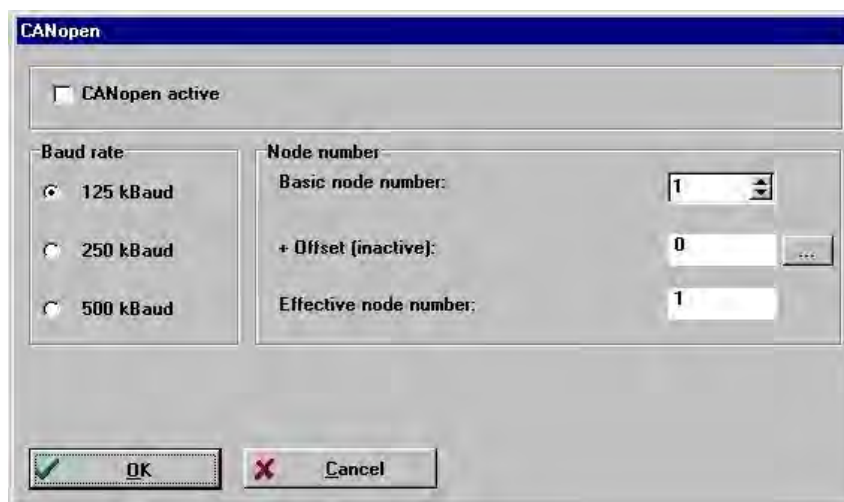

You can define the following communication parameters:

- ❖ **Baud rate:** This parameter determines the baud rate used on the CANopen bus.
- ❖ **Basic node number:** This parameter includes the "basic node number" of the device. This number is used to calculate the "effective" node number. It is possible to include the digital inputs into the calculation of the effective node number (see below).

The identifiers of the messages are based on the node number. A node number may be assigned only once on a CANopen network.

❖ **Addition of DIN0...DIN3 to node number:** The value of the digital inputs DIN0.. DIN3 will be added to the basic node number. The input combination will be read out only when the CANopen interface is activated or directly after a RESET of the DUET_FL servo positioning controller.

Thus, up to 16 different device addresses can be assigned by using simple jumpers connected to 24V at the digital inputs.

If you want to use this function, you must parameterize the digital inputs accordingly (see *chapter Configuring the digital inputs*). Clicking the "..." button opens the menu for configuring the digital inputs.

The **Effective node number** field shows the node number resulting from the basic node number and the offset.

The **CANopen active** check box is used to activate or deactivate the field bus communication with the set parameters. This setting will be adopted straight away, i.e. no reset is required to activate or deactivate the CANopen interface.

Control through the serial interface

Function overview

The DUET_FL servo positioning controller has an asynchronous serial interface. In most cases, this interface is used for the parameterization of the servo positioning controller.

The interface can also be used to control the controller in the application if the response time of the drive is not of prime importance.

In this case, so-called communication objects are used for the communication. There are communication objects used to read out certain quantities such as the current or the speed. Other communication objects are used to read and write parameters.

A communication objects comprises the following values:

- ❖ Permissible minimum setting value
- ❖ Permissible maximum setting value
- ❖ Value set for the parameter
- ❖ Controller-internal value of the parameter



Information concerning the command syntax can be found in *chapter 6.3 Serial communication protocol*. *Chapter List of communication objects* contains a list of all communication objects supported by the system.



The controller-internal value of a parameter may differ slightly from the adjusted value as the servo positioning controller internally uses other units and standardizations than the communication objects.

6.1.3 Serial communication through DUET_FL ServoCommander™

The parameterization program uses the serial interface to communicate with the DUET_FL servo positioning controller.

In the delivery state, the parameterization program assumes the following data:

- ❖ Interface COM1
- ❖ 9600 bauds data transfer rate (factory setting of the servo positioning controllers)
- ❖ 8 data bits, 1 stop bit, no parity check. These settings are fixed!

It uses a certain protocol defining the individual commands. You can find a list of these commands in *chapter 6.3. Serial communication protocol*.

When the program is started, it tries to set up a communication with a servo positioning controller. If it fails, an error message will be displayed. In this case, you have to configure the data for the communication correctly. To do so, you need to know the **serial interface** (COM port number) and the **data transfer rate** used.

Configuring the RS232 communication parameters

You can increase the baud rate based on the **actual data transfer rate** in the menu under **Options/Communication/Baud rate**.

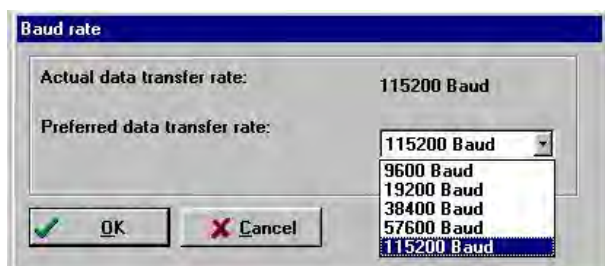

You have to select a **preferred data transfer rate**.

The program tries to set up a communication using the baud rate defined. The preferred transfer rate will either be accepted or set to a lower value. The actual baud rate will be displayed in the field **Actual data transfer rate**.

This baud rate is used for the "normal" online communication with the servo positioning controller. A special baud rate will be selected for downloading the firmware.

Under **Options/Communication/Interface** you can select the interface (COM port) to be used by the parameterization program for the communication with the servo positioning controller:

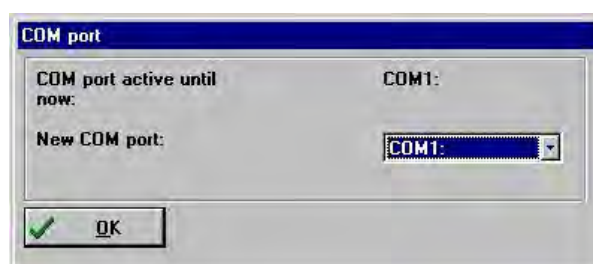

Transfer window

The Transfer window can be used to send commands directly to the DUET_FL servo positioning controller and to observe its response.

Use the menu command **File/Transfer** to activate the Transfer window.



When the Transfer window is active, all other open windows are not served (e.g. actual values, oscilloscope).

Close the Transfer window if you do not need it anymore.

In general, the Transfer window is used to transmit commands which are not of interest for normal operation. In addition, it can be used to read and write storage locations or communication objects. This is only necessary in special cases.

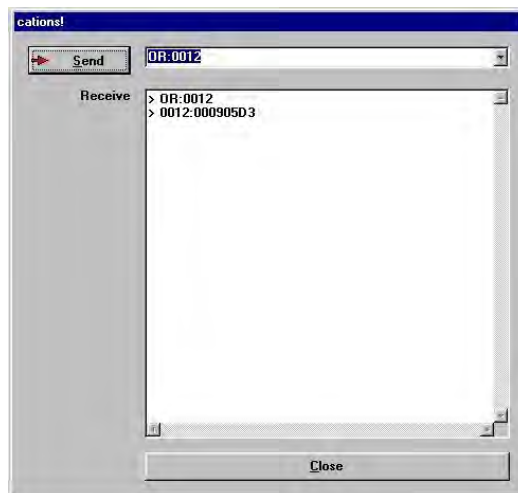

If you want to transmit a command, enter the command in the upper input line and press <ENTER> or click the **Send** button.

Communication window for RS232 transmission

Under **Options/Communication/Display communication window (RS232)** you can open a window in which you can observe the communication through the serial interface. This window is mainly used for debugging and not of interest for "standard users".

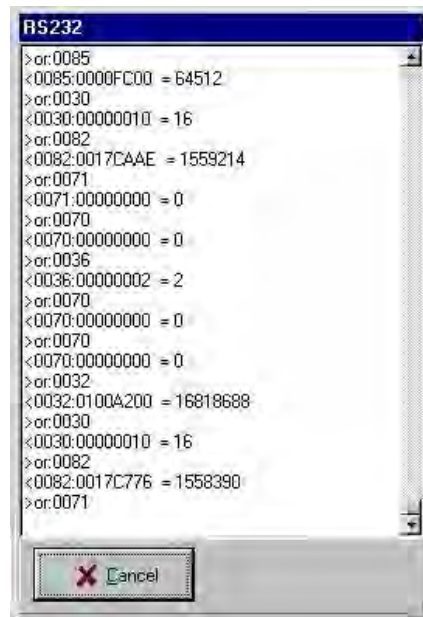

Control through the technology interface

The DUET_FL servo positioning controller has a technology interface which is equipped with a synchronous serial interface.

As a result, customized extension modules / communication interfaces can be implemented.

Please contact your local distributor if you are interested in this option.

Error messages/Error table

Error monitoring in the DUET_FL

The DUET_FL servo positioning controller has an extensive sensor system monitoring the operation of the controller, power output stage, motor and communication with the outside world. Any occurring errors are stored in an internal error memory.

The main monitoring functions are described in the following chapters.



The reaction to the errors can be configured with the help of a comfortable error management system (see *chapter 6.2 Error management*).

6.1.4 Overcurrent and short-circuit monitoring

- ❖ **Overcurrent and short-circuit monitoring:** The overcurrent and short-circuit monitoring system responds as soon as the current in the intermediate circuit (DC bus) exceeds two times the maximum current of the controller. It detects short-circuits between two motor phases and short-circuits at the motor output terminals against the positive reference potential of the intermediate circuit (DC bus). If the error monitoring system detects an overcurrent, the power output stage will be shut down immediately to guarantee resistance against short-circuits.
- ❖ **I²t current monitoring with controller warning:** The DUET_FL servo positioning controller has an I²t monitoring system to limit the average power loss in the power output stage. Since the power loss in the electronic power system and in the motor increases in a square manner with the current in the worst case, the squared current value is taken as the measure for the power loss. When 80% of the maximum integrated value are reached, a warning (parameterizable) will be issued. When 100% is reached, the maximum current will be limited to the rated current.
- ❖ **Current measurement check and offset calibration when the power stage is turned on:** When the power stage is turned on, an automatic offset calibration of the current measurement will be performed. If the offset lies beyond the permissible tolerances, an error will be issued.

DC bus voltage monitoring

- ❖ **Overvoltage monitoring:** The overvoltage monitoring system of the DC bus (intermediate circuit) responds as soon as the DC bus voltage exceeds the operating voltage range. As a result, the power output stage will be shut down.
- ❖ **Undervoltage monitoring:** The system checks whether the intermediate circuit voltage (DC bus voltage) is above a certain minimum limit (see *chapter DC bus monitoring*). For

applications requiring the intermediate circuit to be run "empty" or a set-up mode with a reduced DC bus voltage (intermediate circuit voltage), the response to this error can be configured.

Logic supply monitoring

- ❖ **24V overvoltage / undervoltage monitoring:** The power supply of the logic component of the DUET_FL servo positioning controller is monitored. If the power supply of the logic component is too high or too low, a fault message will be issued.
- ❖ **Internal operating voltages:** All operating voltages generated internally, such as the 3.3 V supply of the processor, are monitored.

Heat sink temperature monitoring

- ❖ **Temperature derating:** The permissible maximum current will be reduced at high temperature levels to ensure a long service life of the servo positioning controller.
- ❖ **Shut-down at overtemperature:** The heat sink temperature of the power stage is measured using a linear temperature sensor. When the temperature limit described in the appendix in *chapter Ambient conditions and qualification* is reached, an error message will be issued. In addition, a temperature warning will be issued when the temperature is about 5°C below the limit value.

Motor monitoring

- ❖ **Rotary encoder monitoring:** An error in the rotary encoder shuts down the power output stage. In the case of resolvers, the track signal is measured, for example. In the case of incremental encoders, the commutation signals are checked. Other "intelligent" encoders have other means of error detection.
- ❖ **Motor temperature measurement and monitoring:** The DUET_FL servo positioning controller has an analog input for detecting and monitoring the motor temperature. Due to the analog signal detection, also non-linear sensors are supported. The shut-down temperature can be parameterized. Alternatively, the motor temperature can also be monitored with the help of a normally-closed contact or a PTC. In this case, however, the shut-down threshold cannot be parameterized.
- ❖ **I²t current monitoring with motor warning:** The DUET_FL servo positioning controller also has an I²t monitoring system to limit the average power loss in the motor. Since the power loss in the electronic power system and in the motor increases in a square manner with the current in the worst case, the squared current value is taken as the measure for the power loss. When 80% of the maximum integrated value are reached, a warning (parameterizable) will be issued. When 100% is reached, the maximum current will be limited to the rated current.
- ❖ **Automatic motor identification process monitoring:** The system monitors whether the automatic identification of the phase sequence, the number of pairs of poles and the angle encoder offset has been performed successfully.

Motion sequence monitoring

- ❖ **Following error:** The deviation between the position setpoint and the actual position is monitored.
- ❖ **Positioning range:** A running positioning run is monitored to see whether the positions are within the adjustable positioning range.
- ❖ **Limit switches:** If both limit switches are simultaneously active, an error will be issued.
- ❖ **Course program:** The course program is monitored to detect invalid commands.

Additional internal monitoring functions

- ❖ **Memory test / check sums:** The internal FLASH memory (program and data flash memory) is monitored with the help of a check sum test and the processor stack is also monitored.
- ❖ **Operating mode:** Depending on the operating mode, specific monitoring functions are activated.
- ❖ **Communication:** The communication through the serial interface and through the field bus (CANopen) is monitored.

Operating hour meter

The DUET_FL servo positioning controller has an operating hour meter. In the DUET_FL ServoCommander™ parameterization software, it is displayed on the **Times** tab in the **Info/Info** menu.

The count of the operating hour meter is saved in the internal flash once in a minute. As a result, there may be deviations of up to 60 seconds after a reset or a power-on.

Error overview

The following table provides an overview of all possible errors.

In the **Reaction** column, the reactions you can parameterize are marked with an "X".



The parameterization of the possible errors is described in *chapter 6.2 Error management!*

The abbreviations **C**, **E** and **W** have the following meaning:

- ❖ **Critical error:** The controlled operation of the motor cannot be guaranteed. The power stage will be switched off immediately. The motor will coast down.
- ❖ **Error:** The motor will be decelerated with the safety ramp. Then the power stage will be switched off.
- ❖ **Warning:** The motor can still be used though perhaps only for a limited amount of time. The user can parameterize whether warning will be displayed or not:

- Display: The error will be displayed but no other measures are taken.
- No display: The error will be ignored completely.

Table 16: Error overview

Error no.	CAN error code	Meaning	Possible causes / measures	Release time	Reaction		
					C	E	W
3	4310	Motor overtemperature	Check the configuration of the temperature monitoring system. Temperature sensor correctly wired? Movement of mechanical system impaired, motor too hot?	< 100ms	X	X	X
4	4210	Over-/ undertemperature power stage	Temperature of the electronic power system < -40°C or > 85°C. DUET_FL heated up by the motor? Decouple the DUET_FL thermally if necessary. Check / improve the installation and the cooling conditions.	< 100ms	X	X	
5	7392	Error SINCOS supply	Angle encoder connected? Angle encoder cable defective? Angle encoder defective? Check the configuration of the angle encoder interface.	< 5ms	X		
6	7391	Error SINCOS RS485 communication	Angle encoder connected? Angle encoder cable defective? Angle encoder defective? Check the configuration of the angle encoder interface. New or unknown SINCOS encoder?	< 5ms	X		
7	7390	Error of track signals of SINCOS encoder	Angle encoder connected? Angle encoder cable defective? Angle encoder defective? Check the configuration of the angle encoder interface.	< 5ms	X		
8	7380	Error of resolver track signals / carrier failure	Resolver connected? Angle encoder cable defective? Angle encoder defective? Check the configuration of the angle encoder interface.	< 5ms	X		
9	5113	Error 5V - internal supply	The error may be due to a defective angle encoder, due to defective Hall sensors or due to a wiring error of X2. Possible error on technology module X8 Electronic error in the DUET_FL device. The error cannot be eliminated by the user. Send the servo positioning controller to the distributor.	< 5ms	X		
10	5114	Error 12V - internal supply	The error may be due to a defective angle encoder, due to defective SINCOS encoder or due to a wiring error of X2. Electronic error in the DUET_FL device. The error cannot be eliminated by the user.	< 5ms	X		

Error no.	CAN error code	Meaning	Possible causes / measures	Release time	Reaction		
					C	E	W
			Send the servo positioning controller to the distributor.				
11	5112	Error 24V supply (out of range)	24 V logic supply too high or too low? 24 V logic supply cannot be loaded, e.g. when the holding brake is actuated? Error in the holding brake or in the wiring to X3 or overload of the brake output due to a brake with a too high current consumption. Electronic error in the DUET_FL device. The error cannot be eliminated by the user. Send the servo positioning controller to the distributor.	< 5ms	X		
13	5210	Error offset current metering	The error cannot be eliminated by the user. Send the servo positioning controller to the distributor.	< 5ms	X		
14	2320	DC bus overcurrent / output stage	Motor defective, e.g. winding overloaded and burnt, short-circuit between winding and housing? Short-circuit in the cable between two phases or between a phase and the shield? Insulation of motor phase connections? Defect inside DUET_FL (output stage defective or insulation fault - insulating foil)	< 10µs	X		
15	3220	DC bus undervoltage	DC bus (intermediate circuit) supply too low? DC bus (intermediate circuit) supply cannot be loaded sufficiently, e.g. during acceleration with full current? Check the configuration of the DC bus (intermediate circuit) monitoring system. If necessary, set to 70% to 50% of the rated voltage.	< 1ms	X	X	X
16	3210	DC bus overvoltage	DC bus (intermediate circuit) voltage > 70 V. DC bus (intermediate circuit) supply too high during idling? Check rating. Brake energy too high when axes are decelerated. Capacity in DC bus (intermediate circuit) too low. Install an additional capacitor (approx. 10,000 µF / per 10 A motor current)	< 1ms	X		
17	7385	Error Hall encoder	Angle encoder connected? Angle encoder cable defective? Angle encoder defective? Check the configuration of the angle encoder interface.	< 5ms	X		
19	2312	I ² t error motor (I ² t at 100%)	Angle encoder, number of pairs of poles and direction adjusted correctly - Automatic motor identification performed? Motor blocked?	< 100ms	X	X	X

Error no.	CAN error code	Meaning	Possible causes / measures	Release time	Reaction		
					C	E	W
			Check the power rating of the drive package.				
20	2311	I ² t error controller (I ² t at 100%)	See error 19.	< 100ms	X	X	X
26	2380	I ² t at 80%	Motor blocked? Check the power rating of the drive package.	< 100ms	X	X	X
27	4380	Motor temperature 5°C below maximum	Check the power rating of the drive package.	< 100ms	X	X	X
28	4280	Output stage temperature 5°C below maximum	Check the power rating of the drive package. DUET_FL heated up by the motor? Decouple the DUET_FL thermally if necessary. Check / improve the installation and the cooling conditions.	< 100ms	X	X	X
29	8611	Following error control	Motor blocked? Controller adjusted optimally, particularly the internal control circuits for current and speed? Acceleration parameterization too high? Error window too small. Increase the window.	< 5ms	X	X	X
31	8612	Error limit switch	Limit switch correctly wired? Limit switch defective? Check the configuration of the limit switches.	< 1ms	X	X	X
35	6199	Timeout: Quick stop	Has an angle encoder error occurred? Motor identification not performed successfully? Acceleration parameterization too high?	< 5ms	X		
36	8A80	Error during homing run	Homing run could not be completed successfully. Check the configuration of the homing run. Parameterization of the controller including the angle encoder configuration OK?	< 5ms	X	X	X
40	6197	Error: Motor and resolver identification	Angle encoder connected? Angle encoder cable defective? Angle encoder defective? Check the configuration of the angle encoder interface.	< 5ms	X		
43	6193	Course program: unknown command	Please contact the technical support team.	< 5ms	X	X	
44	6192	Course program: invalid branch destination	The digital inputs for START1 & START2 are set simultaneously. An invalid branch destination / an invalid target position will be addressed.	< 5ms	X	X	
55	8100	CAN communication	Communication disturbed: Check the installation under EMC aspects.	< 5ms	X	X	X

Error no.	CAN error code	Meaning	Possible causes / measures	Release time	Reaction		
					C	E	W
		error	Check the baud rate setting Check the node number setting - node used more than once in the network?				
56	7510	RS232 communication error	Communication disturbed: Check the installation under EMC aspects.	< 5ms	X	X	X
57	6191	Error position data set	Conflict between acceleration and running speed. Please contact the technical support team.	< 5ms	X		
58	6380	Error: Operating mode	Change of operating mode while the power stage is switched on.	< 5ms	X	X	X
60	6190	Error: Pos. precomputation	Internal error. Please contact the technical support team.	< 5ms	X		
62	6180	Stack overflow	Internal error. Please contact the technical support team.	< 5ms	X		
63	5581	Check sum error	Internal error. Please contact the technical support team.	< 5ms	X		
64	6187	Initialization error	Internal error. Please contact the technical support team.	< 5ms	X		



The servo positioning controller internally manages the error no. 1 to no. 64.

If your device displays an error number which is not described in the error table and marked as an "unknown error" in *chapter 6.2 Error management*, please contact your local distributor.

It is possible to assign these error numbers for firmware extensions or customized firmware versions with additional monitoring functions.

Error display in DUET_FL ServoCommander™

The **error window** is a permanent window in the parameterization program. If there is no error, the window is minimized.

In the event of a controller error, the user interface changes in two ways:

1. The error window will be maximized and put to the surface.
2. The error will be stated in red writing on the lower bar of the main window.



08: Error of resolver track signals /carrier failure 16:55:20

Errors are handled in three steps:

1. **Error analysis:** In the example given here, the error is caused by a broken/unconnected connection to the angle encoder.
2. **Error elimination:** Eliminate the cause of the error. (In this example, the correct connection to the angle encoder has to be provided.)
3. **Error acknowledgement:** Click on the **Clear** button in the error window. If the error was successfully eliminated, the window will be minimized. If the error still exists, it will be maximized again.

You can minimize the window by clicking the **Cancel** button. Any existing error message will remain in the error window on the status bar.



The **Cancel** button does not eliminate any error!

6.2 Error management

The error management window and the error window are used for error messages and warnings.

You can open the error management window under **Error/Error management**:



You can use this window to define the way the servo positioning controller should respond to an error. One of four reaction types is assigned to each of these 64 possible events.

1. The power stage will be switched off (the motor will coast down).
2. Controlled shut-down (the motor will be decelerated to standstill in a controlled manner).
3. A warning will be displayed (the error window will be opened automatically).
4. A warning will not be displayed (i.e. a warning messages will be entered into the error window but the error window will not be opened automatically).

Some of the events are so serious that the user cannot downgrade them to warning or that a certain reaction is inevitable. In these cases, the user can select the option button but the servo positioning controller will correct this entry during the online parameterization.

Appendix

DUET_FL ServoCommander™ operating instructions

Standard buttons

If a program window is open while you are working, this window will have a button bar which often looks like this:



The buttons have the following functions:

- OK:** All changes will be accepted and the window will be closed.
Cancel: All changes will be undone and even already transferred values will be restored and the window will be closed.

You can actuate a button in the following ways:

- Click it with the left mouse button.
- Press the **TAB** key to activate the button and then press the **ENTER** key to confirm.
- Use the keyboard and press the underline letter key together with the **ALT** key.

If the appearance of the buttons in some menus differs from the form described here, you will find more detailed information in this manual.

Numerical input fields

In the windows of the parameterization program you will always find fields for numerical entries as shown below:



Entries can be made in the following ways:

1. Directly using the keyboard: Enter the value directly into the entry line. As long as the entry is not complete, the text will be shown in thin print and will not be transferred to the parameterization program yet (see the illustration).



At the end of the entry, press the ENTER key or switch to another input field using the TAB key. The numerical value will then be shown in bold print.





2. Clicking the arrow keys: The value changes in small steps (fine adjustment).
3. Clicking the areas between the grey boxes and the arrow keys: The value changes is large steps (rough adjustment).
4. Clicking the grey box and moving the mouse with the left mouse key pressed down: The value can easily be preset over the entire value range.

Control elements

The user is guided preferably with the help of graphically oriented windows.

The following table shows and describes the control elements used in the windows:

Table 17: Control elements

Control element	Name	Description
	Check box	An option, which the user can activate or deactivate by checking the corresponding check box. It is possible to check several boxes at once.
	Radio button	With this button, the user can choose one of several options.
	"..." button	A button, which opens another menu when clicked by the user.
	General button	A button, which opens another menu when clicked by the user.

6.2.1 Display of setpoints and actual values

The parameterization program creates the setpoints, which correspond to a desired user input, and the actual values used in the device in accordance with the following concept.

1. The user changes the scroll box in the window by moving the scroll bar or by entering a new value.
2. The parameterization program transmits the value to the DUET_FL servo positioning controller.
3. The parameterization program immediately reads out the now valid parameter and displays it in the green field. The scroll box itself remains unchanged.



Definition of terms:

- ❖ **Setpoint value:** The setpoint value (value desired by the user) transmitted to the DUET_FL servo positioning controller
- ❖ **Actual value:** This value is currently active in the DUET_FL servo positioning controller. Deviations from the setpoint value may have several reasons.
Examples:
 - Quantization effects, rounding effects, etc.
 - The changed parameter has to be saved and a RESET has to be performed in order to make the parameter effective.
 - Temporary value range overshoots, e.g. rated current > maximum current
 - Incorrect value ranges, e.g. when loading a parameter set of a servo positioning controller of a higher class of performance (rated current > rated device current)



The idea behind the concept of different setpoints and actual values is the following: A parameter set can be loaded from a servo positioning controller of one class of performance to a servo positioning controller of another class of performance and vice versa. As long as no other parameterization has been performed, the setpoints remain **unchanged**. Only the actual values will be different due to the different class of performance. This prevents a step-by-step change of a parameter set resulting from the device's class of performance.

6.2.2 Standard window

In the default configuration, the commands window, the status window and the actual value window are open during the online parameterization. During the offline parameterization, the status window and the actual value window are not open.

The **Actual values** window displays the current controller parameters such as currents, speeds, etc. The Actual values window is configured under **Display/Actual values**. The check boxes of all values to be displayed must be checked. With the options **Enable all** or **Disable all**, the **Actual values** window can be quickly minimized or maximized.

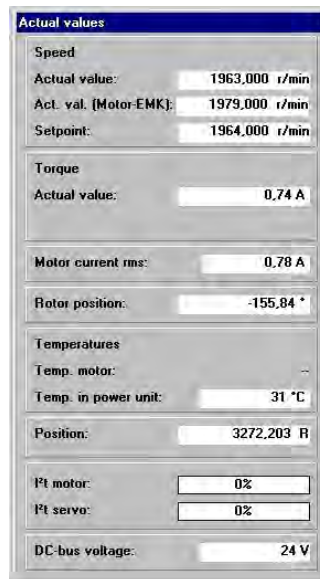

Directories

The installed version of the parametrization program has the following sub-directories:

Table 18: Directories

Directory	Content
FIRMWARE	Firmware versions
TXT	Default directory for plain text output of parameter data
DCO	Default directory for the parameter files

6.2.3 Communication via communication objects

The parametrization program accesses the DUET_FL servo positioning controller by means of so-called communication objects via a standardized, internal software interface. During the processing of the communication tasks, an internal check for the following errors will be performed:

- ❖ Write access to read-only communication objects
- ❖ Read access to write-only communication objects
- ❖ Overshooting or undershooting of the values range
- ❖ Erroneous data transfer

The first two cases are fatal errors, which normally should not occur in practice. In the last case, the parameterization program repeatedly tries to perform the read or write process without a bit error.

Overshooting and undershooting of the value range of a communication object are indicated by a warning. If there is an internal value for this object, the value will be saved as a desired value. However, the original value will be maintained internally. Otherwise the value will be rejected.

Quitting the program

The program can be quit as follows:

- ❖ Select the menu option **File/Exit**.
- ❖ Press the shortcut **<Alt>+F4**
- ❖ Click the X button on the upper left-hand side of the main window.

Setting up the serial communication

You have to perform the following steps to configure the data for the communication:

1. Connect the DUET_FL servo positioning controller completely.
2. Connect a free port of the PC with the DUET_FL servo positioning controller using null modem cable.
3. Switch the DUET_FL servo positioning controller on.
4. Start the parameterization program.

If the Online button in the toolbar is displayed in green (see illustration), the communication parameters are already set correctly.



If the parameterization program cannot open the serial interface, the following error window will be displayed when the program is started:

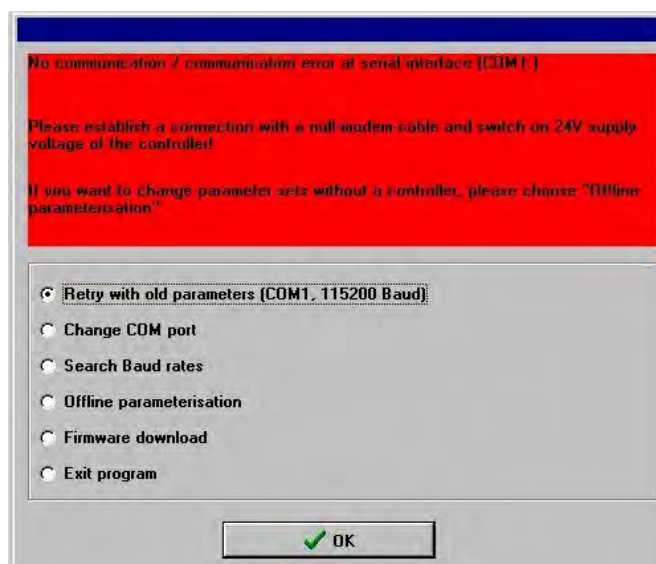

This error can be due either to a wrong interface setting (mostly mouse driver setting) or another Windows® or MS-DOS® program accessing the serial interface.

To solve this access conflict, close the other program (in the case of MS-DOS®-based programs also close the MS-DOS® shell!) and click the button **Retry with old parameters**. To correct the interface configuration, click on the radio button **Change COM-port** and following the instructions (see *chapter Configuring the RS232 communication parameters*).

The servo positioning controller may use another baud rate than the one set in the parameterization program. If you select **Search baud rates**, the parameterization program will try out all kinds of baud rates to set up a communication.

Use the **Offline-parameterisation** option only if you want to work on parameter set files without a servo positioning controller. See also *chapter Offline parameterization*.

If the servo positioning controller has no valid firmware or if you want to download the firmware, you can initiate this by selecting the **Firmware download** option.

Clicking the radio button **Exit program** immediately terminates the parameterization program.

The following table describes possible error causes the error elimination strategies:

Table 19: Recovering problems with serial communication

Cause	Measure
Communication error	Click on Retry with old parameters .
Wrong COM-port selected	Click on Change COM-port and follow the instructions.
The baud rate of the parameterization program does not match the baud rate of the servo positioning controller.	Click on Search baud rates .
The communication of the servo positioning controller is disturbed.	RESET the servo positioning controller, i.e. switch it off and on again. Then click on Retry with old parameters .
<u>Hardware error:</u> ❖ Servo positioning controller not switched on ❖ Connecting cable disconnected ❖ Connecting cable broken ❖ Incorrect pin assignment for the serial connection	Eliminate the error and then click on Retry with old parameters .
❖ Connecting cable too long	Reduce the baud rate or use a shorter cable.

Info window You can call up general information concerning the DUET_FL ServoCommander™ under **Info/Info**. The following window will appear:



You can find the following information on the **Copyright** tab:

- ❖ Program name, version
- ❖ Sales partner: Address and phone number
- ❖ Internet link: Click on the button to activate it.
- ❖ Email address: Click on the button to create an e-mail.

You can find the following information on the **Firmware/Hardware** tab:

- ❖ Main board: Type, serial number, version
- ❖ Bootloader: Version
- ❖ Firmware: Version

You can find the following information on the **Communication** tab:



- ❖ COM port and baud rate used (online parametrization)
- ❖ File used (offline parametrization)

The **Times** tab gives you information concerning the cycle times of the following components:

- ❖ Current controller
- ❖ Speed controller
- ❖ Position controller
- ❖ The current count of the operating hour meter.

Fast access via the tool bar

Some functions of the parametrization program can be accessed directly using the icons beneath the menu bar:

Icon	Meaning
	<p>Oscilloscope</p> <p>Offline parameterization</p> <p>Online parameterization</p> <p>Search for communication</p> <p>Set French language</p> <p>Set English language</p> <p>Set German language</p>
	<p>Reset servo positioning controller</p> <p>Save parameters</p> <p>Approach positions</p> <p>Set positions</p> <p>Homing</p> <p>Position controller</p> <p>Speed controller</p> <p>Current controller</p> <p>Motor data menu</p>

Using the oscilloscope function

The oscilloscope function integrated in the parameterization program allows signal courses and digital statuses to be represented and physical parameters to be optimized.

The graphs, e.g. step responses, can be printed, saved as bitmaps or exported into Microsoft® Excel.

The oscilloscope can be started under Display/Oscilloscope or with the help of the  button.

Two windows will open: the actual oscilloscope and the window for configuring the oscilloscope.

Oscilloscope settings



The **Oscilloscope - Settings** window includes four tabs for precise settings.

- ❖ **Ch1:** Selection of the measuring quantity on channel 1
- ❖ **Ch2:** Selection of the measuring quantity on channel 2
- ❖ **Time base:** Setting of the time base
- ❖ **Trigger:** Configuration of the trigger

The oscilloscope has two channels. The following settings can be selected on the tabs **CH1** and **CH2** for the corresponding channels:

- ❖ Quantity to be displayed. Click on the **scroll box** of the channel and select the physical quantity or the event you would like to display graphically.

- ❖ Channel colour. Click on the coloured screen area. A dialog box for selecting a colour will be displayed.
- ❖ Y-Scaling. Use the slide next to **Scaling** to adjust the scaling in vertical direction.
- ❖ Offset / Y-Position. Use the slide next to **Offset** to shift the vertical position of the curve. Clicking the **0** button resets the offset to 0.

The representation of the two channels can be cleared by clicking on the **Clear** button.

If **Freely selectable communication object** has been selected as the quantity to be displayed, you can display any desired communication object on the oscilloscope. This requires the following additional information:

- ❖ The object number of the communication object
- ❖ Information as to whether the object returns a value with a sign. In this case please check the **signed** check box.
- ❖ The physical unit of the object
- ❖ A mask. This mask is used to single out and display individual bits of a communication object. In the case of analog values, this mask should be set to FFFFFFFF (hex). The main purpose of this mask is to display individual bits of a status word.



The representation of freely selectable communication objects makes sense only in special cases.

The time resolution and the recording delay can be configured on the **Time base** tab:

- ❖ The upper **Time** slide is used to define the time resolution. A value of 10 msec/div, for example, means that the width of one square on the oscilloscope display corresponds to a time of 10 milliseconds.
- ❖ The **Delay** slide is used to determine the position of the trigger event on the oscilloscope screen. A value of 0 means that the trigger event will be plotted at the left edge of the oscilloscope screen. A negative delay value means that the events before the occurrence of the trigger conditions will also be recorded ("Pretrigger").



The trigger source can be selected from the list in the **Trigger source** field on the **Trigger** tab.

Just like CH1 and CH2, the trigger event can be selected from a list of predefined standard events. Alternatively, you can also select **Freely selectable communication object** and use any communication object for triggering.

A distinction is made between **digital** and **analog** trigger sources. Digital trigger sources can only have the status yes or no (active or inactive). An example is DI7 limit switch 0. Analog trigger sources on the other hand can take on any numerical value (e.g. actual speed value).

In the case of analog trigger sources, a scroll box for the **trigger level** will be displayed. The trigger process starts when the analog value has exceeded or fallen below the level.

The trigger edge can be used to define when the system should react to an event:

	Rising edge	Digital trigger: Event occurs Analog trigger: Level exceeded
	Falling edge	Digital trigger: Event disappears Analog trigger: Below level



The trigger mode and the therefore the oscilloscope are only active if the **Run / Stop** check box in the oscilloscope window is selected!

When you open the Transfer window or save the parameter set, the oscilloscope will be deactivated. This is why the check box has to be deselected and reselected afterwards to reactivate the oscilloscope.







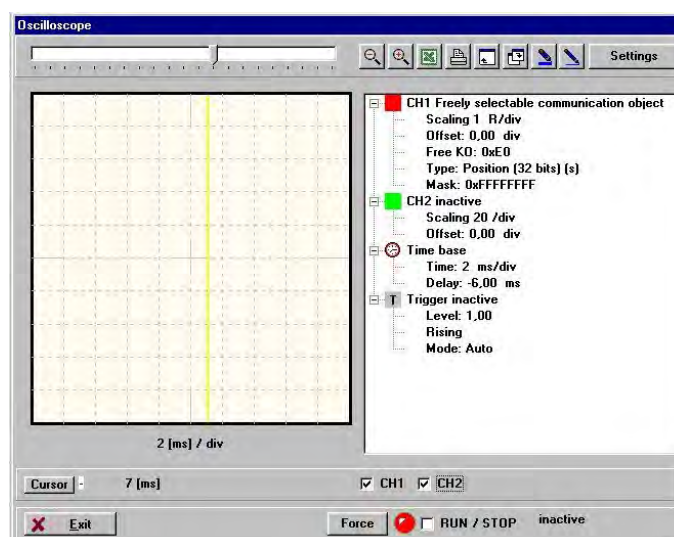

The **Mode** field is used to select when triggering should occur. There are three different trigger modes:

- ❖ **Auto:** Triggering occurs and is displayed continuously regardless of whether the trigger condition has been fulfilled or not.
- ❖ **Normal:** Triggering occurs and is displayed when the trigger condition is fulfilled. After the display and if the trigger condition reappears, triggering occurs again.
- ❖ **Single:** It is triggered only once when the trigger conditions has been fulfilled. Then the status is set to inactive by deselecting the **Run** check box (see below).

Oscilloscope window







The oscilloscope has various buttons to start certain activities. They are shown in the following section:

Icon	Meaning
	Calls up the "Oscilloscope-Settings" window.
	Uses thin lines on the oscilloscope display.
	Uses thick lines on the oscilloscope display.
	Maximizes the oscilloscope window
	Minimizes the oscilloscope window
	Prints the oscilloscope window
	Calls up Excel and creates a spreadsheet containing the measurement values of the last measurement (Excel has to be installed on the PC)
	Zoom function: Help text
	Stops the zoom function

	Shifts the area shown in the horizontal direction
---	---

Additional buttons and controls:

Icon	Meaning
	(1)
	(2)
	(3)
	(4)
	(5)

-
- (1) These controls are used to control and visualize the cursor of the oscilloscope. When the user opens the actual oscilloscope window, the current value of the selected channel (cursor position) is displayed in a numerical form. In this example, channel **CH2** has the value **451 r/min** at the time **t=30 ms**. The **Cursor** button can be used to switch to another channel.
 - (2) These check boxes are used to show and hide the channels in a selective manner. A selected check box means: This channel is shown.
 - (3) This coloured area indicates the current status of the oscilloscope. The following entries are possible:

inactive	The oscilloscope is not active at present.
start	The oscilloscope is started.
wait for trigger	The system waits for the trigger event.
pretrigger	The system has started to record data for the pretrigger.
trigger found	A trigger event has been found but the system has not started to record data yet.
data read	The channel data are transferred to the parameterization program.
 - (4) The LED indicates the current operating status of the oscilloscope.
A green LED means: The oscilloscope is active.
An inactive oscilloscope is indicated by a red LED.

The **RUN / STOP** check box is used to activate or deactivate the oscilloscope. Activate the oscilloscope if you want to use it.
 - (5) This button can be used to trigger a trigger event manually. The oscilloscope starts recording data straight away.

6.3 Serial communication protocol

A serial communication protocol in the ASCII format is used for the communication between the DUET_FL servo positioning controller and the DUET_FL ServoCommander™ parameterization program interface. A command always has to be terminated by <CR>.

The technical data of the serial interface are described in *chapter 6.1.3 Serial communication through DUET_FL ServoCommander™*.

So-called communication objects are used mainly for the communication.

You can access the actual values and parameters of the servo positioning controller using these communication objects. Physical quantities are transferred in standardized basic units. The following table shows the command syntax of the communication objects:

Table 20: Command syntax of communication objects

Command	Response	Description
Write object: OW:NNNN:DDDDDDDD	OK! or OW:FFFF FFFF	In the error-free case, "OK!" will be returned. In the case of an error, the command and an error code will be transmitted.
Read object: OR:NNNN	NNNN:DDDDDDDD or OR:FFFF FFFF	Always 32 bits as the reply. In the case of an error, the command and an error code will be transmitted.
Read internal value: OI:NNNN	NNNN:DDDDDDDD or OI:FFFF FFFF	Always 32 bits as the reply. In the case of an error, the command and an error code will be transmitted.
Read minimum value: ON:NNNN	NNNN:DDDDDDDD or ON:FFFF FFFF	Always 32 bits as the reply. In the case of an error, the command and an error code will be transmitted.
Read maximum value: OX:NNNN	NNNN:DDDDDDDD or OX:FFFF FFFF	Always 32 bits as the reply. In the case of an error, the command and an error code will be transmitted.

Table 21: Meaning of letters in the command syntax

Letter	Meaning (hexadecimal)
NNNN	Communication object number
DD...D	Data bytes
FF...F	Error code
	0x00000002 Data value too low > not written
	0x00000003 Data value too high > not written
	0x00000004 Data value too low > written but limited beforehand
	0x00000005 Data value too high > written but limited beforehand
	0x00000008 Bit constant value not permissible
	0x00000009 Bit data value not permissible at present (in this operating mode)
	0x00000010 Read or write error in flash memory
	0x00020000 Lower object limit does not exist
	0x00030000 Upper object limit does not exist

0x00040000	No object present with this number (object does not exist)
0x00050000	Not allowed to write object

In addition to the commands for accessing the communication objects, there are also some commands for controlling the servo positioning controller.

The following table shows the command set used:

Table 22: RS232 command syntax

Command	Response	Description
BAUDbbbb	OK!	Set baud rate
BOOT?	SERVICE / APPLICATION	Status inquiry: Bootloader active?
BUS?	xxxx:BUS:nn:bbbb:mmmm	CAN bus status
INIT!	Turn-on message	Load default parameter set
RESET!	Turn-on message	Cause HW reset
SQT+	xxxx:CQT+	Clear error memory
SAVE!	DONE	Save parameter set in FLASH
SEP!	DONE	Load parameter set from FLASH
TYP?	TYP:dddd	Type inquiry
VERSION?	xxxx:VERSION:dddd	Version inquiry
=iiii:ss:dd..	=iiii:ss:dd..	Simulation SDO write access
?iiii:ss	=iiii:ss:dd..	Simulation SDO read access
	ERROR!	Unknown command / error

Table 23: Meaning of letters in the command syntax

Letter	Meaning (hexadecimal)
xxxx	Status message
dddd	Data bytes
nn	Node number
bbbb	Baud rate
mmmm	Mode
iiii	Index of CANopen SDOobject
ss	Subindex of CANopen SDOobject

List of communication objects

This chapter describes the communication objects used by the DUET_FL ServoCommander™ parameterization interface to exchange data with the DUET_FL servo positioning controller.

A list of the basic units used for the communication objects can be found in *chapter Basic units*.

Table 24: List of all communication objects

No.	Name	Meaning	Scaling
0000	curr_cyc_time_curr	Current controller cycle time	Basic unit time
0001	curr_cyc_time_spdc	Speed controller cycle time	Basic unit time
0002	curr_cyc_time_posc	Position controller cycle time	Basic unit time
0003	main_abtast_ablauf	Communication handler cycle time	Basic unit time
0004	ioh_uzk_nenn	Rated DC bus voltage of the controller	Basic unit voltage
0005	curr_i_nom_dev	Rated device current (peak value)	Basic unit current
0006	curr_i_max_dev	Maximum device current (peak value)	Basic unit current
0007	ofo_uzk_min	Minimum DC bus voltage of the controller	Basic unit voltage
0010	srvc_device_type	Device ID	none
0011	main_cpu_time_remaining	Control interrupt utilization	Basic unit per cent
0012	srvc_operation_time	Operating hour meter	in seconds
0013	srvc_commiss_state	Commissioning state	none
0014	srvc_device_serial_num	Serial number of the device	none
0015	srvc_device_revision	Hardware revision	Upper 16 bits: Main revision Lower 16 bits: Subrevision
0016	srvc_encoder_type	Selected angle encoder variant	Upper 16 bits: Main revision Lower 16 bits: Subrevision
0017	srvc_soft_main	Firmware main revision and subrevision number of the version management system	Upper 16 bits: Main revision Lower 16 bits: Subrevision
0018	srvc_custom_main	Customer application number Subrevision number	Upper 16 bits: Main revision Lower 16 bits: Subrevision
0019	main_bootloader_version	Main revision and subrevision of the boot loader	Upper 16 bits: Main revision Lower 16 bits: Subrevision
001A	srvc_motid_ctrl	Control word for angle encoder identification	0: Reset identification 1: Identify angle encoder
001B	srvc_u_nenn_mot	Rated motor voltage	Basic unit voltage
001C	curr_i_nom	Rated current (peak value) of the motor	Basic unit current
001D	curr_i_max	Maximum current (peak value) of the motor	Basic unit current
001E	curr_iit_mot_time	I ² t integration time for the motor	Basic unit time
001F	srvc_torque_const	Torque constant	Basic unit torque constant
0020	srvc_nenn_mot_speed	Rated motor speed	Basic unit speed
0021	spdc_n_ref_lim_pos	Speed setpoint limitation	Basic unit speed
0022	eeval_enc_polp_num	Number of pairs of poles of the encoder system (motor)	Number of pairs of poles, not number of poles!
0023	ioh_l_mot	Inductivity of the Ls winding of the motor	Basic unit inductivity
0024	ioh_r_mot	Resistance of the Rs winding of the motor	Basic unit resistance
0025	ioh_mot_temp_max	Maximum motor temperature	Basic unit temperature

No .	Name	Meaning	Scaling
0026	srvc_soft_prod_step	Firmware main revision and subrevision number	Upper 16 bits: Main revision Lower 16 bits: Subrevision
0030	seqc_opmode	Parameterization of operating mode and ramp	none
0031	stat_conf2_1	Configuration words of the drive	none
0032	rs232_stat_sum	Status word of the status window	none
0033	seqc_brake_unlock_time	Delay for unlocking the holding brake	Basic unit time
0034	seqc_brake_lock_time	Delay for locking the holding brake	Basic unit time
0035	seqc_auto_brake_time	Minimum waiting time until the brake responds. Not supported at present.	Basic unit time
0036	commh_ctrlenab_log	Parameter describes the component enabling the controller.	0: Only DIN9 1: DIN9 and RS232 2: DIN9 and CAN
0040	commh_null	Auxiliary object that always returns zero	none
0050	rs232_baudrate	Baud rate for the RS232 communication	RS232 baud rate
0051	rs232_para_conf	Configuration word for parameterization software	none
0052	rs232_unit_x_var_i	Physical units position	none
0053	rs232_unit_x_conv_i	Physical units position	none
0054	rs232_unit_x_numerator	Factor group position numerator	none
0055	rs232_unit_x_divisor	Factor group position denominator	none
0056	rs232_unit_x_decimals	Distance decimals	none
0057	rs232_unit_n_var_i	Physical units: Speed	none
0058	rs232_unit_n_conv_i	Physical units: Speed	none
0059	rs232_unit_n_numerator	Factor group speed numerator	none
005A	rs232_unit_n_divisor	Factor group speed denominator	none
005B	rs232_unit_n_decimals	Speed decimals	none
005C	rs232_unit_a_var_i	Physical units: Acceleration	none
005D	rs232_unit_a_conv_i	Physical units: Acceleration	none
005E	rs232_unit_a_numerator	Factor group acceleration numerator	none
005F	rs232_unit_a_divisor	Factor group acceleration denominator	none
0060	rs232_unit_a_decimals	Acceleration decimals	none
0061	rs232_kommando	Command word	none
0062	rs232_osc_screen_time	Total time	Basic unit time
0063	rs232_display_free_adr	Free CO address	CO number "free CO"
0070	errh_err_field_0	Bit field of main error numbers 1 to 32	Bit = 0: Error not active Bit = 1: Error active
0071	errh_err_field_1	Bit field of main error numbers 33 to 64	Bit = 0: Error not active Bit = 1: Error active
0072	errh_prio_field_0	Bit field of main error numbers 1 to 32	Error Bit = 0: Brake motor, power stage off
0073	errh_prio_field_1	Bit field of main error numbers 33 to 64	Bit = 1: Power stage off
0074	errh_warn_field_0	Bit field of main error numbers 1 to 32	Warning Bit = 0: Do not display warning
0075	errh_warn_field_1	Bit field of main error numbers 33 to 64	Bit = 1: Display warning

No .	Name	Meaning	Scaling
0080	curr_ i_u_act	Measured phase current of phase U	Basic unit current
0081	curr_ i_v_act	Measured phase current of phase V	Basic unit current
0082	ioh_uzk_volt	DC bus voltage (intermediate circuit voltage)	Basic unit voltage
0083	ioh_mot_temp	Motor temperature	Basic unit temperature
0084	ioh_power_stage_temp	Power stage temperature	Basic unit temperature
0085	ioh_din	Pin status of the digital inputs	none
0086	ioh_dout_data	Current status of the digital outputs Bit field,	DOUT0 ready for operation, hard-wired DOUT1 programmable DOUT2 programmable DOUT3 holding brake Hard-wired
0087	ioh_aout_range	Value range of the analog monitor (maximum) for both channels	Basic unit voltage
0088	ioh_aout_resolution_volt	Resolution of the analog monitor, indication of a voltage for one bit referred to the value range	Basic unit voltage
0089	ioh_dout2_1_func	Defines which functionality will be connected to which digital output.	none
008A	ioh_aout0_ko_nr	Analog monitor 0: Number of the communication object of the quantity to be displayed	Number of the communication object of the quantity to be displayed
008B	ioh_aout0_scale	Analog monitor 0: Scaling	Basic unit gain
008C	ioh_aout0_offset	Offset voltage for the analog monitor	Basic unit voltage
008D	ioh_aout1_ko_nr	Analog monitor 1: Number of the communication object of the quantity to be displayed	Number of the communication object of the quantity to be displayed
008E	ioh_aout1_scale	Analog monitor 1: Scaling	Basic unit gain
008F	ioh_aout1_offset	Offset voltage for the analog monitor	Basic unit voltage
0090	ioh_ain0_offs	Offset AIN0	Basic unit voltage
0091	ioh_ain1_offs	Offset AIN1	Basic unit voltage
0092	ioh_ain0_safezero	Safe zero	Basic unit voltage
0093	ioh_ain1_safezero	Safe zero	Basic unit voltage
0094	ioh_control	Configuration of analog monitors & temperature sensor	none
0095	ioh_pins_used	Optionally, the values for DIN0...DIN3 can be parameterized as AIN0, #AIN0, AIN1, #AIN1	none
00A0	eeval_enc_phi	Returns the rotor position without angle encoder offset	Basic unit degree
00A1	enc_config	Encoder configuration word	none
00A2	emu_ctrl	Setting of operating modes	none
00A3	eeval_enc_phi_offs	Offset angle of the angle encoder one revolution	Basic unit degree
00A4	eeval_x2b_line_cnt	Line count of an analog incremental encoder	Increments line count = 4 x line count

No .	Name	Meaning	Scaling
00A5	emu_enc_line_cnt	Number of output increments of the encoder emulation	Increments line count = 4 x line count (21...1024)
00A6	emu_enc_offset	Offset between the angle setpoint and the output angle of the encoder emulation	Basic unit degree
00A7	eeval_motid_w_status	Status of Motid_w	none
00A8	enc_sync_num	Numerator for the gear factor for the synchronization	none
00A9	enc_sync_div	Denominator for the gear factor for the synchronization	none
00AA	enc_encoder_status	Angle encoder status	none
00AB	enc_hiperface_line_cnt	Line count of a SINCOS encoder	none
00AC	eeval_enc_phi_offs_2	Offset angle of the 2 nd track, e.g. Hall encoder in the case of an incremental encoder	Basic unit degree
00C0	currc_i_q_act	Actual value of the active current in rotor coordinates	Basic unit current
00C1	currc_i_d_act	Actual value of the reactive current in rotor coordinates	Basic unit current
00C2	currc_i_q_ref	Setpoint of the active current in rotor coordinates	Basic unit current
00C3	currc_i_d_ref	Setpoint of the reactive current in rotor coordinates	Basic unit current
00C4	currc_iit_pwr_level	Current status of the i2t integrator for the power stage	Basic unit per cent
00C5	currc_iit_mot_level	Current status of the i2t integrator for the motor	Basic unit per cent
00C6	currc_i_lim_act	Current torque limitation limited to 0 - i_max	Basic unit current
00C7	currc_i_ref_rs232	Torque setpoint RS232	Basic unit current
00C8	currc_i_ref_can	Torque setpoint CAN	Basic unit current
00C9	currc_i_ref_ftd	Torque setpoint FTD	Basic unit current
00CA	currc_i_ref_profi	Torque setpoint Profi	Basic unit current
00CB	currc_i_lim_rs232	Parameterizable torque limitation RS232	Basic unit current
00CC	currc_i_lim_can	Parameterizable torque limitation CAN	Basic unit current
00CD	currc_i_lim_ftd	Parameterizable torque limitation FTD	Basic unit current
00CE	currc_i_lim_profi	Parameterizable torque limitation Profi	Basic unit current
00CF	currc_ctrl	Currc Control/Configword
00D0	currc_ctrl_gain_q	Active current controller P-gain	Basic unit gain
00D1	currc_ctrl_time_q	Active current controller time constant I-part	Basic unit time
00D2	currc_ctrl_gain_d	Reactive current controller P-gain	Basic unit gain
00D3	currc_ctrl_time_d	Reactive current controller time constant I-part	Basic unit time
00D4	currc_sel_i_switch	Torque setpoint selector	none
00D5	currc_sel_i_lim_switch	Torque limitation selector	none
00D6	ssel_ain0_i_per_volt	Torque setpoint scaling AIN0: Amperes per volt	Basic unit current
00D7	ssel_ain1_i_per_volt	Torque setpoint scaling AIN1: Amperes per volt	Basic unit current

No .	Name	Meaning	Scaling
00D8	curr_ i_ref_jog1	Jogging setpoint 1 (not supported)	Basic unit current
00D9	curr_ i_ref_jog2	Jogging setpoint 2 (not supported)	Basic unit current
00E0	ssel_n_ref	Speed setpoint (input variable of the speed controller)	Basic unit speed
00E1	ssel_n_act	Actual speed value	Basic unit speed
00E2	ssel_n_act_disp	Actual speed value (filtered) for display in D2SC	Basic unit speed
00E3	spdc_n_ref_rs232	RS232 speed setpoint	Basic unit speed
00E4	spdc_n_ref_can	CAN speed setpoint	Basic unit speed
00E5	spdc_n_ref_ftd	FTD speed setpoint	Basic unit speed
00E6	spdc_n_ref_profi	Profi speed setpoint	Basic unit speed
00E7	spdc_n_ref_hilf_rs232	Auxiliary RS232 speed setpoint	Basic unit speed
00E8	spdc_n_ref_hilf_can	Auxiliary CAN speed setpoint	Basic unit speed
00E9	spdc_n_ref_hilf_ftd	Auxiliary FTD speed setpoint	Basic unit speed
00EA	spdc_n_ref_hilf_profi	Auxiliary Profi speed setpoint	Basic unit speed
00EB	ssel_ctrl_stat	Speed control configuration	none
00EC	spdc_ctrl_gain	Controller P-gain	Basic unit gain
00ED	spdc_ctrl_time	Controller time constant I-part	Basic unit time
00EE	spdc_sel_n_switch	Speed controller selector for speed setpoint	none
00EF	spdc_sel_h_n_switch	Auxiliary setpoint selector for speed setpoint	none
00F0	ssel_ain0_n_per_volt	Speed setpoint scaling AIN0: Number of revolutions per volt	Basic unit speed
00F1	ssel_ain1_n_per_volt	Speed setpoint scaling AIN1: Number of revolutions per volt	Basic unit speed
00F2	ssel_time_c_n_act_filter	Filter time constant of actual speed value filter	Basic unit time
00F3	ssel_n_acc_pos	Ramp generator - gradient at: Positive speed - rising edge	Basic unit acceleration
00F4	ssel_n_dec_pos	Ramp generator - gradient at: Positive speed - falling edge	Basic unit acceleration
00F5	ssel_n_acc_neg	Ramp generator - gradient at: Negative speed - rising edge	Basic unit acceleration
00F6	ssel_n_dec_neg	Ramp generator - gradient at: Negative speed - falling edge	Basic unit acceleration
00F7	ssel_lim_sw_ramp_dec	Deceleration for limit switch ramp	Basic unit acceleration
00F8	ssel_enab_off_ramp_dec	Deceleration for quick stop ramp	Basic unit acceleration
00F9	spdc_n_target_speed	Declared speed for message. When n_mel +/- n_mel_hyst is reached, one bit will be set in the status word.	Basic unit speed
00FA	spdc_n_target_win_speed	Hysteresis for speed messages: n_ist = n_mel and n_ist = n_soll	Basic unit speed
00FB	spdc_ramp_brake_max_time	Maximum time at quick stop	Basic unit time
00FC	n_ramp_brake_min	Speed at which quick stop was successfully completed	Basic unit speed
00FD	spdc_n_ref_jog1	Jogging setpoint 1 (not supported)	Basic unit speed
00FE	spdc_n_ref_jog2	Jogging setpoint 2 (not supported)	Basic unit speed

No .	Name	Meaning	Scaling
00FF	ssel_n_act_ixr	Actual speed value calculated through machine model	Basic unit speed
0100	ssel_n_act_filter	Actual speed value filtered with actual speed value filter	Basic unit speed
0110	pssel_x_act	Actual position value	Basic unit position
0111	ioh_pos_selector	Value of target selector valid at present	0..63 = position data sets
0112	posi_bus0_pointer	Pointer at current position parameter through RS232	0..63 = position data sets
0113	posi_bus1_pointer	Pointer at current position parameter through CAN	0..63 = position data sets
0114	posi_bus2_pointer	Pointer at current position parameter through FTD	0..63 = position data sets
0115	posi_bus3_pointer	Pointer at current position parameter through Profi	0..63 = position data sets
0116	posc_ctrl_gain	Position controller gain	Basic unit gain
0117	posc_n_lim_pos	symmetric limitation of the max. output velocity from the position controller	Basic unit speed
0118	pos_sel_parameter	Position controller setpoint selector	none
0119	posc_x_diff_time	Time until following error is triggered	Basic unit time
011A	posc_x_diff_lim_pos	Following error (position difference set/actual)	Basic unit position
011B	posc_x_dead_rng_pos	Position difference dead range	Basic unit position
011C	ipo_sw_lim_pos	Positive position limit - software limit switch	Basic unit position
011D	ipo_sw_lim_neg	Negative position limit - software limit switch	Basic unit position
011E	posi_bus0_start_delay	Start delay after start of a positioning run / applies to all position targets	Basic unit time
011F	posi_bus0_x_trig	Remaining distance for remaining distance trigger; applies to all position targets	Basic unit position
0120	posc_x_target_win_pos	"Target reached" tolerance window	Basic unit position
0121	posc_x_target_time	"Target reached" time constant	Basic unit time
0122	pssel_home_offs	Offset for homing run	Basic unit position
0123	posi_bus0_ctrl	Control word for the characteristics and the process of the current positioning run	none
0124	posi_bus0_x_end_h	Target position in selected position set	Basic unit position
0125	posi_bus0_v_max	Running speed during positioning run Positioning group parameter	Basic unit speed
0126	posi_bus0_v_end	Final speed during positioning run At present = 0 Positioning group parameter	Basic unit speed
0127	posi_bus0_a_acc	Acceleration in the motor range of the drive Positioning group parameter	Basic unit acceleration
0128	posi_bus0_a_dec	Acceleration in the generator range of the drive; deceleration Positioning group parameter	Basic unit acceleration
0129	posi_bus0_a_acc_jerkfree	Jerk-free parts during acceleration Positioning group parameter	Basic unit time
012A	posi_bus0_a_dec_jerkfree	Jerk-free parts during deceleration Positioning group parameter	Basic unit time

No .	Name	Meaning	Scaling
012B	seqc_homing_method	Homing method	In accordance with CANopen DSP 402
012C	ssel_ain0_x_per_volt	Position setpoint scaling AIN0: Revolutions per volt	Basic unit position
012D	ssel_ain1_x_per_volt	Position setpoint scaling AIN1: Revolutions per volt	Basic unit position
012E	seqc_home_sw_zero_dist	Distance between index pulse and reference (limit switch, home switch) (not supported)	Basic unit position
012F	seqc_home_sw_zero_min	Minimum distance between index pulse and reference (limit switch, home switch) (not supported)	Basic unit position
0130	pos_x_ref	Current position setpoint	Basic unit position
0131	pos_control_n_korr	Position controller output	Basic unit speed
0132	posi_rev_dist	Reversing distance (not supported)	Basic unit position
0133	pos_sel_x_switch	Position controller selector for position setpoint	none
0134	pos_sel_n_switch	Setpoint selector for speed feedforward	none
0135	pos_can_x_ip	Position setpoint in selected position set	Basic unit position
0136	pos_bus0_delay	Start delay after start of a positioning run / applies to all position targets	Basic unit time
0137	posc_x_diff_32b	Current position difference between the current position setpoint and the actual position	Basic unit position
0138	pos_sel2_x_switch	Position controller selector for position setpoint	none
0139	pos_sel2_n_switch	Setpoint selector for speed feedforward	none
0140	can_node_id	Node number resulting from basis and offset	1 ... 127
0141	can_node_id_offset	Node number offset through digital inputs	0 ... 63
0142	can_node_id_base	Basic node number for CAN	0 ... 127
0143	can_baudrate	Sets the baud rate for the CAN bus to kBaud	kBaud 125; 250; 500
0144	can_comm_active	Activates the CANopen protocol	1: CANopen
0145	can_options	Sets various options	none
0146	can_pdo_tx0_mapped	Identifier of mapped SDO object 0 (transmit)	none
0147	can_pdo_tx1_mapped	Identifier of mapped SDO object 1 (transmit, option)	none
0148	can_pdo_rx0_mapped	Identifier of mapped SDO object 0 (receive)	none
0149	can_pdo_rx1_mapped	Identifier of mapped SDO object 1 (receive, option)	none
014A	can_sync_time_slot	Nominal interval between two SYNC frames on the CAN bus (required for interpolated position mode)	none
014B	can_pos_fact_num	Numerator of the factor for position representation	none

No .	Name	Meaning	Scaling
014C	can_pos_fact_div	Denominator of the factor for position representation	none
014D	can_val_fact_num	Numerator of the factor for speed representation	none
014E	can_vel_fact_div	Denominator of the factor for speed representation	none
014F	can_acc_fact_num	Numerator of the factor for acceleration representation	none
0150	can_acc_fact_div	Denominator of the factor for acceleration representation	none
0160	osc_control	Oscilloscope control word, operating modes	none
0161	osc_status	Oscilloscope status word, operating modes	none
0162	osc_samples	Number of sampling processes	Number of sample values per channel
0163	osc_sample_time	Minimum sampling time between two samples	Basic unit time
0164	osc_triggermask	Oscilloscope trigger mask for digital triggers	Permissible are '01L, '02L, '04L, etc., 'FFL
0165	osc_triggerconfig	Trigger configuration bit field	none
0166	osc_triggerlevel	Trigger level ('analog') or level ('digital')	Depending on the quantity to be recorded
0167	osc_timebase	Number of cycles until next storage	Multiple of sampling time $t(\text{sampl}) = \text{osc_timebase} * \text{osc_sample_time}$
0168	osc_delay	Trigger delay	Number of samples Value > 0 : Recording of events after trigger Value < 0 : Recording of events before trigger
0169	osc_data0	Function number for channel recording	none
016A	osc_KO_nr0	Free CO address	CO number "free CO"
016B	osc_KO_mask0	Optimal mask to hide unnecessary bits or value ranges in a communication object.	none
016C	osc_data1	Function number for channel recording	none
016D	osc_KO_nr1	Free CO address	CO number "free CO"
016E	osc_KO_mask1	Optimal mask to hide unnecessary bits or value ranges in a communication object.	none
016F	osc_data2	Function number for channel recording	none
0170	osc_KO_nr2	Free CO address	CO number "free CO"
0171	osc_KO_mask2	Optimal mask to hide unnecessary bits or value ranges in a communication object.	none
0190	ftd_pointer_course_prog	Pointer at an entry in a course program	none
0191	ftd_line_course_prog	Pointer at a line in a course program	none
0192	ftd_line_course_prog_akt	Pointer at currently processed line in a course program	none
0193	ftd_line_course_prog_start	Sets the start lines for 1 and 2	none

Basic units

Table 25: List of basic units

Quantity	Representation	Resolution	Resulting value range
Current	32 bits	$1 / 2^{16}$ A	$\pm 2^{15}$ A
Acceleration	32 bits	$1 / 2^8$ rpm/s	$\pm 2^{23}$ rpm/s
Speed	32 bits	$1 / 2^{12}$ rpm	± 524.288 rpm
Position	32 bits	$1 / 2^{16}$ R	$\pm 2^{15}$ R
Torque constant	32 bits	$1 / 2^{12}$ Nm/A	± 524.288 Nm/A
Voltage	32 bits	$1 / 2^{16}$ Volt	$\pm 2^{15}$ Volt
Power	32 bits	$1 / 2^8$ VA	$\pm 2^{23}$ VA
Gain	32 bits	$1 / 2^{16}$	$\pm 2^{15}$
Time constant	32 bits	$0,1 \mu\text{s} = 10^{-7}$ s	430 s
Temperature	16 bits	$1 / 2^4$ °C	$\pm 2^{11}$ °C
32-bit-factor	32 bits	$1 / 2^{16}$	$\pm 2^{15}$
16-bit-factor (%)	16 bits	$1 / 2^{16}$	0...1 (0...+100%)
Resistance	32 bits	$1 / 2^8$	0...16,7 MΩ
Torque change	32 bits	$1 / 2^8$ A/s	$\pm 2^{23}$ A/s

11.7.2 Bit configuration for command word / status word / error word

Command word (seqc_opmode)	
Bit	Meaning
31	Controller reset (hardware reset via commh)
30	Debug mode 0 = off, 1 = on
29	
28	Load default parameters from program memory (init!)
27	
26	
25	
24	
23	
22	
21	
20	
19	
18	Setpoint lockout (activated internally by the controller)
17	Direction bit 0 = left-handed rotation, 1 = right-handed rotation (inverts the speed setpoints and the position setpoints), in the torque control mode also the torque setpoints
16	Error acknowledgement
15	
14	
13	
12	Positioning or homing start
11	
10	Rotation direction reversal (inverted rotation direction with identical setpoints)
9	
8	
7	
6	Activate synchronous positioning submode
5	Activate homing
4	Activate positioning
3	Activate speed control
2	Activate torque control
1	Activate position control
0	Controller enable

Status word (rs232_stat_sum)	
Bit	Meaning
31	
30	
29	
28	
27	MOTID mode
26	
25	
24	INTERNAL controller and output stage enabling
23	
22	
21	Automatic encoder adjustment active
20	Homing run performed
19	Positive direction blocked
18	Negative direction blocked
17	Common error message
16	Warning message (no common error and no shut-down)
15	Ready for operation
14	Output stage switched on
13	Speed message $n_actual = (0 \pm n_mel_hyst)$
12	SinCos encoder activated
11	iit monitoring → limitation to nominal current; IIT motor / servo
10	Positioning run started (activated for the duration of an IPO cycle)
9	Speed message $n_actual = (n_soll \pm n_mel_hyst)$
8	1 = speed message $n_actual = (n_mel \pm n_mel_hyst)$
7	
6	Remaining distance of positioning run reached (set to zero at the start of the follow-up positioning)
5	“Destination reached” message ($n_actual = x_setpoint \pm x_mel_hyst$)
4	Message “positioning completed” ($x_setpoint = pos_x_actual$) (set to zero at the start of the follow-up positioning).
3	Positive limit switch reached DIN8
2	Negative limit switch reached DIN7
1	Home switch reached
0	Homing active

Error word (low) (errh_err_field_0)	
Bit	Meaning
31	
30	Error limit switch
29	
28	Following error monitoring
27	Output stage temperature 5°C below maximum
26	Motor temperature 5°C below maximum
25	I ² T at 80%
24	
23	
22	
21	
20	
19	Controller I ² T error (I ² T at 100%)
18	Motor I ² T error (I ² T at 100%)
17	
16	SINCOS track signal error
15	Intermediate circuit overvoltage
14	Intermediate circuit undervoltage
13	Overcurrent intermediate circuit / output stage
12	Current measurement offset error
11	
10	24V supply error (out of range)
9	12V electronic system supply error
8	5V electronic system supply error
7	Resolver track signal error / carrier failure
6	SINCOS track signal error
5	SINCOS RS485 communication error
4	SINCOS supply error
3	Electronic power system under-/overtemperature
2	Motor overtemperature
1	
0	

Error word (high) (errh_err_field_1)	
Bit	Meaning
31	Initialization error
30	Checksum error
29	Stack overflow
28	
27	Pos. precomputation error
26	
25	Operating mode error
24	Position data set error
23	RS232 communication error
22	CAN communication error
21	
20	
19	
18	
17	
16	
15	
14	
13	
12	
11	Course program branch destination error
10	Course program unknown command error
9	
8	
7	Motor identification error
6	
5	
4	
3	Homing error
2	Timeout at quick stop
1	
0	

Extended options in the "Display units" menu

Configuration of user-defined display units

If you click the **User-defined** button in the **Display mode** field, you can adapt the display units to your application.



User-defined units are marked by [..].

You can enter the scaling in **User-defined units per revolution** into the **Feed constant** field in the **Translatory application** section.

Example:

You have a drive with 1.76 inch per revolution, without a gearbox. You would like to enter the position in inch. You have to enter 1.76 into the **Feed constant** field.

In addition, the input fields **Time base speed** and **Time base acceleration** are available.

Use the field **Time base speed** to define your own speed units.

Example: (rotary operation)

You have a drive with 20 mm per revolution, without a gearbox. You would like to enter the speed in mm/minute. Enter 20 into the **Feed constant** field and 60 into the **Time base speed** field (60 seconds = 1 minute)

Use the field **Time base acceleration** to define your own acceleration units.

Example:

You have a drive with 20 mm per revolution, without a gearbox. You would like to enter the acceleration in (mm/minute)/s. Enter 20 into the **Feed constant** field and 60 into the **Time base speed** field. (1 minute x 1 s = 60 x 1 s² = 60 s²)

Decimal places

Another way of configuring the display units is the configuration of decimal places. You can enter the number of decimal places for the position, speed and acceleration unit (from 0 to 5) on the **Decimal places** tab in the menu **Options/Display units**.

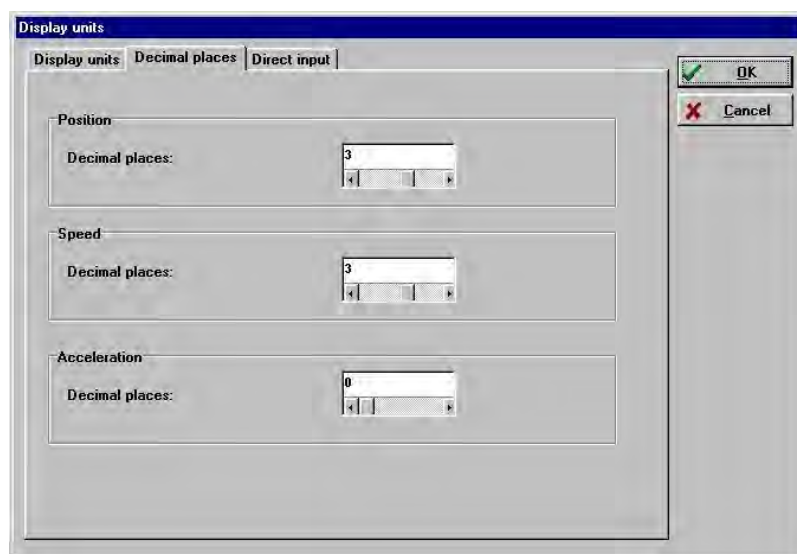

Direct input of distance, speed and acceleration units.

On the **Direct input** tab, you can directly enter values for the factor groups **Position**, **Speed** and **Acceleration**, if you have previously selected the **Direct input** option in the **Display mode** field on the **Display units** tab.



Caution! For experienced users only!

The direct input of physical units allows drastic changes of the controller parameters of the DUET_FL servo positioning controller.

You can also select from the following units for the display of the parameterization program:

- ❖ Increments
- ❖ Degree
- ❖ Radian
- ❖ Revolutions

- ❖ Metre
- ❖ Millimetre
- ❖ Micrometre
- ❖ User-defined
- ❖ No unit

Here an example in millimetres and hexadecimal display:

Course program: Examples

This chapter includes several example to demonstrate the flexible solutions possible with the course program.



The input of course programs is described in *chapter Creating a course program*.

6.3.1 Example 1: Linear linking of positions

The drive shall approach the positions 1 - 2 - 3 - 18. It shall stop for 1 second in every position. Then the course program shall stop.

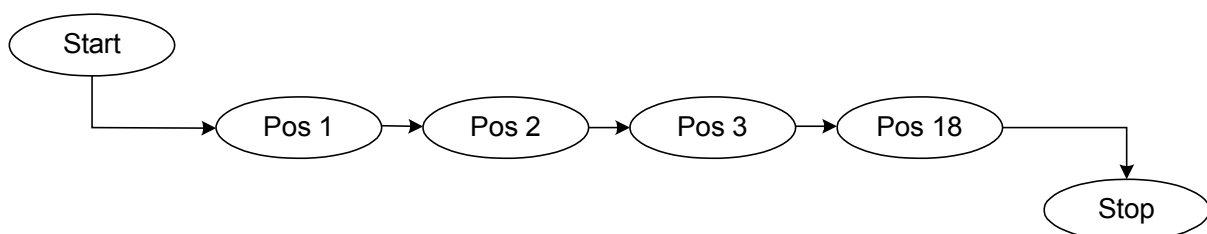

Realization:

Course program								
Nr.	CMD	STOP	NEXT1	Pos/line 1	NEXT2	Pos/line 2	DOUT1	DOUT2
0	Posi	ignore	automatic	1	ignore	-	Off	Off
1	Posi	ignore	automatic	2	ignore	-	Off	Off
2	Posi	ignore	automatic	3	ignore	-	Off	Off
3	Posi	ignore	automatic	18	ignore	-	Off	Off
4	End	ignore	-	-	-	-	-	-
5	End	accept	-	-	-	-	-	-
6	End	accept	-	-	-	-	-	-
7	End	accept	-	-	-	-	-	-
8	End	accept	-	-	-	-	-	-

Modus Debug Edit

Course program active NEXT1 DOUT1 Line: 4
 Course program stop NEXT2 DOUT2 Position: 18

Implementation:

- ❖ The start delay for positions 1, 2, 3 and 18 has to be parameterized when the destinations are programmed.

Example 2: Linear linking of positions and setting of a digital output

The drive shall approach the positions 1 - 2 - 3 - 18. It shall stop for 1 second in every position. Then the course program shall stop.

When the drive reaches position 3, the digital output DOUT1 shall be set to HIGH for one second.

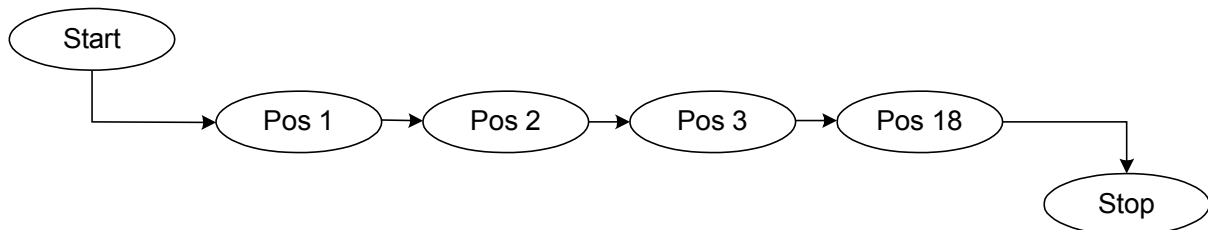

Realization:

Course program								
Nr.	CMD	STOP	NEXT1	Pos/line 1	NEXT2	Pos/line 2	DOUT1	DOUT2
0	Posi	ignore	automatic	1	ignore	-	Off	Off
1	Posi	ignore	automatic	2	ignore	-	Off	Off
2	Posi	ignore	automatic	3	ignore	-	Target	Off
3	Posi	ignore	automatic	18	ignore	-	Target	Off
4	End	ignore	-	-	-	-	-	-
5	End	accept	-	-	-	-	-	-
6	End	accept	-	-	-	-	-	-
7	End	accept	-	-	-	-	-	-
8	End	accept	-	-	-	-	-	-

Modus Debug Edit

Course program active NEXT1 DOUT1 Line: 4
 Course program stop NEXT2 DOUT2 Position: 18

Implementation:

- ❖ Positions 1, 2, 3 and 18 are parameterized with a start delay of 1 second.
- ❖ The "target reached" setting for DOUT1 must be listed in line 3 and 4 as the setting "ON" and "OFF" will be taken over immediately and the signal would not be applied for one second. When the drive moves to position 18, DOUT1 will be cleared.

Example 3: Setting and inquiring digital inputs and outputs; infinite loops

First, DOUT1 shall be set to HIGH for one second. Then the system shall wait until NEXT1 is active.

Once this is the case, the drive will move infinitely to position 16 (start delay 3 seconds).

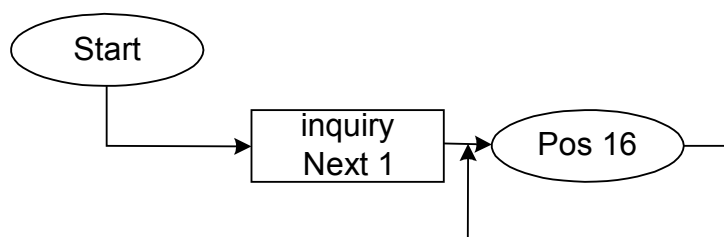

Realization:

Course program								
Nr.	CMD	STOP	NEXT1	Pos/line 1	NEXT2	Pos/line 2	DOUT1	DOUT2
0	Posi	ignore	automatic	0	ignore	-	On	Off
1	Jump	ignore	automatic	2	ignore	-	On	Off
2	Posi	ignore	complete(pos.)	16	ignore	-	Off	Off
3	Posi	ignore	automatic	16	ignore	-	Off	Off
4	Jump	ignore	automatic	3	ignore	-	Off	Off
5	End	accept	-	-	-	-	-	-
6	End	accept	-	-	-	-	-	-
7	End	accept	-	-	-	-	-	-
8	End	accept	-	-	-	-	-	-

Modus: Debug Edit

File >> Program Edit line Program >> File Exit

Course program active NEXT1 DOUT1 Line: 4
 Course program stop NEXT2 DOUT2 Position: 16

Implementation:

- ❖ A trick is used to realize the defined setting of DOUT1: Position 0 is set to 0 revolutions (relatively) with a start delay of 1 second. At first, the drives "approaches" position 0 and DOUT1 is set to HIGH. Then the program jumps to line 2.
- ❖ To obtain an infinite loop, line 4 contains a program line jump to line 3.

Timing diagrams

The following diagrams show some typical applications of the DUET_FL servo positioning controller and the corresponding timing of the digital inputs and outputs. Since some times depend on the operating status of the controller, only approximate values can be given in some cases. In these cases, the control system has to inquire additional status messages of the DUET_FL.

The times stated in the diagrams have a tolerance of $\pm 100 \mu\text{s}$. This tolerance has to be taken into consideration in addition to the times given in the timing diagrams!



The DUET_FL position controller has a sequential control with a time base of 1.6 ms. The statuses of the digital inputs and outputs are checked and updated cyclically.

The cycle time of the SPC or of the control must be set to values $< (1.6 \text{ ms} - 100 \mu\text{s}) = 1.5 \text{ ms}$ so that the SPC can detect all messages from the DUET_FL. On the other hand, all the control signals from the SPC must be applied $> (1.6 \text{ ms} + 100 \mu\text{s}) = 1.7 \text{ ms}$ in order to ensure that the DUET_FL can recognize the signals correctly.

Example: SPC with $t_{\text{cycle}} = 1 \text{ ms}$ \rightarrow setting of the SPC outputs for at least $2 \times t_{\text{cycle}} = 2 \text{ ms}$

11.10.1 Switch-on sequence

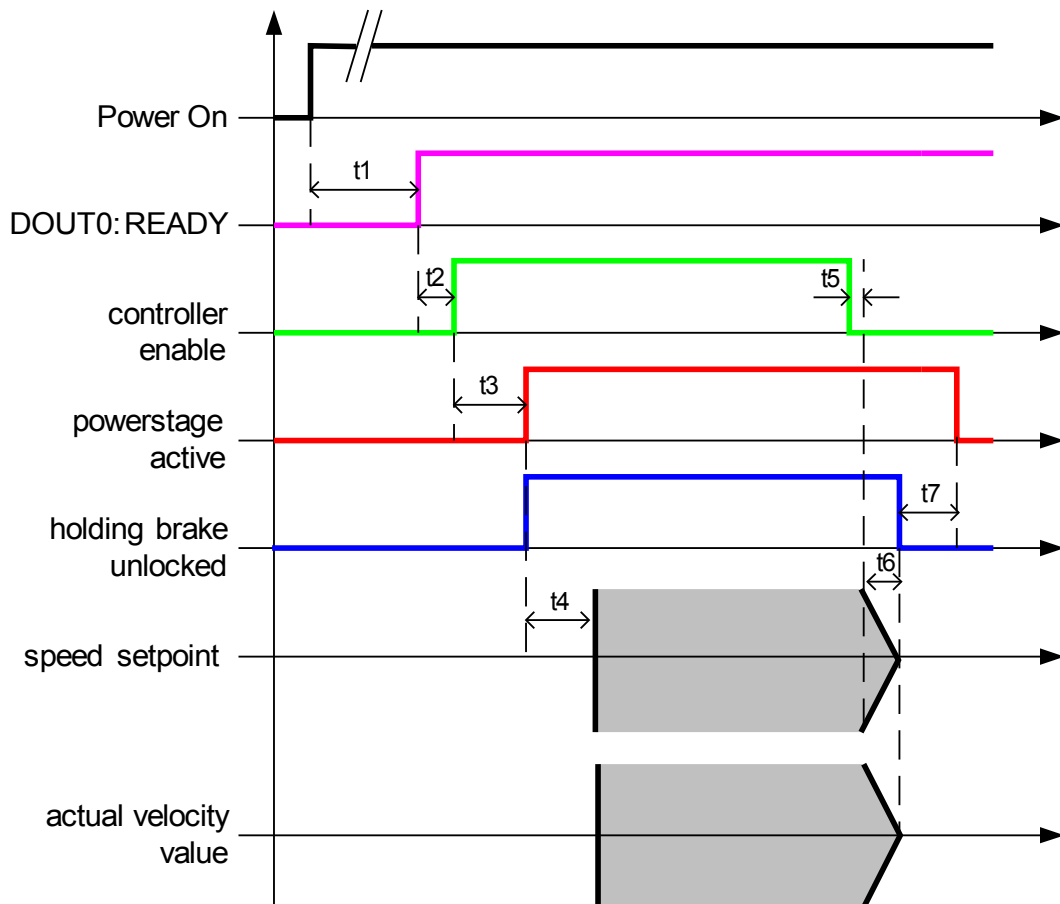

- $t_1 \approx 500 \text{ ms}$ Boot program and start of the application
- $t_2 > 1.6 \text{ ms}$
- $t_3 \approx 10 \text{ ms}$ Depends on the operating mode and on the status of the drive
- $t_4 = N \times 1.6 \text{ ms}$ Can be parameterized (run delay braking parameter)
- $t_5 < 1.6 \text{ ms}$
- $t_6 = N \times 0.2 \text{ ms}$ Depends on the quick stop ramp
- $t_7 = N \times 1.6 \text{ ms}$ Can be parameterized (stop delay braking parameter)

Positioning / Destination reached

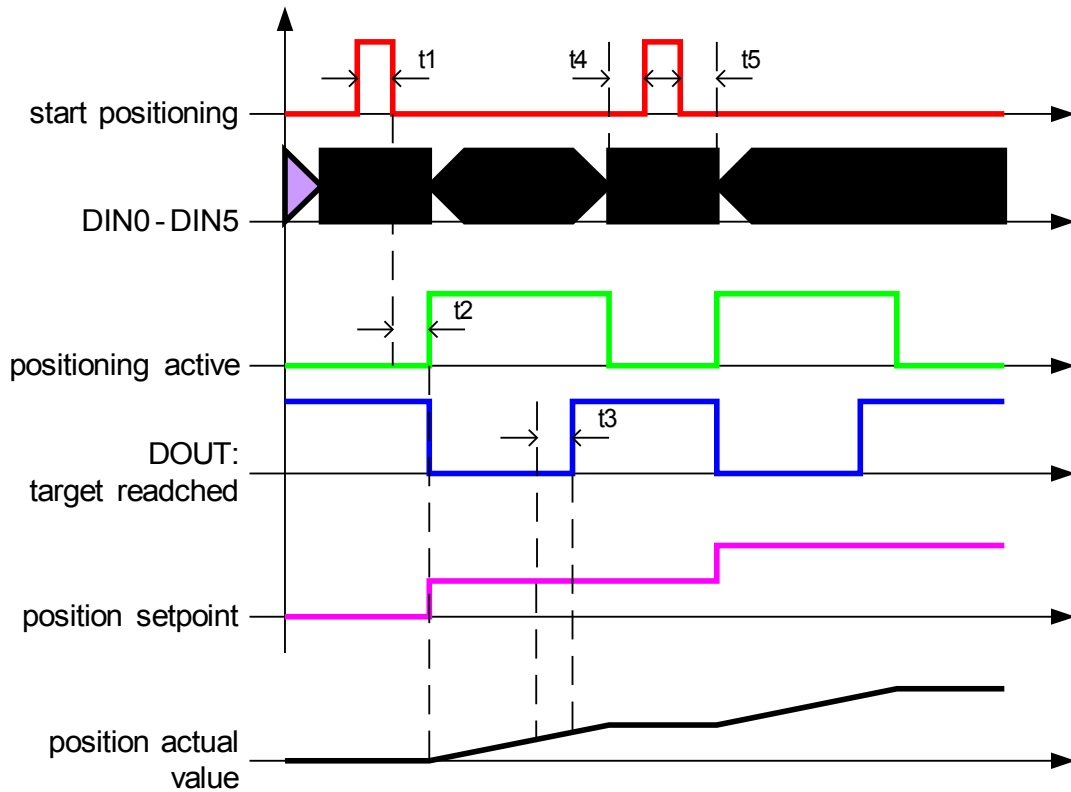

- $t1 > 1.6 \text{ ms}$ Pulse length of the START signal
- $t2 < 1.6 \text{ ms}$ Delay until the drive starts
- $t3 = N \times 1.6 \text{ ms}$ Target window reached + response delay
- $t4 > 1.6 \text{ ms}$ Position selection set-up time
- $t5 > 1.6 \text{ ms}$ Position selection hold-time

Speed signal

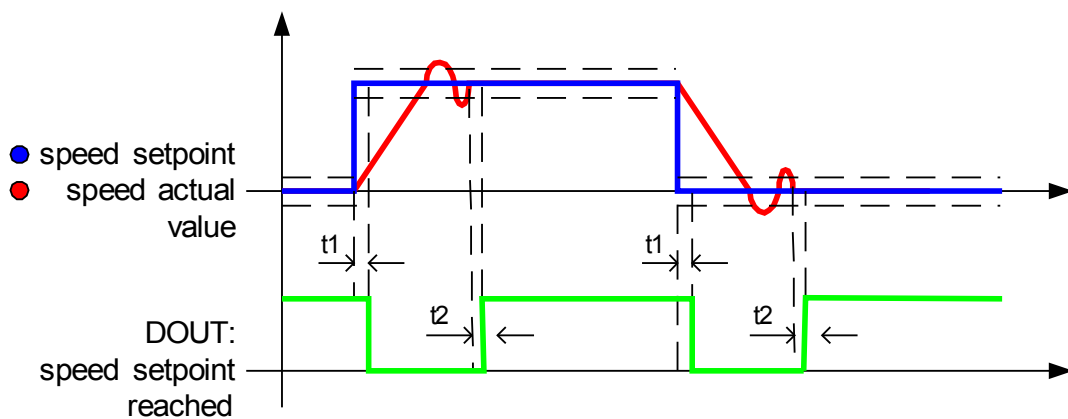

- $t1 < 1,6 \text{ ms}$
- $t2 < 1,6 \text{ ms}$

Quit error

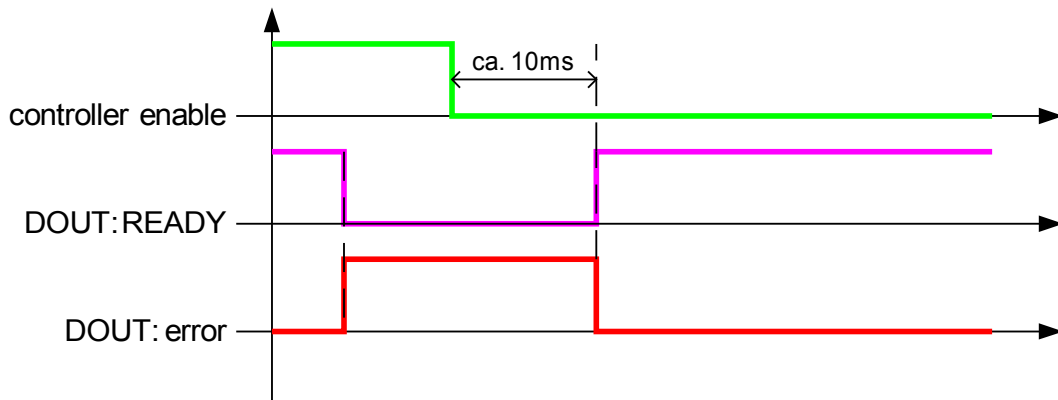

Limit switch

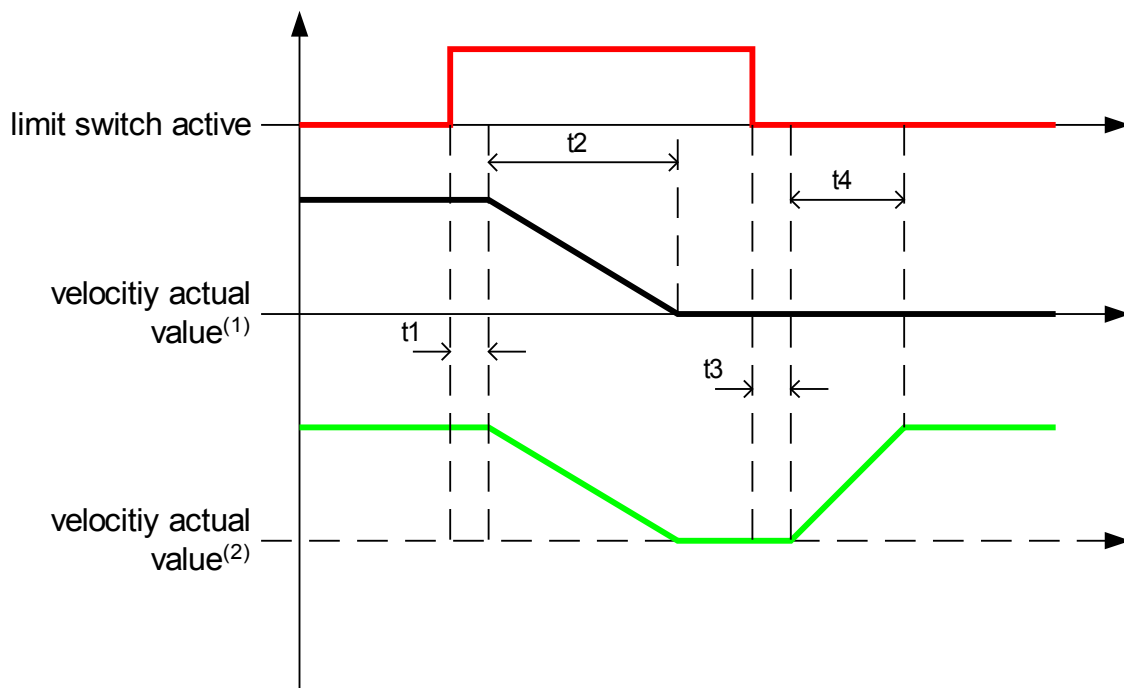

- $t1 < 0.2 \text{ ms}$
- $t2 = N \times 0.2 \text{ ms}$ Depends on the quick stop ramp
- $t3 < 0.2 \text{ ms}$
- $t4 = N \times 0.2 \text{ ms}$ Depends on the speed ramp

Actual speed⁽¹⁾: Direction of rotation permanently blocked by the limit switch.

Actual speed⁽²⁾: Direction of rotation not permanently blocked by the limit switch.

Parameter set management

General

In order for the DUET_FL servo positioning controller to control the motor properly, the properties of the DUET_FL servo positioning controller must be set correctly. In the following, the individual properties are called **parameters**. The total of all parameters for a servo positioning controller/motor combination is called a **parameter set**.

The following illustrations shows how the parameter sets are managed:

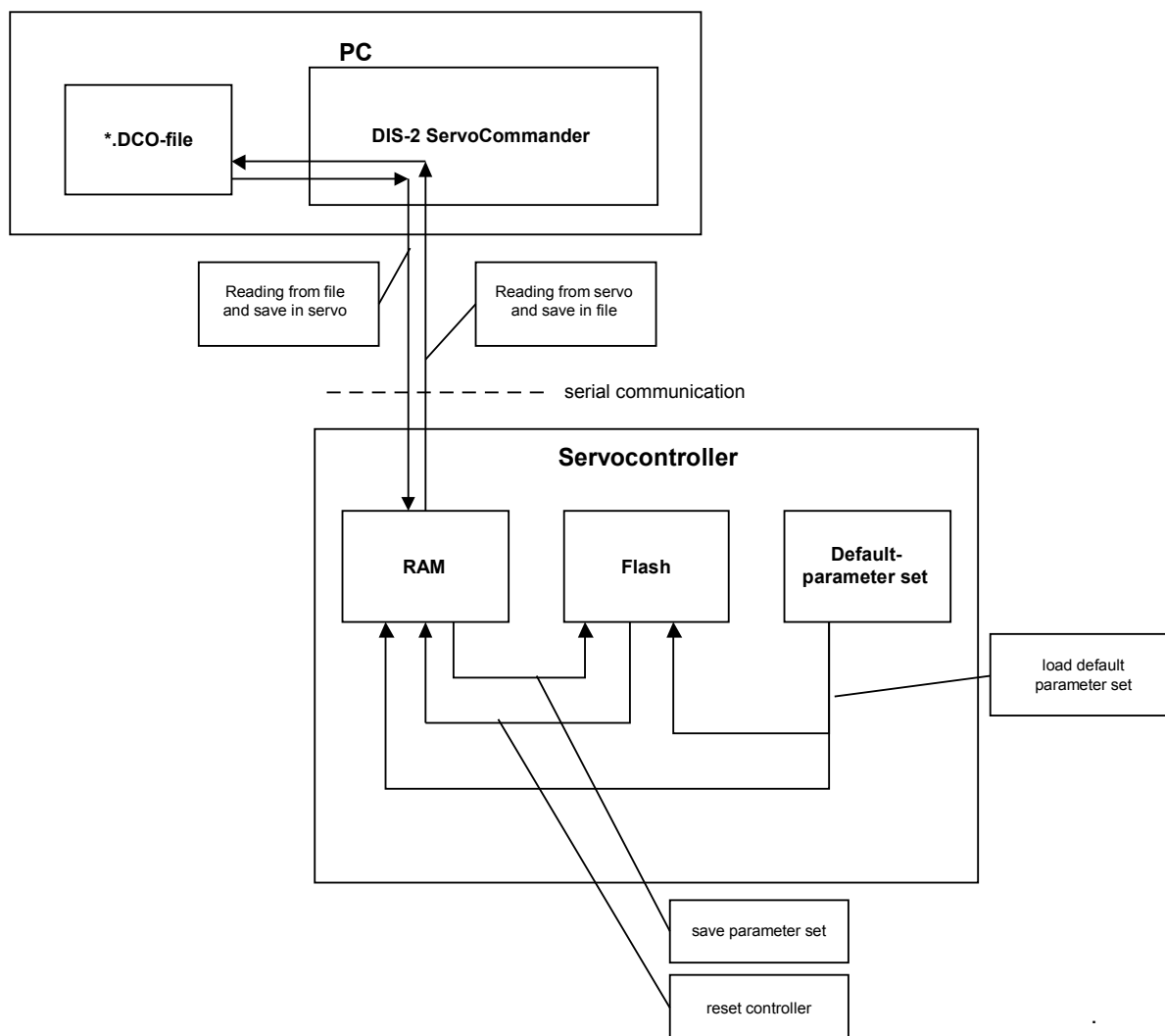

Figure 28: Online parameterization

The current parameter set of the DUET_FL servo positioning controller is stored in the RAM (RAM = Random Access Memory). The RAM loses its contents when the power supply is switched off. In order to permanently save a parameter set, it can be copied into the controller memory using the command **File/Parameter set/Save parameter set**. The memory keeps its contents even if the power supply is switched off.

When the servo positioning controller is reset, the contents of the FLASH memory are copied into the RAM. A reset can be initiated as follows:

- ❖ Deactivation and reactivation of the power supply
- ❖ Activation of the menu item **File/Reset Servo**
 - ❖ Activation of the RESET button in the toolbar of the parameterization program

The DUET_FL also has **default parameter set**. This parameter set is fixed in the firmware and cannot be overwritten. If a parameterization is not successful for some reason, the default parameter set can be loaded to continue with default values. The default parameter set is activated by selecting **File/Parameter set/Load default parameter set**. The default parameter will then be copied into the FLASH memory and into the RAM.

Loading and saving parameter sets

Parameters can also be stored and managed externally (i.e. on a hard disk or floppy disk etc.). The parameter set is read by the DUET_FL servo positioning controller and saved to a file, or it is read from a file and saved in the DUET_FL servo positioning controller.

The extension of the parameter files on the PC end is ***.DCO**. The following menus of the parameterization program are used for reading and writing of the *.DCO files:

- ❖ **File/Parameter set/File >> Servo:** This command transfers a *.DCO file from the PC to the servo
- ❖ **File/Parameter set/Servo >> File:** This command writes a *.DCO file to the PC

Please note that when writing a parameter set to a file on the PC, you can fill in the fields **Motor type** and **Description**. You can also enter a comment of up to 100 lines if you select the **Comments** tab. We highly recommend generating descriptions to prevent confusions of parameter sets. The name of the parameter set should also be selected carefully to facilitate finding the right file.



Please use the comment fields to save information.



*.DCO files can be sent from one location to another on floppy disks, CD-ROMs and/or by e-mail.

Printing parameter sets You can print parameter set in plain text, display and save them by selecting the menu option **File/Parameter set/Print**. The following menu will be displayed:

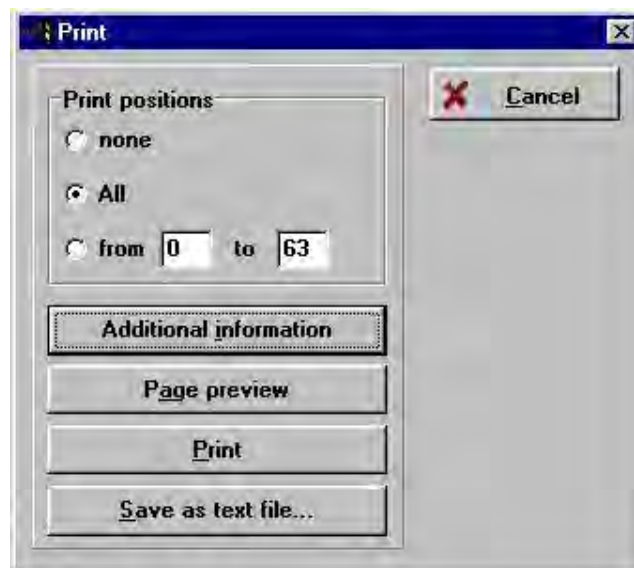

In the **Print positions** field, you have to select the positions to be printed at the end of the parameter list.

The selection affects the length of the plain text output. You can expect:

- ❖ none The parameter list output will not include any position sets.
Length: about 5 pages
- ❖ all The output will include all 64 position sets.
Length: about 7 pages
- ❖ from...to The position range can be defined explicitly.

The buttons of the **Print** menu have the following meaning.

- ❖ Additional information Calls up the corresponding submenu.
- ❖ Page preview Creates the plain text output and displays it on the screen.
- ❖ Print Creates the plain text output and prints it on the printer.
- ❖ Save as text file Creates the plain text output and saves it under a name defined by the user. The default directory of the plain text output is the \txt sub-directory.

When the plain text output is created for the page preview and for printing, the file \$\$\$.txt will be written into the \txt sub-directory.

Additional information

The user can enter additional information concerning the parameter set into this menu. The information will be taken over into the plain text output. This applies particularly to the date, which may differ from the current date.

The fields **Order**, **Comment1/2** and **Motor data** will be taken over unchanged into the plain text output. Enter the information as follows:

Field	Content
Order	ID of the order/project for which the parameter set was created
Comment1, Comment2	Special features of the parameter set
Motor data	ID of the motor data set (from the file motor.ini)

For formatting reasons, the entries should not be longer than half a line (about 40 characters).

The current data is the default date for the plain text output. The date field can be edited if you select the **Change** function. The date will be taken over into the plain text output.

Page preview

Press this button in the **Print** menu to create the plain text output and display it as a page preview. It is a preview of the print output.

Save as text file

If you click the **Save as text file** button, you can save the print output as a *.txt file on the hard disk and process it further (e.g. you can send it to another location by e-mail).







The text files are saved in the TXT subdirectory of the parameterization program.



Parameter sets can be printed in the online mode and in the offline mode.

Offline parameterizationThe tool bar underneath the menu bar indicates whether offline or online parameterization is active:

Table 26: Online/Offline activation

 Online	 Offline	Online parameterization active
 Online	 Offline	Offline parameterization active

The active mode is highlighted in green.

The parameterization program allows access to parameter sets even if no serial communication with the DUET_FL servo positioning controller has been established. This, however, requires the presence of a corresponding *.DCO file (see *chapter Loading and saving parameter sets*).

It is possible to

- ❖ read controller parameters from a *.DCO file
- ❖ change controller parameters
- ❖ save modified values in the same or in another *.DCO file
- ❖ print parameter sets (see also *chapter Printing parameter sets*).

In order to let the changes made become effective, the modified parameter set has to be loaded into the DUET_FL servo positioning controller (see *chapter Loading and saving parameter sets*).

The illustration below shows the principle of the offline parameterization:

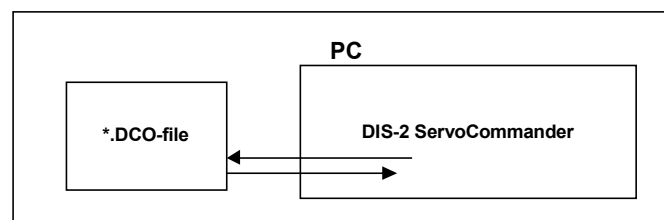



Figure 29: Offline parameterization

To activate the offline parameterization, click on the menu item **Options/Communication/Offline-parameterisation** or on the offline icon in the tool bar.

You will be asked which *.DCO file to open. Select a corresponding file.

	<p>DANGER !</p> <p>If you use a DCO file for a different type of device, make sure to check the configurations for rated current, maximum current, angle encoder offset, phase sequence, number of poles, current controller and speed controller, to prevent damages to the servo positioning controller/motor!</p>
---	---

During the offline parameterization, the parameterization program shows a behaviour which may deviate from the online parameterization:

- ❖ Certain menus (e.g. firmware download) are inaccessible.
- ❖ The menu **File/Parameter set** has different submenus:
 - **Open file**

- **Save file**
- **Save file as...**

- ❖ When you quit the program, you will be asked whether the currently open parameter file shall be saved.

To end the offline parameterization, click on the menu item **Options/Communication/Online-parameterization** or on the online icon in the tool bar.

Loading firmware into the DUET_FL / firmware update

The firmware is the "operating program" of the DUET_FL servo positioning controller. The controllers come supplied with a firmware loaded. Under the following circumstances it might be necessary to load a new firmware:

- ❖ Update to a new firmware version.
- ❖ Loading of a special firmware with customized functions in order to be able to use additional functions.
- ❖ Incomplete firmware (e.g. due to an interrupted firmware download).

Due to continuous product developments, the parameterization program may include options, which require a correspondingly advanced firmware version.

If the DUET_FL servo positioning controller has no firmware or if its firmware is complete, the following window will be displayed.



If the correct firmware is already installed in the DUET_FL servo positioning controller, the error message will not be displayed. In this case you can skip the following chapter!



To read out the firmware version installed in the controller, open the **Firmware / Hardware** tab in the **Info/Info** menu.

11.13.1 Loading the firmware

You can load a new firmware under **File/Firmware download**.

When a new firmware is loaded, the parameter set stored in the servo positioning controller will be overwritten. This is why the following message is displayed:

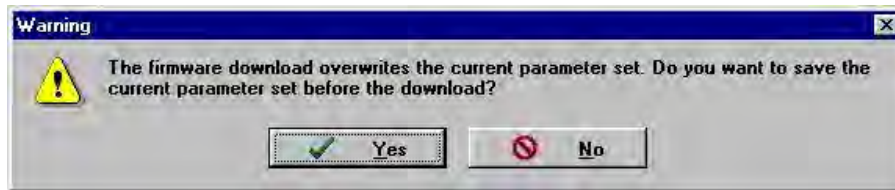

Here you can decide whether you want to save your parameter set on the PC. If you click the **Yes** button, the menu for saving the parameter set will be opened.

The following selection menu is displayed:



1. Select the firmware to loaded and click the **Open** button.
2. Then a window for selecting the data transfer rate (baud rate) opens:

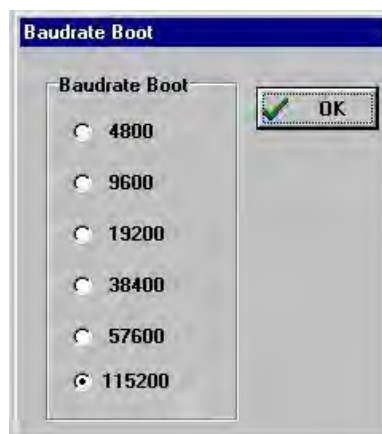

3. Try a baud rate of 115200 bauds. If this leads to data transfer problems (error messages), you have to reduce the baud rate for the next trial.

A successful firmware download is indicated by the message below:



If the firmware download was not successful, the message **Error at firmware download** will be displayed.



In most cases, this is due to a communication error during the transfer to data into the DUET_FL servo positioning controller. Repeat the process described above with a lower baud rate.

Technical data

Ambient conditions and qualification

Parameter	Values
Permissible temperature ranges	Storage temperature: -25°C to +70°C
	Operating temperature: 0°C to +50°C +50°C to +70°C with power decrease of 2%/K Temperature shut-down at about 80°C
Permissible altitude	Up to 1000 m above msl, 1000 to 4000 m above msl with power decrease
Atmospheric humidity	Rel. humidity up to 90%, non-condensing
Type of protection	IP54, depending on method of installation up to IP67
Pollution class	1
CE conformity:	
Low voltage directive	Not applicable
EMC directive:	EN 61 800 - 3
Other certifications	UL under preparation

11.13.2 Dimensions and weight

Parameter	Values
Dimensions (H*W*D)	65 x 90 x 100 mm (without mating connector)
Weight	approx. 500 g

11.13.3 Performance data

Parameter	Values
Intermediate circuit voltage (DC bus voltage)	0 V... 60 V DC (48 V DC rated / 15 A rated) ¹⁾
24V supply	24 V DC [$\pm 20\%$] / 200 mA ²⁾ $U_{\text{Ripple}} > 1,5 V_{\text{ss}, 100\text{Hz}}$ + 700 mA ³⁾ + 100 mA ⁴⁾ Internally protected through a poly-switch, switches at about 1 A
Braking resistor connection	$R_{\text{BR}} \geq 4.7 \Omega$ / $P_{\text{nom}} = 20 \text{ W} \dots 200 \text{ W}$ (only present in DUET_FL 48/10 FB!)
Brake chopper DUET_FL FB	Switching threshold ON: $U_{\text{chop_on}} = 60 \text{ V} [\pm 5\%]$ Switching threshold OFF: $U_{\text{chop_off}} = 55 \text{ V} [\pm 5\%]$

¹⁾ An external 15A fuse is required.

²⁾ Current consumption of the DUET_FL 48/10 without additional wiring

- ³⁾ Maximum admissible current consumption of an optional holding brake
- ⁴⁾ Maximum current consumption when DOUT0 to DOUT2 and the CAN bus are loaded

Motor temperature monitoring

Parameter	Values
Digital sensor	Normally closed contact: $R_{\text{cold}} < 500 \Omega$ $R_{\text{hot}} > 100 \text{ k}\Omega$
Analog sensor	Silicon temperature sensor, KTY series KTY81-2x0; KTY82-2x0 $R_{25} \approx 2000 \Omega$ KTY81-1x0; KTY81-2x0 $R_{25} \approx 1000 \Omega$ KTY83-1xx $R_{25} \approx 1000 \Omega$ KTY84-1xx $R_{100} \approx 1000 \Omega$

11.13.4 Motor connection data [X301 – X303]

Parameter	Values
Data for use with 48V / $T_{\text{housing max.}} = 50^{\circ}\text{C}$	
Output power	500 VA
Max. output power for 2 s	1500 VA
Output current	15 A _{eff} @ $T_{\text{PowerStage}} \leq 50^{\circ}\text{C}$ 10 A _{eff} @ $T_{\text{PowerStage}} \leq 70^{\circ}\text{C}$
Max. output current for 2 s	40 A _{eff} @ $T_{\text{PowerStage}} \leq 50^{\circ}\text{C}$ 32 A _{eff} @ $T_{\text{PowerStage}} \leq 70^{\circ}\text{C}$
Clock frequency	10 kHz / 20 kHz

11.13.5 Resolver [X2]

Parameter	Value
Suitable resolver	Industrial standard
Transformation ratio	0.5
Carrier frequency	10 kHz
Resolution	> 12 bits (typ. 15 bits)
Speed resolution	approx. 4 rpm
Absolute angle sensing accuracy	< 10'
Max. speed	16,000 rpm

11.13.6 Analog Hall encoder evaluation [X2]

Parameter	Value
Suitable Hall sensors	HAL400 (Micronas), SS495A (Honeywell) and others Type: differential analog output, $V_{CM} = 2.0 \text{ V} \dots 3.0 \text{ V}$ Signal amplitude: $4.8 V_{ss}$ differential max. ¹⁾
Resolution	> 12 bits (typ. 15 bits)
Signal detection delay	< 200 μs
Speed resolution	approx. 10 rpm
Absolute angle sensing accuracy	< 30'
Max. speed	16,000 rpm

¹⁾ Other signal levels as customized versions upon request. Please contact your local distributor.

Hiperface encoder evaluation [X2]

Parameter	Value
Suitable encoder	Stegmann Hiperface SCS / SCM60; SRS / SRM50; SKS36 For other types, please contact your local distributor.
Resolution	Up to 16 bits (depending on line count)
Signal detection delay	< 200 μs
Speed resolution	approx. 4 rpm
Absolute angle sensing accuracy	< 5'
Max. speed	6.000 rpm generell, 3.000 rpm with an encoder with 1024 lines

11.13.7 Incremental encoder evaluation [X2] – only DUET_FL 48/10 FB

Parameter	Value
Line count	32 .. 1024 lines per revolution can be parametrized
Connection level	5 V differentiell / RS422-standard
Supply feedback system	+5 V / 100 mA max.
Input impedance	$R_i \approx 1600 \Omega$
Limit frequency	$f_{\text{limit}} > 100 \text{ kHz (lines/sec)}$

Six-Step Hall sensor and block commutation [X2]

Parameter	Value
Suitable Hall sensors	Hall sensor with +5V supply, 120° phase offset, open collector or push-pull output, $i_{out} > 5 \text{ mA}$
Resolution	6 steps per electrical revolution
Signal detection delay	< 200 μs
Speed resolution	Depending on the number of pairs of poles of the motor
Max. speed	3.000 rpm in the case of a motor with two pairs of poles

11.13.8 RS232 [X1]

Parameter	Value
RS232	In accordance with RS232 specification, 9600 bits/s to 115.2 k bits/s

11.13.9 CAN-Bus [X1]

Parameter	Value
CANopen controller	TJA 1050, Full-CAN-Controller, 1M bit/s, maximum adjustable value 500 kbit/s
CANopen protocol	In accordance with DS301 and DSP402

11.13.10 Analog inputs and outputs [X1]

Parameter	Values
High-resolution analog inputs	$\pm 10\text{V}$ input range, 12 bits, differential, < 250 μs delay, input protection circuit up to 30V
Analog input: AIN0 / #AIN0	Analog input, can be used to assign current or speed setpoints. (multiple use with DIN0 and DIN1)
Analog input: AIN1 / #AIN1	Analog input, can be used to assign current or speed setpoints. (multiple use with DIN2 / DOUT1 and DIN3 / DOUT2)
Analog output: AMON0	0... 10V output range, 8-bit resolution, $f_{limit} \approx 1\text{kHz}$

11.13.11 Digital inputs and outputs [X1]

Parameter	Value	
Signal level	24V (8V...30V) active high, compliant with EN 1131-2	
Logic inputs in general	Bit 0 \ Bit 1, \ Destination selection for positioning	
DIN0	Bit 2, / 16 destinations can be selected from destination table	
DIN1	Bit 3 /	
DIN2	Bit 4 \ \ Destination group selection for positioning	
DIN3	/ 4 groups with separate positioning parameters	
DIN4	Bit 5 / (e.g. speed, accelerations, positioning mode) can be selected.	
DIN5	Bit 4 \ \ Destination group selection for positioning	
DIN6	/ 4 groups with separate positioning parameters	
DIN7	Bit 5 / (e.g. speed, accelerations, positioning mode) can be selected.	
DIN8	Control signal for positioning start	
DIN9	Limit switch input 0	
DIN10	Limit switch input 1	
DIN11	Power stage enabling in the case of a rising edge; Error acknowledgement in the case of a falling edge.	
Logic outputs in general	24V (8V...30V) active high, short-circuit-proof against GND	
DOUT0	Ready for operation	24 V, 20 mA max.
DOUT1	Can be configured as desired. Can be used as encoder output signal A (pin is used multiple times with DIN2 and AIN1).	24 V, 20 mA max.
DOUT2	Can be configured as desired. Can be used as encoder output signal B (pin is used multiple times with DIN3 and #AIN1).	24 V, 20 mA max.
DOUT3 [X3]	Holding brake	24 V, 700 mA max.

11.13.12 Incremental encoder output [X1]

Parameter	Value
Number of increments of the output	32 / 64 / 128 / 256 / 512 / 1024 lines per revolution can be programmed.
Connection level	24V / 20 mA max.
Output impedance	$R_a \approx 300 \Omega$
Limit frequency	$f_{limit} > 100 \text{ kHz (lines/sec)}$; f_{limit} depends on the cable length; data measured with $R_{Load} = 1 \text{ k}\Omega$ and $C_{Load} = 1 \text{ nF}$ (corresponds to a cable length of 5 m)

11.14. Mechanical installation

Important notes

- ❖ The DUET_FL servo positioning controller was designed for direct installation on the motor.
- ❖ Optionally it is also possible to use it separately from the motor. In this case, additional connecting cables between the motor and the DUET_FL servo positioning controller are required. These cables should be as short as possible. The maximum length is 1 m.
- ❖ Optimum cooling can be ensured if the DUET_FL servo positioning controller is mounted in a vertical position. This means that connector X1 is located on top or at the bottom.
- ❖ The maximum permissible temperature of the housing is 70°C to guarantee the specified service life of the electronic system.
- ❖ Connect the connecting cable for X1 as closely as possible to the DUET_FL servo positioning controller to increase the reliability of the cabling.
- ❖ Installation spaces:
Keep a minimum distance of 100 mm underneath and above the device to other components to ensure sufficient ventilation.

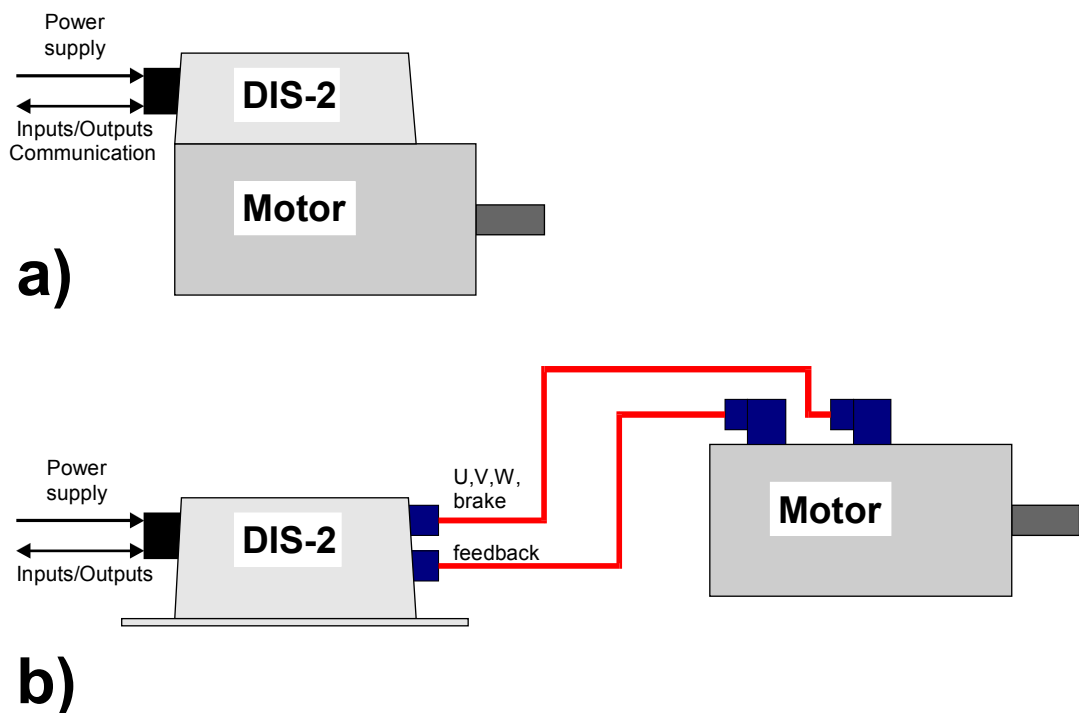

DUET_FL mounting options:

- a) Mounted directly on the motor - standard
- b) Separated from the motor - Please contact your local distributor to check whether this option is available.

Position and connection of the pin-and-socket connectors

The DUET_FL servo positioning controller has the following connections:

- ❖ X1 is the only IO connector led to the outside. It includes digital and analog inputs and outputs, the power supply, the CANopen interface and some debug signals.
- ❖ X2 is used to connect the angle encoders. This connector supports the following angle encoders:
 - Resolvers
 - Analog Hall sensors (upon request)
 - Stegmann HIPERFACE
 - Digital Hall sensors (Six-Step encoders)
- ❖ X3 is used to connect the holding brake.
- ❖ X301, X302, X303 are the connectors for the three motor phases U, V and W.
- ❖ X8 is an extension port for future technology modules.



Figure 30: Arrangement of DUET_FL pin-and-socket connectors - top view of electronics module

Housing dimensions

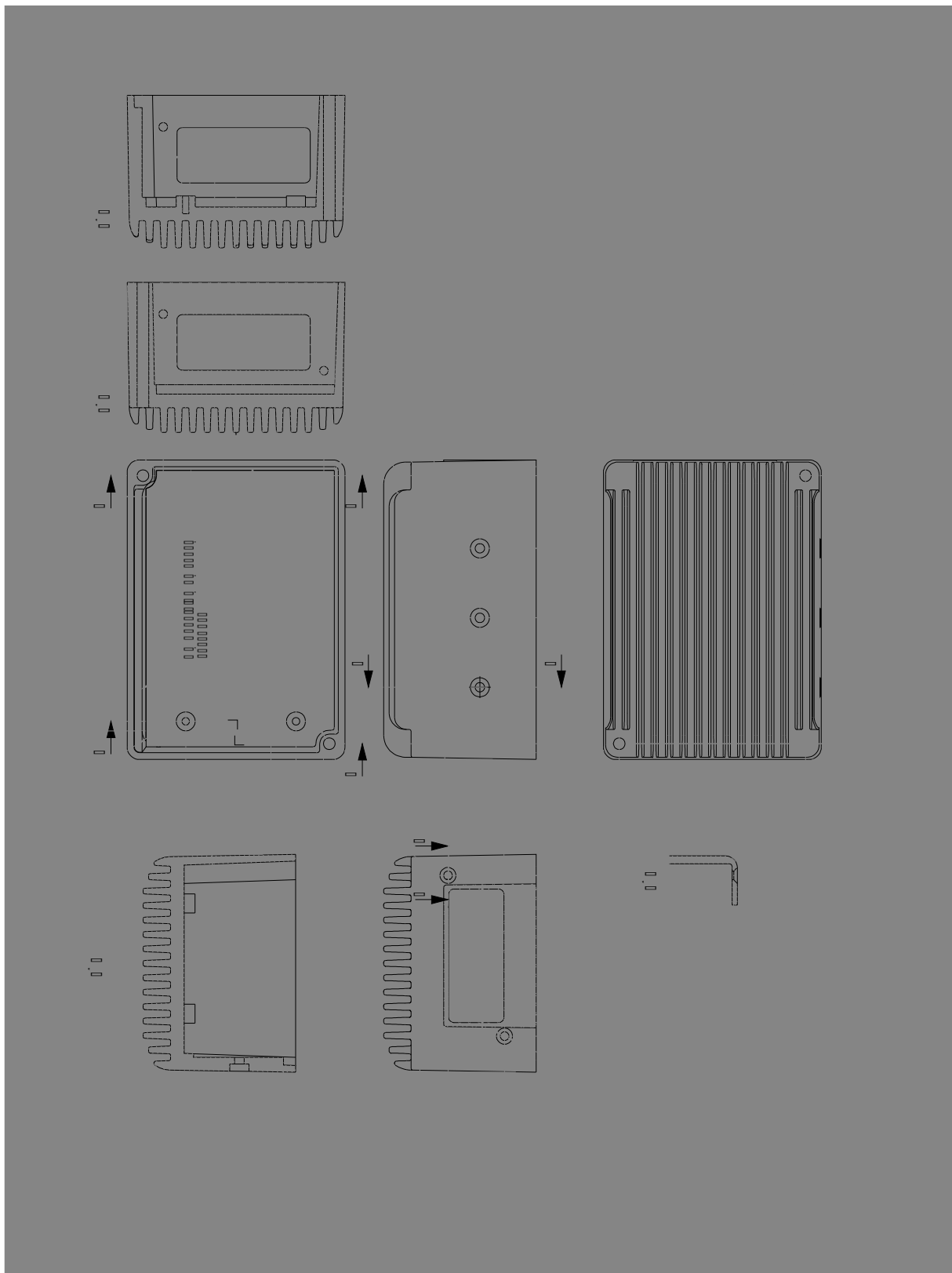

Figure 31: Housing dimensions

Installation

The servo positioning controller can be mounted directly on the motor using a seal. The mounting surface on the motor should be plain and smooth with a circumferential groove to protect the installation against splash water. An IP67 class of protection is possible with a good mechanical design.

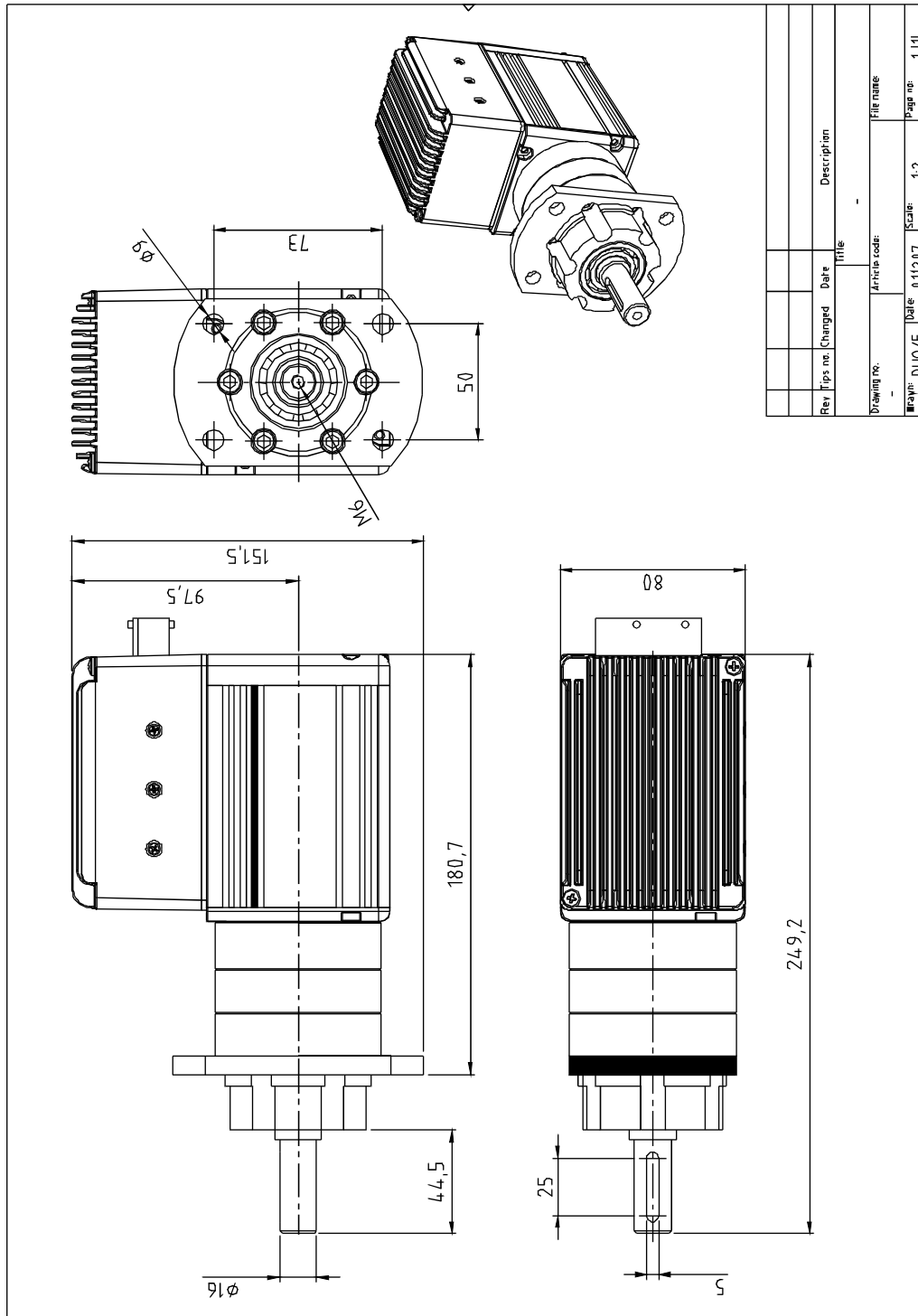

Figure 32: DUET_FL application example - Synchronous servo motor in the power range of 500 W with a DUET_FL servo positioning controller and a gearbox for a steering application.

Connectors at the DUET_FL 48/10

Connection: Power supply and I/O [X1]

- ❖ Configuration on the device: AMP Junior Timer 1-963215-1
- ❖ Mating connector [X1]: AMP 1-963217-1 / contacts: 929938-1

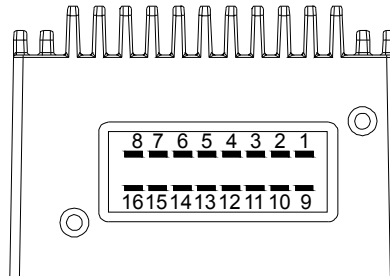

Figure 33: Numbered pins of X1 DUET_FL 48/10

Table 27: Pin assignment of connector [X1]

Pin no.	Name	Value	Specification
1	DIN9	0 V...24 V	Digital input: Power stage activation
2	DIN7	0 V...24 V	Digital input: Limit switch 0 (blocks n > 0)
3	CANHI (DIN4)	0 V...24 V	CAN high (Digital input: Positioning group selector bit 0)
4	AIN1 (DIN2) ((DOUT1))	-10 V...10 V (0 V...24 V) ((0 V...24 V))	Analog input 1: Differential analog input with #AIN1 (Digital input: Positioning destination selector bit 2) ((Digital output: Freely programmable / encoder output track A))
5	AIN0 (DIN0)	-10 V...10 V	Analog input 0: Differential analog input with #AIN0 (Digital input: Positioning destination selector bit 0)
6	RxD	+/-10 V	Reception signal, RS232 specification
7	GND	0 V	Shared ground potential for the DC bus voltage and the 24V logic supply.
8	ZK+	+48 V / 15 A _{nom.}	Intermediate circuit supply (DC bus)
9	DOUT0 / READY	0 V / 24 V	Ready for operation
10	DIN8	0 V...24 V	Digital input: Limit switch 1 (blocks n < 0)
11	CANLO (DIN5)	0 V...24 V	CAN low (Digital input: Positioning group selector bit 1)
12	#AIN1 (DIN3) ((DOUT2))	-10 V...10 V (0 V...24 V) ((0 V...24 V))	Negative analog input 1: Differential analog input with AIN1 (Digital input: Positioning destination selector bit 3) ((Digital output: Freely programmable / encoder output track B))
13	#AIN0 (DIN1)	-10 V...10 V	Negative analog input 0: Differential analog input with AIN0 (Digital input: Positioning destination selector bit 1)
14	TxD	+/-10 V	Transmission signal, RS232 specification
15	AMON0 (DIN6)	0 V...10 V; 2 mA (0 V...24 V)	Analog monitor 0 (Digital input: Positioning start)
16	+24V Logik	+24 V / I _{Logik} = 200 mA...1000 mA	24 V power supply for the internal logic and the IOs. Shared ground with the intermediate circuit (DC bus)

11.14.1 Connection: Angle encoder [X2]

- ❖ Configuration on the device: JST No. B16B-PHDSS
- ❖ Mating connector [X2]: JST No. PHDR-16VS / contacts: JST No. SPHD-002T-P0.5

X2

15	16
13	14
11	12
9	10
7	8
5	6
3	4
1	2

Figure 34: Angle encoder connector

Table 28: Pin assignment of connector [X2]

Pin no.	Name	Value	Specification
1	GND	0 V	Reference potential for incremental encoder / analog Hall sensors / Stegmann Hiperface encoder
2	GND	0 V	Reference potential for Hall sensor and / or motor temperature sensor
3	+5V	+5 V / 100 mA	+5 V supply for linear Hall sensors or incremental encoder
4	+5V	+5 V / 100 mA	+5 V supply for Hall sensors
5	COS A	1.5 V _{RMS,diff} / R _i > 10 kΩ	Resolver: Connection to resolver signal S1 Others: Connection to incremental encoder track A
6	HALL_U	0 V / 5 V R _i = 5 kΩ	Phase U Hall sensor for commutation Input with 4.7 kΩ pull-up at +5 V
7	#COS #A	1.5 V _{RMS,diff} / R _i > 10 kΩ	Resolver: Connection to resolver signal S3 Others: Connection to incremental encoder track #A
8	HALL_V	0 V / 5 V R _i = 5 kΩ	Phase V Hall sensor for commutation Input with 4.7 kΩ pull-up at +5 V
9	SIN B	1.5 V _{RMS,diff} / R _i > 10 kΩ	Resolver: Connection to resolver signal S2 Others: Connection to incremental encoder track B
10	HALL_W	0 V / 5 V R _i = 5 kΩ	Phase W Hall sensor for commutation Input with 4.7 kΩ pull-up at +5 V
11	#SIN #B	1.5 V _{RMS,diff} / R _i > 10 kΩ	Resolver: Connection to resolver signal S4 Others: Connection to incremental encoder track #B
12	MTEMP	0 V / 3.3 V R _i = 2 kΩ	Motor temperature sensor, normally-closed contact, PTC or analog sensor of KTY series; connected to GND
13	REF N	3 V _{RMS,diff} , max. 50 mA _{RMS}	Resolver: Connection to resolver signal R1 Others: Connection to incremental encoder track N / DATA
14	+12V	+12 V / 100 mA	+12 V power supply for Stegmann Hiperface encoder
15	#REF #N	3 V _{RMS,diff} , max. 50 mA _{RMS}	Resolver: Connection to resolver signal R2 Others: Connection to incremental encoder track #N / #DATA
16	n.c.	-	-

Connection: Motor [X301 – X303]

- ❖ Configuration on the device: 6.3 mm FAST-ON male
- ❖ Mating connector [X301 – X303]: 6.3 mm FAST-ON female (insulated externally)

**Figure 35: Motor cable connection****Table 29: Pin assignment of connector [X301 – X303]**

X30x	Name	Value	Specification
X301	PHASE_U	3 x 0 V...48 V	Connection of the three motor phases
X302	PHASE_V	15 A _{RMS,nom}	
X303	PHASE_W	40 A _{RMS,max} 0 Hz...200 Hz	

11.14.2 Connection: Holding brake [X3]

- ❖ Configuration on the device: JST No. B02B-XASK-1
- ❖ Mating connector [X3]: JST No. XAP-02V-1 / contacts: JST No. SXA-001T-P0.6

**Figure 36: Holding brake connection****Table 30: Pin assignment of connector [X3]**

Pin no.	Name	Value	Specification
1	DOUT3	0 V / 24 V max. 700 mA	Digital output: (high active) for the holding brake, internal supply via the 24 V logic supply.
2	GND	0 V	Reference potential for the holding brake

Connection: Extension port [X8]

- ❖ Configuration on the device: 2 x 8 RM 2.54 mm female
- ❖ Mating connector [X8]: 2 x 8 RM 2.54 mm male

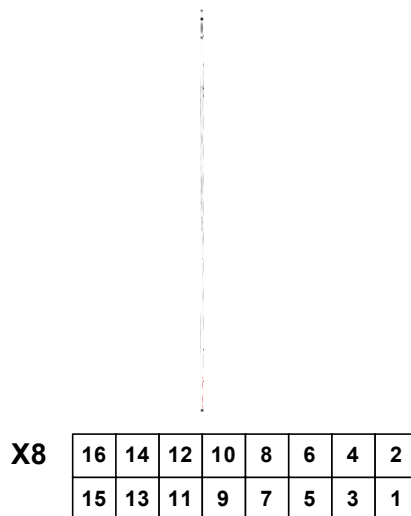
**Figure 37: Technology module connection****Table 31: Pin assignment of connector [X8]**

Pin no.	Name	Value	Specification
1	GND	All signals with 3.3 V CMOS logic level	Reference potential
2	+3.3 V		Technology module power supply 100 mA max. (together with 5 V)
3	MOSI		SPI Serial Master Output
4	SCLKB		SPI Serial Clock (20 MBit/s max.)
5	MISO		SPI Serial Master Input
6	#SS		SPI Slave Select
7	#IRQA		IO / interrupt signals of the DSP
8	#IRQB		
9	#RESET		RESET-Signal (3.3V-RESET-Controller)
10	CLK40		System clock of the DSP
11	AN1		Optional analog inputs of the DSP (0 V...3.3 V)
12	AN5		
13	RxD		Optional asynchronous serial interface (3.3 V level, 115 kBit/s max.)
14	TxD		
15	GND		Reference potential
16	+5 V		Technology module power supply 100 mA max. (together with 3,3 V)

Connectors at the DUET_FL 48/10 IC

Connection: Power supply and I/O [X1]

- ❖ Configuration on the device: Phoenix PLUSCON - VARIOCON with a total of 18 contacts
- ❖ Mating connector [X1]: Phoenix PLUSCON – VARIOCON kit,
comprising:
 - 1x VC-TFS2
 - 2x VC-TFS8
 - 1x VC-TR2/3M
 - 1x VC-MEMV-T2-Z
 - 1x VC-EMV-KV-PG21-(11.5-15.5/13.5)
 Dimensions approx. L x W x H = 86 mm x 80 mm x 32 mm

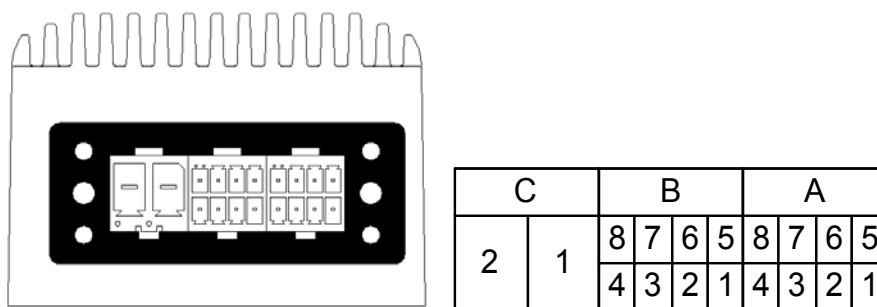

Figure 38: Numbered pins of [X1] DUET_FL 48/10 IC

Table 32: Pin assignment of connector [X1]

Pin no.	Name	Value	Specification
A1	DOUT0 / READY	0 V / 24 V	Ready for operation
A2	DIN8	0 V...24 V	Digital input: Limit switch 1 (blocks n < 0)
A3	CANLO (DIN5)	0 V...24 V	CAN low (Digital input: Positioning group selector bit 1)
A4	#AIN1 (DIN3) ((DOUT2))	-10 V...10 V (0 V...24 V) ((0 V...24 V))	Inv. analog input 1: Differential analog input with AIN1 (Digital input: Positioning destination selector bit 3) ((Digital output: Programmable / encoder output track B))
A5	DIN9	0 V...24 V	Digital input: Power stage activation
A6	DIN7	0 V...24 V	Digital input: Limit switch 0 (blocks n > 0)
A7	CANHI (DIN4)	0 V...24 V	CAN high (Digital input: Positioning group selector bit 0)
A8	AIN1 (DIN2) ((DOUT1))	-10 V...10 V (0 V...24 V) ((0 V...24 V))	Analog input 1: Differential analog input with #AIN1 (Digital input: Positioning destination selector bit 2) ((Digital output: Programmable / encoder output track A))
B1	#AIN0 (DIN1)	-10 V...10 V	Inv. analog input 0: Differential analog input with AIN0 (Digital input: Positioning destination selector bit 1)
B2	TxD	+/-10 V	Transmission signal, RS232 specification
B3	AMON0	0 V...10 V; 2 mA	Analog monitor 0
B4	GND	0 V	Reference potential for the control signals
B5	AIN0 (DIN0)	-10 V...10 V	Analog input 0: Differential analog input with #AIN0 (Digital input: Positioning destination selector bit 0)
B6	RxD	+/-10 V	Reception signal, RS232 specification

B7	DIN6	0 V...24 V	Digital input: Positioning start
B8	+24V Logik	+24 V / $I_{\text{Logik}} = 200 \text{ mA} \dots 1000 \text{ mA}$	24 V power supply for the internal logic and the IOs. Shared ground with the intermediate circuit (DC bus)
C1	GND	0 V	Shared ground potential for the intermediate circuit voltage (DC bus voltage) and the 24V logic supply.
C2	ZK+	+48 V / 15 A _{nom.}	Intermediate circuit supply (DC bus)



The X1 interface of the DUET_FL IC is compatible with the interface of the DUET_FL. The signals AMON0 and DIN6 were separated as there were still some free pins.

11.14.3 Connection: Motor, encoder, brake, extensions

The connectors for the motor phases [X301 – X303], the holding brake [X3], the angle encoder [X2] and the extension port [X8] are compatible with the DUET_FL 48/10. Information concerning the connection and the pin assignment of these connectors can be found in the corresponding sub-sections *Connectors at the DUET_FL 48/10* of the appendix.

Connectors at the DUET_FL 48/10 FB

Connection: Power supply and I/O [X1]

- ❖ Configuration on the device: Phoenix PLUSCON - VARIOCON with a total of 18 contacts
- ❖ Mating connector [X1]: Phoenix PLUSCON – VARIOCON kit, comprising:
 - 1x VC-TFS2
 - 2x VC-TFS8
 - 1x VC-TR2/3M
 - 1x VC-MEMV-T2-Z
 - 1x VC-EMV-KV-PG21-(11.5-15.5/13.5)
 Dimensions approx. L x W x H = 86 mm x 80 mm x 32 mm

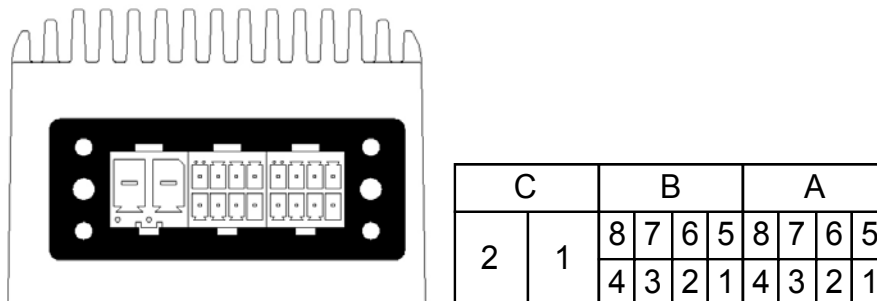

Figure 39: Numbered pins of [X1] DUET_FL 48/10 FB

Table 33: Pin assignment of connector [X1]

Pin no.	Name	Value	Specification
---------	------	-------	---------------

A1	DOUT0 / READY	0 V / 24 V	Ready for operation
A2	DIN8	0 V...24 V	Digital input: Limit switch 1 (blocks n < 0)
A3	DIN5	0 V...24 V	Digital input: Positioning group selector bit 1
A4	#AIN1 (DIN3)	-10 V...10 V (0 V...24 V)	Inv. analog input 1: Differential analog input with AIN1 or (Digital input: Positioning destination selector bit 3)
A5	DIN9	0 V...24 V	Digital input: Power stage activation
A6	DIN7	0 V...24 V	Digital input: Limit switch 0 (blocks n > 0)
A7	DIN4	0 V...24 V	Digital input: Positioning group selector bit 0
A8	AIN1 (DIN2)	-10 V...10 V (0 V...24 V)	Analog input 1: Differential analog input with #AIN1 or (Digital input: Positioning destination selector bit 2)
B1	#AIN0 (DIN1)	-10 V...10 V	Inv. analog input 0: Differential analog input with AIN0 (Digital input: Positioning destination selector bit 1)
B2	DOUT2	0 V...24 V	Digital Output Programmable / encoder output track B
B3	AMON0	0 V...10 V; 2 mA	Analog monitor 0
B4	GND	0 V	Reference potential for the control signals
B5	AIN0 (DIN0)	-10 V...10 V	Analog input 0: Differential analog input with #AIN0 (Digital input: Positioning destination selector bit 0)
B6	DOUT1	0 V...24 V	Digital Output Programmable / encoder output track A
B7	DIN6	0 V...24 V	Digital input: Positioning start
B8	+24V Logik	+24 V	24 V power supply for the internal logic and the IOs.
C1	GND	0 V	Shared ground potential for the intermediate circuit voltage (DC bus voltage) and the 24V logic supply.
C2	ZK+	+48 V / 15 A _{nom.}	Intermediate circuit supply (DC bus)



The X1 interface of the DUET_FL FB is to a large degree compatible with the one of the DUET_FL IC.

The double utilization of the inputs and outputs has been reduced to a large degree: DOUT1 and DOUT2 as well as DIN4 and DIN5 are now available in all operating modes.

Connection: Motor, encoder, brake, extensions

The connectors for the motor phases [X301 – X303], the holding brake [X3], the angle encoder [X2] and the extension port [X8] are compatible with the DUET_FL 48/10. Information concerning the connection and the pin assignment of these connectors can be found in the corresponding sub-sections *Connectors at the DUET_FL 48/10* of the appendix.

11.18.3 Brake resistance connection [X304 – X305]

- ❖ Configuration on the device: 2.8 mm FAST-ON female
- ❖ Mating connector [X304, X305]: 2.8 mm FAST-ON male (insulated externally)

- ❖ Configuration brake resistance: $R_{BR} \geq 4,7 \Omega / P_{nom} = 100 W$
z.B: metallux PLR 250 5R
 R_{BR} connect between [X304] und [X305]

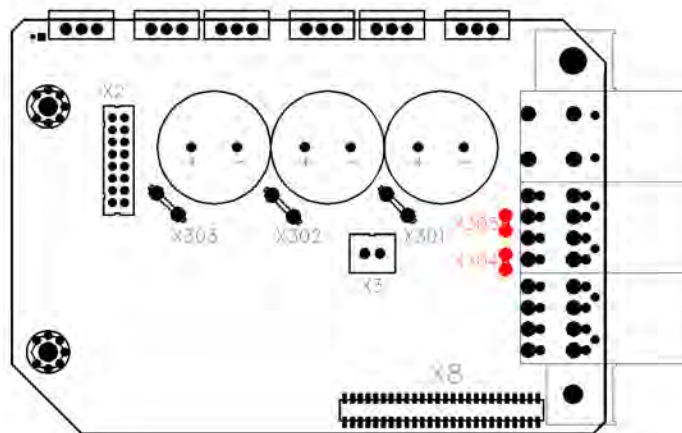

Figure 40: Brake resistance connection

Table 34: Pin assignment of connector [X304], [X305]

X30x	Name	Value	Specification
X304	ZK+	+48 V / 15 A _{nom.}	Intermediate circuit supply (DC bus)
X305	BR-CHOP	0 V / 48 V	Connection to brake resistance transistor

Connection: CAN bus [X401] and [X402]

❖ Configuration on the device: [X401] M12 flush-type plug, 5-pin type, A-coded
[X402] M12 flush-type socket, 5-pin type, A-coded

❖ Position: [X401] front - centre
[X402] front - left

Mating connector [X401]: Assembled M12 bus cable, e.g. made by Phoenix, one end male connector, one end female connector, prefabricated lengths, order name: SAC-5P-MS/xxx-920/FS SCO, xxx defines the length in [m]. The following lengths are available:
xxx = 0.3 / 0.5 / 1.0 / 2.0 / 5.0 / 10.0 / 15.0

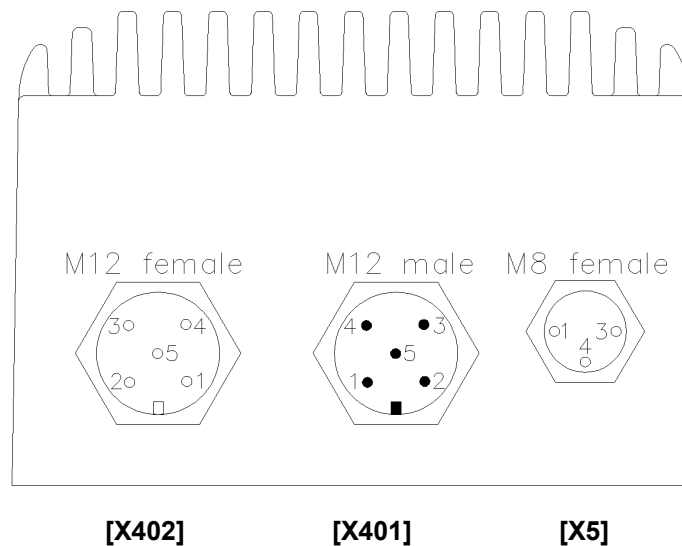

Figure 41: Position and numbered pins [X401], [X402] and [X5] at DUET_FL 48/10 FB

Table 35: Pin assignment of connector [X401] and [X402]

Pin no.	Name	Value	Specification
1	Shield	PE	Contact for cable shield, in the DUET_FL connected with the housing
2	--	-	Not used
3	CAN_GND	0 V	Reference potential for the CAN bus, internally connected with the common reference potential for the intermediate circuit and the logic system
4	CANHI	0 V 5 V	Signal CAN_H according to CAN bus specification
5	CANLO	0 V 5 V	Signal CAN_L according to CAN bus specification

11.18.5 Connection: Serial parameterization interface [X5]

- ❖ Configuration on the device: M8 flush-type socket, 3-pin type
- ❖ Position: front – right, see
- ❖ Mating connector: M8 mating connector for free configuration,
e.g. Phoenix SACC-M8MS-3CON-M-SH

Table 36: Pin assignment of connector [X5]

Pin no.	Name	Value	Specification
1	RxD	+/-10 V	Reception signal, RS232 specification
3	TxD	+/-10 V	Transmission signal, RS232 specification
4	GND	0 V	Reference potential for the serial interface, internally connected with the common reference potential for the intermediate circuit and the logic system

Table 37: Pin assignment to set up an RS232 adapter cable for connection to a PC/notebook

X5 pin assignment at DUET FL 48/10 FB		Dsub 9 connector (pin) for connection to a PC		Specification
Pin no.	Name	Pin no.	Name	Specification
1	RxD	3	TxD_PC	Reception signal, RS232 specification
3	TxD	2	TxD_PC	Transmission signal, RS232 specification
4	GND	5	GND	Reference potential for the serial interface, internally connected with the common reference potential for the intermediate circuit and the logic system
-	Shield	-	Shield	Connect the cable shield on both sides of the connector housing

Connection: Extension port [X8]

- ❖ Configuration on the device: 2 x 26 RM 1.27 mm Buchsenreihe
- ❖ Mating connector [X8]: 2 x 26 RM 1.27 mm Pinreihe

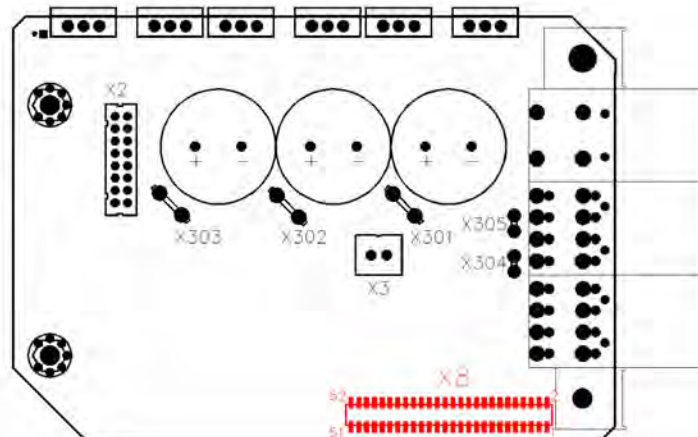

Figure 42: Position and connection technology module

Table 38 (A): Pin assignment of connector [X8]

Pin no.	Name	Value	Specification
1	--	All signals with 3.3 V CMOS logic level	Not used
2	+24 V	+ 24 V / max. 100 mA	Withdrawal of the protected logic supply of + 24 V for future applications / device variants
3	DIN8	0 V / 24 V	Digital 24 V input for limit switches, parallel to X1
4	DIN7	0 V / 24 V	Digital 24 V input for limit switches, parallel to X1
5	GND	0 V	Reference potential
6	GND	0 V	Reference potential
7	RxD	+/- 10 V	Serial interface signal RxD
8	TxD	+/- 10 V	Serial interface signal TxD
9	CANHI_NDR	0 V / 5 V	Field bus signal CAN_H before "filter"
10	CANLO_NDR	0 V / 5 V	Field bus signal CAN_L before "filter"
11	+3.3 V	3.3 V +/- 2%	Technology module power supply 100 mA max. (together with 5 V)
12	+5 V	5.0 V +/- 5%	Technology module power supply 100 mA max. (together with 3.3 V)

Continuation of the table (B): Pin assignment of connector [X8]

Pin no.	Name	Value	Specification
13	D14	All signals with 3.3 V CMOS logic level	16-bit parallel interface – data bus
14	D15		
15	D12		
16	D13		
17	D10		
18	D11		
19	D8		
20	D9		
21	D6		
22	D7		
23	D4		
24	D5		
25	D2		
26	D3		
27	D0		
28	D1		
29	A11	All signals with 3.3 V CMOS logic level	16-bit parallel interface – address bus
30	A12		
31	A9		
32	A10		
33	A7		
34	A8		
35	A5		
36	A6		
37	A3		
38	A4		
39	A1		
40	A2		
41	#DS	All signals with 3.3 V CMOS logic level	Bus control signals for access to technology modules via the data and address bus, and synchronous-serial interface for access to technology modules with an SSIO interface
42	A0		
43	#RD		
44	#WR		
45	#IRQB (SYNC)		
46	#IRQA		
47	MOSI		
48	SCLK		
49	MISO		
50	#SS		
51	GND	0 V	Reference potential
52	GND	0 V	Reference potential

Electrical installation of the DUET_FL 48/10

Connection to Power Supply and control in system

The following illustration shows a typical application with two or more DUET_FL servo positioning controllers with a connection to a 48 V intermediate circuit (DC bus) supply, to a 24 V logic supply and to a control or to a PLC.

The mains power supply with the master contactor, fuses and an EMERGENCY OFF device is not shown. The connection is described in *chapter EMERGENCY OFF / EMERGENCY STOP – terminology and standards*.

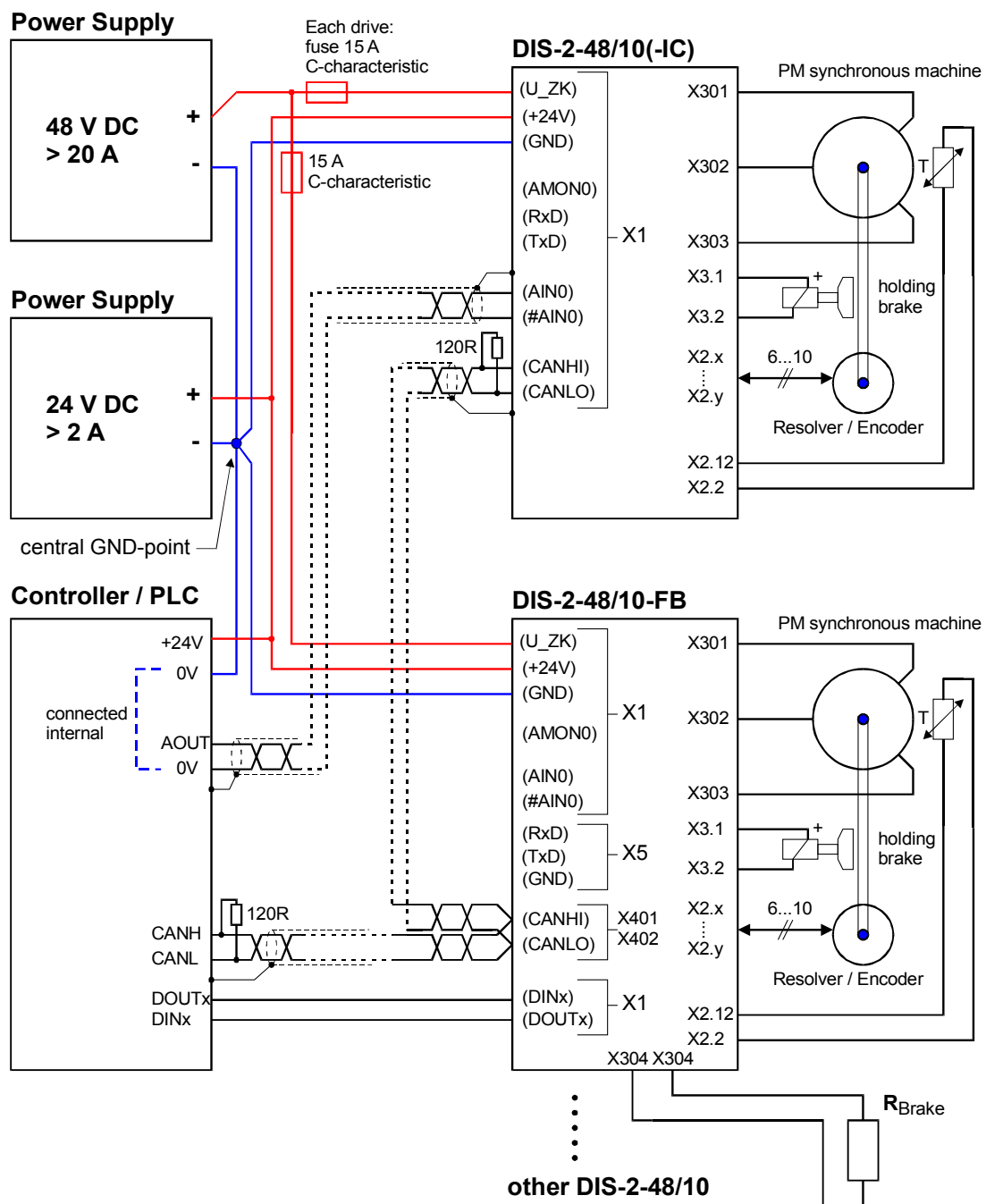

Figure 43: Connection to power supply, control and motor

The servo positioning controller is connected to the 48 V intermediate circuit (DC bus) supply and to the 24 V logic supply. A shared reference potential (GND) is used. A central star point near the power supply units for all GND connections reduces the "ground bouncing" effects between the controllers.

The motor has to be connected through the FASTONs [X301] to [X303] on the circuit board of the DUET_FL.

The DUET_FL controls an optional holding brake through connector [X3]. The encoder and the temperature sensor have to be connected through the recessed connector [X2] on the circuit board.

The DUET_FL-48/10 FB has an additional integrated brake chopper. It is therefore possible to connect the braking resistor through the FASTONs [X304] and [X305] on the circuit board as shown below right in Figure 43: Connection to power supply, control and motor. Normally, the braking resistor is installed on the mounting plate for the electronics housing.

If the analog inputs are used to assign setpoints, we recommend using shielded and twisted cables for AINx / #AINx, even if the control does not provide any differential signal. Connection of #AINx to the 0V reference potential at the control system prevents common-mode interferences which are caused by high currents flowing through the power stage and the external cables. The shield prevents the penetration of interferences and should be connected on both ends (to the housing of the DUET_FL servo positioning controller and to the housing of the control system).

The CAN bus should be cabled in the same way as the analog inputs. A terminating resistor of 120Ω / 1% has to be installed at both ends of the CAN bus network. The individual nodes of the network are always connected in line so that the CAN cable is looped through from controller to controller.

In the case of the DUET_FL 48/10 and DUET_FL 48/10 IC (above right in the picture), it may be necessary to connect two cables to one pin of connector [X1]. This is not necessary in the case of the DUET_FL 48/10 FB (below right) since there are already two connectors, [X401] and [X402], for the CAN bus.

The DUET_FL 48/10 FB has a separate connector, [X5], for the serial service interface. On all the other DUET_FL variants, it is connected through [X1].

The signals for the digital IOs DINx and DOUTx do not need a shield to protect them against interferences, but a shielded cable between the DUET_FL servo positioning controller and the control system improves the EMC behaviour through out the entire system and particularly in view of radiated interferences. At least the control signals DIN9 (controller enable) and DOUT0 (ready for operation) have to be connected between the SPC and the controller.

Make sure that the DUET_FL servo positioning controller is completely connected prior to switching on the power supply for the intermediate circuit (DC bus) and the logic system. If the power supply connections are reversed, if the power supply is too high or if the connections of the intermediate supply and the logic supply are mixed up, the DUET_FL servo positioning controller may be permanently damaged.

EMERGENCY OFF / EMERGENCY STOP – terminology and standards

In accordance with a danger analysis / risk assessment following the machinery directive 98/37/EC, EN ISO 12100, EN 954-1, and EN 1050, the machine manufacturer has to plan the safety system for the entire machine whilst taking into account all the integrated components. Among these are also electric drives. The standstill of the machine has to be initiated and ensured by the control system of the machine. This applies particularly to vertical axes without a self-locking mechanism or weight compensation.

The standard EN 954-1 subdivides the requirements placed on control systems into five categories graduated according to the level of risk (see Table 10).

Table 39: Description of the requirements to be met for the categories in accordance with EN 954-1

Category ¹⁾	Summary of requirements	System behavior ²⁾	Principles to achieve safety
B	Safety-related parts of control systems and/or their protective equipments, as well as their components, shall be designed, constructed, selected, assembled and combined in accordance with relevant standards to that they can withstand the expected influence.	The occurrence of a fault can lead to the loss of the safety function.	Mainly characterized by selection of components.
1	The requirements of category B shall apply. Well-tried components and well-tried safety principles shall be used.	The occurrence of a fault can lead to the loss of the safety function but the probability of occurrence is lower than for category B.	
2	The requirements of category B and the use of well-tried safety principles shall apply. The safety function must be checked at suitable intervals by the control system of the machine.	The occurrence of a fault can lead to the loss of the safety function between the checks. The loss of a safety function is detected by the checks.	
3	The requirements of category B and the use of well-tried safety principles shall apply. Safety-relevant parts must fulfill the following requirements: - It must be ensured that a single fault in any of the parts does not lead to a loss of the safety function. - The single fault is detected whenever this is reasonably practical.	When a single fault occurs, the safety function is always performed. Some but not all faults will be detected. Accumulation of undetected faults can lead to the loss of the safety function.	Mainly characterized by structure
4	The requirements of category B and the use of well-tried safety principles shall apply. Safety-relevant parts must have a redundant design; permanent self-checking; complete fault detection!	When faults occur, the safety function is always performed. Faults will be detected in time to prevent the loss of the safety function.	

- 1) The categories are not intended to be used in any given order or in any given hierarchy in respect of safety requirements.
- 2) The risk assessment will indicate whether the total or partial loss of the safety function(s) arising from faults is acceptable.

The standard EN 60204-1 describes possible actions for emergency situations and defines the terms EMERGENCY OFF and EMERGENCY STOP (see Table 11)

Table 40: EMERGENCY OFF and EMERGENCY STOP according to EN 60204-1

Action	Definition (EN 60204-1)	Emergency situation
EMERGENCY OFF	This intervention is used to achieve electrical safety in an emergency situation by disconnecting the electrical power to a complete system or installation or part of it.	An EMERGENCY OFF has to be used if there is a risk of electric shock or another risk caused by electricity.
EMERGENCY STOP	This intervention is used to achieve functional safety in an emergency situation by stopping a machine or moving parts.	An EMERGENCY STOP is used to stop a process or a movement which has become hazardous.

As a consequence, an EMERGENCY OFF device requires the disconnection of the power supply through at least one power contactor, whereas an EMERGENCY STOP can be performed without disconnecting the power supply.

For stopping the drives, EN 60204-1 describes three stop categories that can be used depending on a risk analysis. (see Table 12). The next section includes a connection suggestion that allows to realize the stop categories 0 and 1.

Stop category 2 is not suitable for an EMERGENCY OFF or an EMERGENCY STOP. Stop category 2 is often realized by the control by setting the setpoint to zero. In order to comply with the requirements of stricter safety categories, additional external monitoring devices have to be used!

Table 41: Stop categories

Stop category 0	Uncontrolled stop. Stopping by immediate disconnection from power.	EMERGENCY OFF or EMERGENCY STOP
Stop category 1	Controlled stop. Power is disconnected when the machine has come to a standstill.	EMERGENCY STOP
Stop category 2	Controlled stop. Power is not disconnected when the machine is at a standstill.	Not suitable for EMERGENCY OFF or EMERGENCY STOP

EMERGENCY OFF / EMERGENCY STOP wiring examples

Figure 8 on the next page shows a realization example for a system that comprises one or several DUET_FL units, power supply units with a mains power connection, a control system and switching elements to realize the EMERGENCY STOP function in accordance with EN 60204-1, stop category 1.

The system comprises the following components:

S1	Mains power switch
F1	Fuse for the 24 V logic supply The logic supply is supplied with 230 V AC on the primary side through L1 and N.
Q1	3-phase circuit breaker. The rating depends on the number of DUET_FL units and on the requirements of the power supply unit.
K1	Power contactor
F2	Fuse in the +48 V power stage supply system. Every DUET_FL needs a separate fuse.
ECS	EMERGENCY STOP switching device. A safety chain is connected to this device.
PLC	An SPC or an industrial PC that is used to control the system.

Under normal operating conditions, the switching contacts in the ECS are closed. The SPC actuates the power contactor K1 through a digital output.

Every DUET_FL unit signals to the SPC that it is ready for operation via DOUT0. Thus, every DUET_FL unit requires one digital input at the SPC. The SPC uses a second digital output to control the controller enabling signal DIN9 of all the connected DUET_FL units. This common enabling signal is also fed through the ECS. In the event of an error (EMERGENCY OFF, EMERGENCY STOP), the intermediate circuit supply and the controller enabling signal will be disconnected.

The selection of a suitable ECS depends on the actual application. In the simplest case, no ECS is used. Instead, multipolar switching contacts are used in the safety chain.

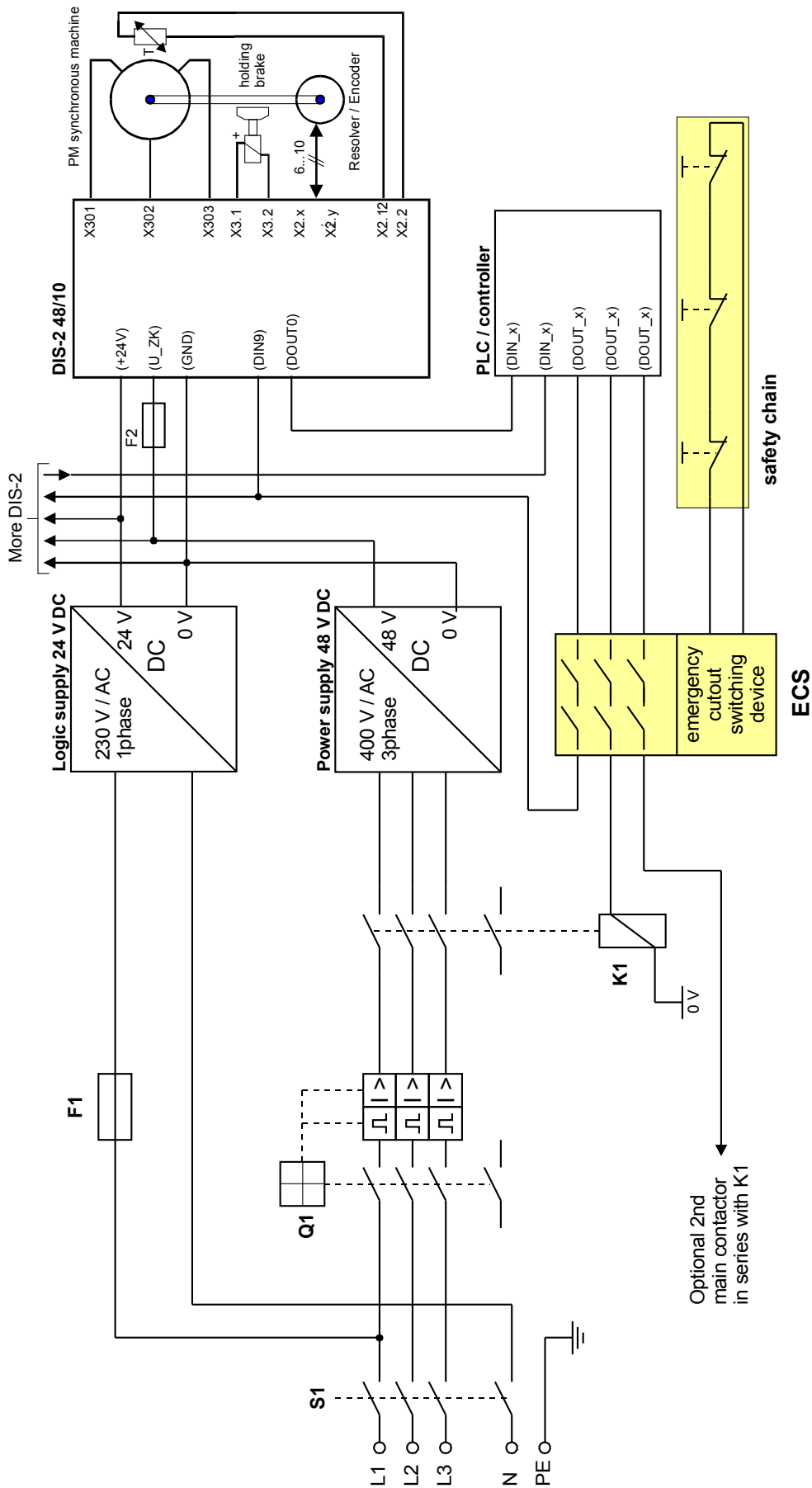

Figure 44: Wiring example for the power supply and EMERGENCY OFF / EMERGENCY STOP

EMERGENCY OFF (stop category 0):

In an EMERGENCY OFF situation, the safety chain is activated. Depending on the actual machine, the safety chain comprises various elements, e.g. EMERGENCY OFF buttons, key-operated switches, start buttons etc. The ECS also checks the safety chain for faults, such as line breaks, short-circuits etc. In the event of an error or if the chain is open, it ensures that K1 is switched off safely. The mains power supply for the 48 V power supply unit will be interrupted.

The connection example shown may differ from the actual connection depending on the required safety category:

The connection example shown in Figure 44 → fulfils the requirements of EN 954, safety category 1

The connection example shown in Figure 44 may be extended by a second power contactor and an ECS unit in accordance with EN 954, safety category 3 → fulfils the requirements of EN 954, safety category 3.



After the disconnection of the mains power supply, there is still some residual energy in the intermediate circuit capacitors of the 48 V power supply unit and of the DUET_FL. The elimination of this energy by internal discharging resistors in the DUET_FL and in the power supply unit takes some time (duration: > 5 minutes).

With $U_{DC\ bus} = 50\ V$, the electrical energy per DUET_FL unit is: $P_{C, DC\ bus} \approx 0.7\ Ws$

In applications where this is not acceptable, the intermediate circuit has to be quickly discharged with the help of an additional contact connected to K1 and a suitably rated discharging resistor.

EMERGENCY STOP (stop category 1):

An additional contact set in the ECS also disconnects the controller enabling signal from the DUET_FL.

The drives decelerate along the quick-stop ramp to zero speed. Then the DUET_FL switches the output stage off.

The connection example shown may differ from the actual connection depending on the required safety category:

The connection example shown in Figure 44 → fulfils the requirements of EN 954, safety category 1

The connection example shown in Figure 44 as well as drives with a holding brake, delayed disconnection of the 24 V logic supply of the DUET_FL through the ECS. ECS in accordance with EN 954, safety category 3 → fulfils the requirements of EN 954, safety category 3.

**DANGER !**

The EMERGENCY OFF and EMERGENCY STOP wiring described herein is only one possible realization example. Depending on the application, broader or completely different regulations concerning the design of these functions may apply.

The machine manufacturer or the project manager has to gather all the necessary information concerning the actual safety requirements, work out a safety concept for the system and then select the connection and the components accordingly.

11.20 Notes concerning safe and EMC-compliant installation

Definitions and terminology

Electromagnetic compatibility (EMC) or electromagnetic interference (EMI) includes the following requirements:

- ❖ Sufficient **immunity** of an electrical installation or an electrical device against external electrical, magnetic or electromagnetic interferences via cables or the environment.
- ❖ Sufficiently small **unwanted emission** of electrical, magnetic or electromagnetic interference of an electrical installation or an electrical device to other devices in the vicinity via cables or through the environment.

General information concerning EMC

The interference emission and interference immunity of a servo positioning controller always depend on the overall drive concept consisting of the following components:

- ❖ Power supply
- ❖ Servo positioning controller
- ❖ Motor
- ❖ Electromechanical system
- ❖ Configuration and type of wiring
- ❖ Superimposed control system



DUET_FL servo positioning controllers are certified in accordance with product standard EN 61800-3 for electrical drives.

In most cases no external filter measures are required (see below).

The declaration of conformity for the EMC directive 89/336/EEC is available from the manufacturer.

11.20.1 EMC ranges: First and second environment

Proper installation and wiring of all connecting cables provided, the DUET_FL servo positioning controllers fulfil the requirements of product standard EN 61800-3. This standard no longer refers to "classes", but to so-called environments. The first environment includes mains supply networks supplying residential buildings. The second environment includes mains supply networks exclusively supplying industrial buildings.

Connection between the DUET_FL and the motor

If the DUET_FL servo positioning controller is mounted directly on the motor, the cables are located inside the housing. They are only a few cm long. In this case, shielding is not necessary.

If you want to mount the motor and the DUET_FL separately, please observe the following wiring instructions:

- ❖ Use shielded cables only. The encoder cables should have an internal and an external shield.
- ❖ Use separate cables for the motor phases and the angle encoder.
Alternative: Use a combined cable for the motor and the angle encoder, but with separate shields.
- ❖ Connect all (external) shields with the housing of the DUET_FL controller.
- ❖ Connect the shield of the motor cable with the motor housing.
- ❖ Connect the internal shield of the encoder cable to PIN 1 of [X2].
- ❖ Make sure to set up a "good" PE connection between the motor and the DUET_FL controller.



A "good" PE connection has only a low impedance even in the case of very high interference frequencies. An optimum PE connection can be obtained by mounting the DUET_FL controller directly on the motor. If you want to mount the DUET_FL controller and the motor separately, make sure to mount them on the same (metal) part of the machine. In this case, the surface of the machine part should be made of uncoated aluminium or galvanized sheet metal!

11.20.2 Connection between the DUET_FL and the power supply unit

- ❖ Use cable with a sufficient cross-section, to reduce "ground bouncing" effects on the DC bus supply (intermediate circuit supply):
2.5 mm² (AWG13) should be sufficient for a cable length of up to 5 m between the power supply unit and the DUET_FL controller.
- ❖ Use a star-shaped cable layout (see *chapter Connection to Power Supply and control in system*) if you want to connect several DUET_FL controllers to one power supply unit. The star point of the reference potential should be as close as possible to the power supply unit.
- ❖ The power supply unit should have a Y-capacitor of at least 100 nF between the DC bus voltage (intermediate circuit voltage) and PE as well as between GND and PE.
- ❖ Make sure to set up a "good" PE connection between the DUET_FL controller and the power supply unit. It is important to ensure a good feedback of the high-frequency leakage currents generated by the clocked power stage in the DUET_FL controller combined with the winding capacity between the motor phase and PE in the motor.
- ❖ To make sure that the radiation limits are complied with, use a shielded cable.

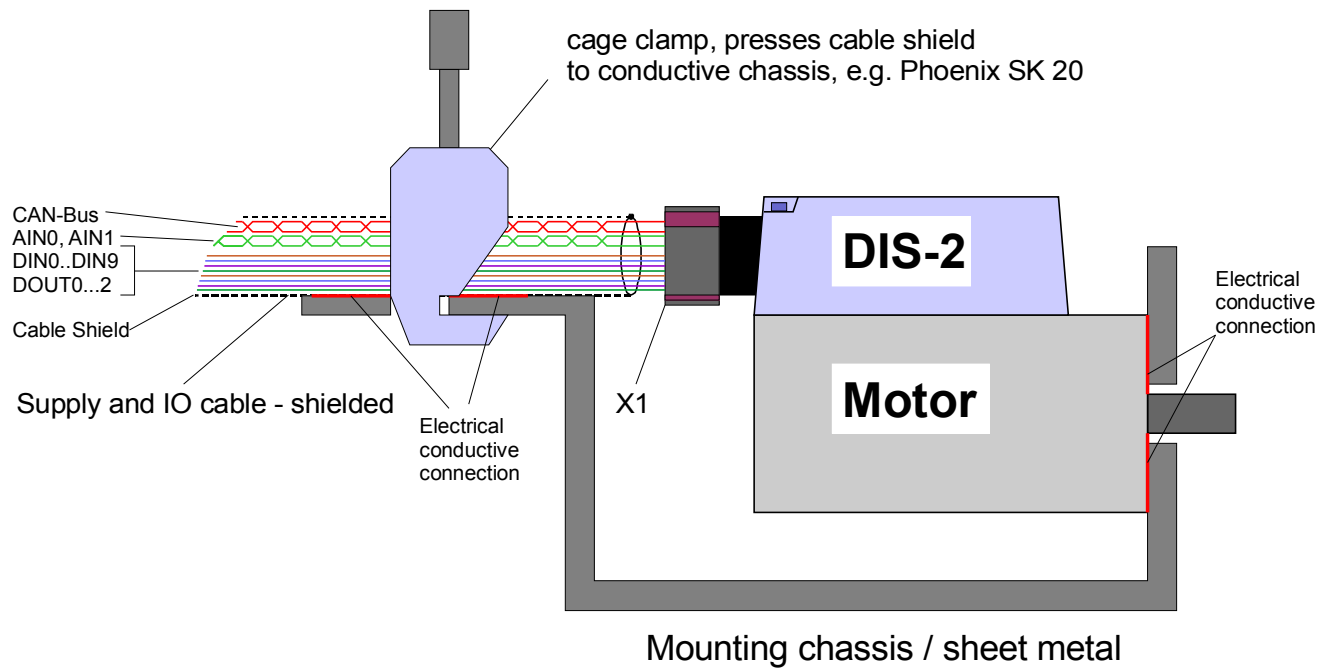

Figure 45: Connection of the DUET_FL to the power supply unit, shield connection on the chassis

If possible, connect the cable shield to the machine part on which the DUET_FL servo positioning controller is mounted, as shown in Figure 45. Remove the cable sheath only in the area of the shield terminal. Then press the open cable shield onto the machine part using a shield terminal. The selection of the shield terminal depends on the mechanical design. The suggested SK 20 D shield terminal made by Phoenix is rated for a maximum metal sheet thickness of 2 mm. A conductive and flat connection between the motor and the machine part and between the machine and the cable shield has to be ensured.

If this type of shield connection is not possible for design reasons, you can also connect the cable shield under the fastening screw of the DUET_FL using a suitable cable lug (see Figure 46).

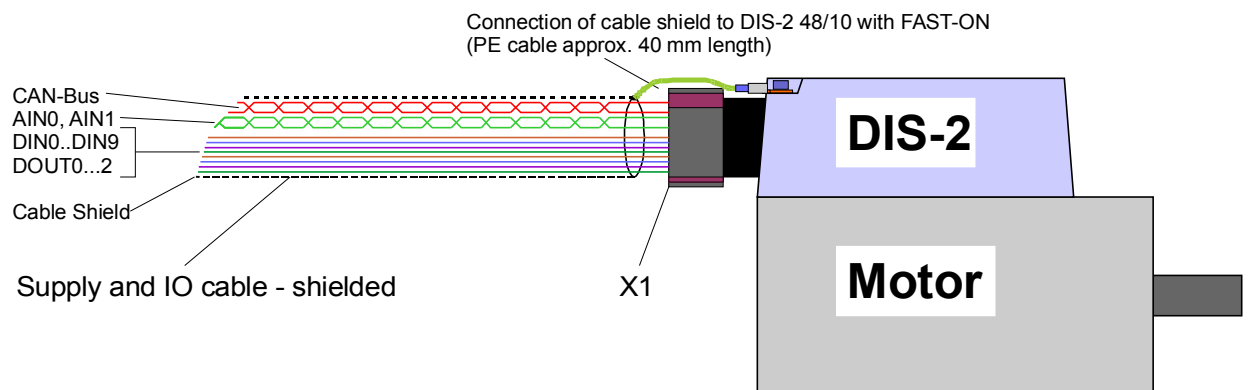

Figure 46: Connection of the DUET_FL to the power supply unit, shield connection via cable

The device variants DUET_FL 48/10 IC and DUET_FL 48/10 FB use Pluscon Variocon connectors made by Phoenix for [X1]. If the recommended metal connector housings (see also *chapter* and) are used, a good PE connection is ensured by the design of the housing. It is sufficient to connect the shield to the connector housing of the mating connector.



A "good" PE connection has only a low impedance even in the case of very high interference frequencies. Mounting the DUET_FL controller and the power supply unit to the same (metal) part of the machine is sufficient for most cases. If not, use a flexible copper strip (width approx. 10 mm) or a connecting cable with a Cu cross-section of at least 6 mm² to set up a PE connection.

**DANGER !**

For reasons of safety, all PE ground connectors must be connected prior to start-up. The regulations of EN 50178 concerning protective grounding must be complied with during installation!

INDEX:

A	
Actual speed value filter	54
Actual values.....	
Actual value window	116
Of servo	116
Alt+F4.....	118
Analog inputs	96
Analog monitor.....	
Numeric overflow limitation	98
Scaling	98
Analog monitor	98
Angle encoder.....	
Configuration	35
Angle encoder identification	35
B	
Baud rate.....	
Actual data transfer rate	102
Brake functions.....	95
C	
Cancel.....	114
CANopen.....	
Basic node number	100
Baud rate	100
Configuring the communication	100
Addition of DIN0...DIN3 to node address	101
Commissioning.....	
Loading a parameter set	33
Commissioning	33
Communication via communication objects .	117
Communication window for RS232 transmission	103
Configuring the communication	102
Control elements	115
Controller cascade	52
Controller enable logic	48
Course program.....	
Creating a program	79
Global settings	65
Course program	77
Current controller.....	
Manual configuration	41
Cycle times	121
D	
DC bus monitoring.....	42

Default parameter set	33
Destination parameters.....	
Positioning	66
Digital inputs.....	86
Configuration	88
Function overview	87
Digital outputs.....	91
Configuration	91
Function overview	91
Directories.....	117
Display units.....	
Display mode	45
E	
Emergency stop.....	
Decelerations	47
Error acknowledgement	112
Error analysis	112
Error elimination	112
Error management	113
Error messages.....	105
Error window	112
F	
Factory setting	102
G	
General configuration.....	44
H	
Hardware and software requirements	21
Homing.....	70
Speeds/Acceleration/Times	75
Status	70
Homing method.....	
Current position	74
Index pulse	72
Negative limit switch	71
Negative limit switch with index pulse evaluation	70
Negative stop	73
Negative stop with index pulse evaluation	72
Positive limit switch	72
Positive limit switch with index pulse evaluation	71
Positive stop	73
Positive stop with index pulse evaluation	73
Homing run.....	
Destination	75
Go to zero position after homing run.....	75
Offset start position	75
Settings	74

I	
Incremental encoder emulation	94
Input limits.....	46
Installation from CD-ROM	32
L	
Limit switch.....	
Decelerations	48
Loading a DCO-file.....	
Offline parameterization	155
Online parameterization	152
Loading a parameter set	152
Loading the firmware	156
M	
Manual input of angle encoder data	37
Messages.....	
Digital outputs	92
Following error	63
Remaining distance	67
Motor data.....	
Auto detect	39
Motor data	38
N	
Numerical input fields	114
O	
Offline parameterization.....	154
OK.....	114
Optimization.....	
Current controller	41
Position controller	64
Oscilloscope.....	
Channels	123
Settings	123
Time base	123
Trigger	123
Oscilloscope	123
P	
Position controller.....	
Manual configuration	63
Position-controlled mode	62
Positioning.....	
Destination parameters	66
Speeds/Acceleration/Times	67
Settings	66
Power stage.....	40
Q	

Quitting the program	118
R	
REF button	74
RS232 interface.....	102
S	
Safety parameters	47
Saving a DCO-file.....	
Offline parameterization	155
Online parameterization	152
Saving a parameter set	151
Scope of supply	22
Serial communication.....	
Troubleshooting.....	120
Optimization.....	102
Serial interface.....	
Firmware download	119
Offline parameterization	119
Retry with old parameters.....	119
Serial interface. Search baud rates	119
Setpoint ramp.....	59
Setpoint values	116
Setpoints	57
Speed controller.....	
Manual configuration	54
Speed limitation	48
Speed-controlled mode.....	54
T	
Temperature monitoring.....	43
Tool bar.....	
Fast access	122
Offline-online parameterisation	154
Torque constant	57
Torque-controlled mode.....	57
Transfer window	103
Homing run at controller enable.....	75
Setting of digital outputs	70

