



***DUET, DUET FLEXI, DUET AD and DUET HV***  
***DRIVE INTEGRATED SERVOMOTORS***

***MOTION CONTROL***

***MOTOR  
POWER***  
COMPANY



Motor Power Company  
[www.motorpowerco.com](http://www.motorpowerco.com)  
[info@motorpowerco.it](mailto:info@motorpowerco.it)

All rights reserved.  
Complete or partial reproduction  
is not allowed without our permission.

All technical data in this catalog  
may be changed without prior notice.

SEE IT BEFORE IT HAPPENS

**MOTOR  
POWER**  
COMPANY

## **CONTENTS**

Duet features and benefits	pag. 4
Product lineup	pag. 8
Duet type designation	pag. 9
Duet 40 ratings and specifications	pag. 13
Duet 40 dimensions	pag. 14
Duet 40 torque/speed charts	pag. 15
Duet 60 ratings and specifications	pag. 16
Duet 60 dimensions	pag. 17
Duet 60 torque/speed charts	pag. 18
Duet Flexi 60 ratings and specifications	pag. 20
Duet Flexi 60 dimensions	pag. 21
Duet Flexi 60 torque/speed charts	pag. 22
Duet Flexi 80 ratings and specifications	pag. 23
Duet Flexi 80 dimensions	pag. 24
Duet Flexi 80 torque/speed charts	pag. 25
Duet AD 80 ratings and specifications	pag. 26
Duet AD 80 dimensions	pag. 27
Duet AD 80 torque/speed charts	pag. 32
Duet HV 60 ratings and specifications	pag. 34
Duet HV 80 ratings and specifications	pag. 35
Duet HV 100 ratings and specifications	pag. 36
Duet HV 142 ratings and specifications	pag. 37
Duet HV dimensions	pag. 38
Duet HV torque/speed charts	pag. 40
Duet wiring connections	pag. 42
Duet Flexi wiring connections	pag. 43
Duet AD wiring connections	pag. 44
Duet HV wiring connections	pag. 48
Duet and Duet Flexi cable specifications	pag. 50
Duet AD cable specifications	pag. 51
Duet HV cable specifications	pag. 52
Feedback features	pag. 54
Brake features	pag. 56
Connectors specifications	pag. 57
Connectors and accessories	pag. 58

# **DUET, DUET AD AND DUET FLEXI**

**LOW VOLTAGE INTEGRATED BRUSHLESS DRIVE**

Cutting edge technology for decentralized architecture: **drive integrated servomotor DUET** series is the result of the wide-ranging experience that Motor Power Company has built over 30 years as marketing oriented player in the motion control market, gathering exceptional expertise in understanding and fulfilling customer needs. Everything you need for moving and controlling an axis is built directly into these highly compact single component: servomotor, feedback and intelligent servo drive featuring CANopen or Ethercat networking.

Either **Duet, Duet AD and Duet Flexi** include user friendly software tools enabling easy set up and tuning, ensure huge room saving in cabinet along with cables cutback between motor and drive and offer fast connectivity with plug in power connectors.



- > **ACCESSORIES FOR DUET, DUET AD AND DUET FLEXI**
- > **CABLES**
- > **CONNECTORS**

## **FEATURES AND BENEFITS**

- > **SYNCHRONOUS BRUSHLESS SERVOMOTOR, PERMANENTLY EXCITED**
- > **BUILT-IN DIGITAL DRIVE**
- > **RATED OUTPUT POWER FROM 60W TO 520W**
- > **SUPPLY VOLTAGE 48 VDC**
- > **MAXIMUM SERVOMOTOR SPEED UP TO 5000RPM**
- > **TORQUE, VELOCITY AND POSITION MODE**
- > **USER PROGRAMMABILITY**
- > **INSULATION CLASS F (155 °C)**
- > **IP 65 ON MOTOR BODY**
- > **RAL 9005 BLACK POWDER COATING**
- > **SHAFT BALANCING CLASS G 2,5 ACCORDING ISO 1940**
- > **BUILT-IN FEEDBACK 2 POLES RESOLVER, ABSOLUTE MULTITURN ENCODER (HIPERFACE), INCREMENTAL ENCODER, ABSOLUTE SINGLE TURN ENCODER**
- > **OPTIONAL ELECTROMAGNETIC PERMANENT-HOLDING BRAKE. ZERO BACKLASH**
- > **OPTIONAL SHAFT SEALING**

SEE IT BEFORE IT HAPPENS

**MOTOR  
POWER**  
COMPANY



**CANopen**

**EtherCAT**



# **DUET AND DUET FLEXI** LOW VOLTAGE INTEGRATED BRUSHLESS DRIVE

## **DUET**

The early range features unique performance potential thanks to extremely compact design and superior thermal dissipation characteristics, this allowing the units to be operated at full peak currents, with no need of power derating or extra ventilation. The execution is available either with network position or velocity mode functionalities.

- > **48 VDC CONTINUOUS SUPPLY VOLTAGE**
- > **24VDC LOGIC BACKUP**
- > **NOMINAL SPEED 3000RPM**
- > **IP 65 PROTECTION DEGREE (OPTIONAL OIL SEAL)**
- > **TORQUE, VELOCITY AND POSITION MODE**
- > **4096 CPR INCREMENTAL ENCODER**
- > **PERMANENT MAGNET SAFETY BRAKE OPTION**
- > **CANopen DS 301, DS402 CONNECTIVITY**
- > **CE, UL SERVO MOTOR**
- > **EASY AND INTUITIVE PC SOFTWARE ALLOWS A FAST PARAMETERIZATION**
- > **SIMPLE SCOPE**
- > **SCRIPT EDITING**
- > **USB PROGRAMMING KEY**

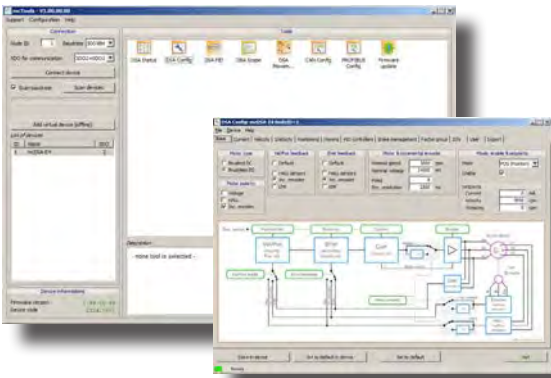

## **DUET FLEXI**

The Duet FLEXI line is the most up-to-date product range extension and responds to a rising demand of integrated products with advanced features. This range incorporates all the characteristics of the early DUET series and introduces options such as absolute encoder feedback and Ethercat or Profibus connectivity.

- > **48 VDC CONTINUOUS SUPPLY VOLTAGE**
- > **24VDC LOGIC BACKUP**
- > **NOMINAL SPEED 3000RPM**
- > **IP 65 PROTECTION DEGREE (OPTIONAL OIL SEAL)**
- > **FEEDBACK: MULTI TURN ABSOLUTE ENCODER, RESOLVER**
- > **TORQUE, VELOCITY AND POSITION MODE**
- > **PERMANENT MAGNET SAFETY BRAKE OPTION**
- > **CANopen DS301-DS402, OR EtherCAT™ CONNECTIVITY**
- > **CE, UL SERVO MOTOR**

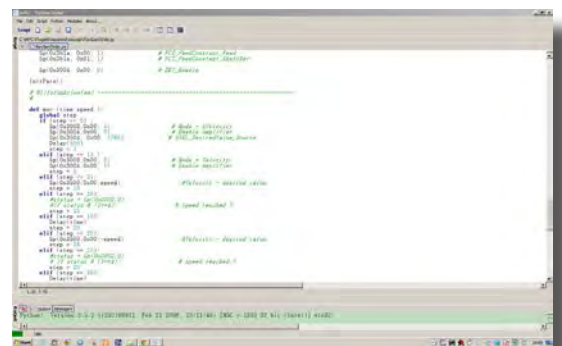

SEE IT BEFORE IT HAPPENS

**MOTOR  
POWER**  
COMPANY

# **DUET AD** LOW VOLTAGE INTEGRATED BRUSHLESS DRIVE

DUET AD models are the result of a design optimization conceived by Motor Power Company. A drive integrated servomotor with all features and benefits of Duet series, with more attention to business budget obtained with encoder embedding and an original integration design.

- > **48 VDC CONTINUOUS SUPPLY VOLTAGE**
- > **24VDC LOGIC BACKUP**
- > **NOMINAL SPEED 3900RPM**
- > **IP 65 PROTECTION DEGREE (OPTIONAL OIL SEAL)**
- > **TORQUE, VELOCITY AND POSITION MODE**
- > **14 BIT ABSOLUTE SINGLETURN ENCODER**
- > **PERMANENT MAGNET SAFETY BRAKE OPTION**
- > **CANopen DS 301, DS402 AND MODBUS RTU CONNECTIVITY**
- > **EtherCAT**
- > **PROFINET**
- > **GE, UL SERVO MOTOR**
- > **EASY AND INTUITIVE PC SOFTWARE**
- > **EXTERNAL BRAKING RESISTOR**
- > **4 CONFIGURABLE 24VDC INPUTS**
- > **2 CONFIGURABLE 24VDC OUTPUTS**
- > **1 ANALOG INPUT FOR SPEED CONTROL**

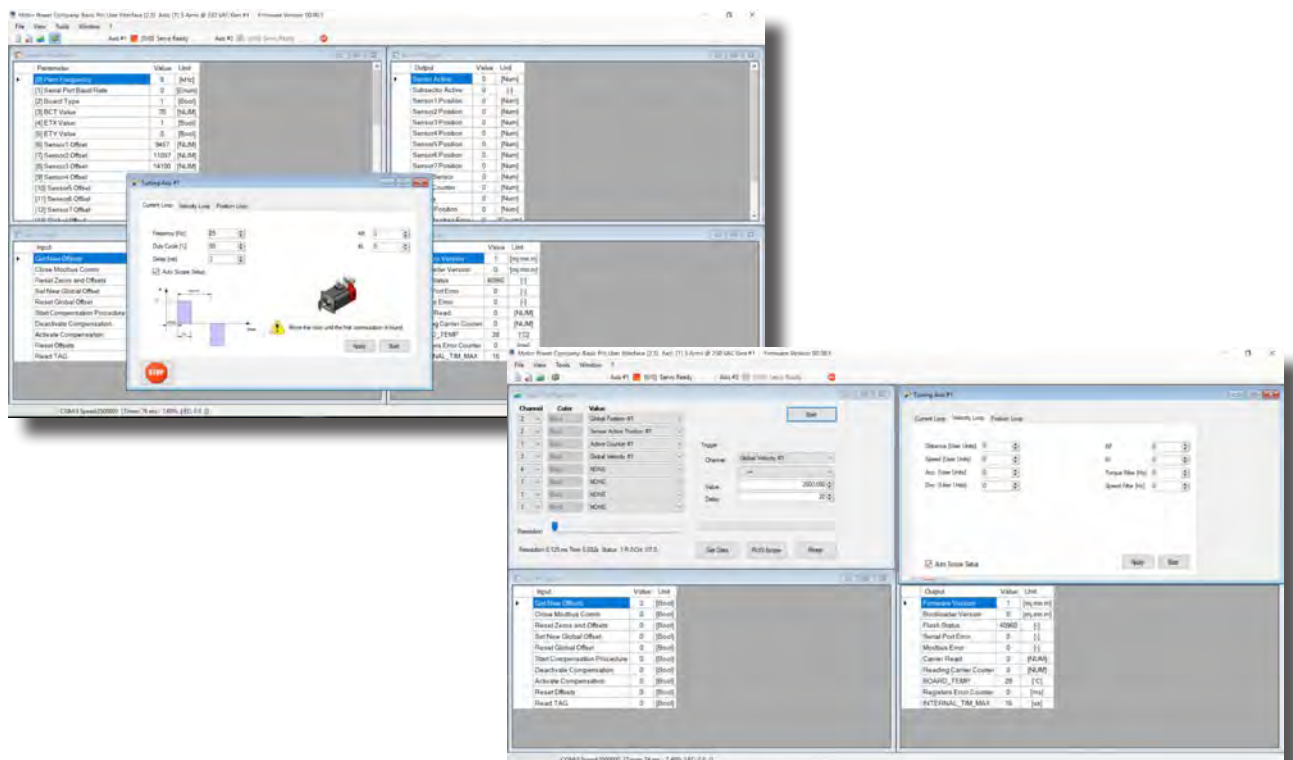

# **DUET HV** HIGH VOLTAGE INTEGRATED BRUSHLESS DRIVE

DUET HV is the new high voltage DUET series, a line consisting of brushless servomotor with integrated drive - featuring models from 1,3 to 14Nm - incorporating as well absolute encoder for uncompromised precision in positioning.

This device can either work via Ethercat connectivity through the control of a master controller or as a stand alone unit wherever synchronized motion between axes is not mandatory for application operation. When used in this configuration, DUET HV can manage machine cycle with its internal PLC. Full programmability allows to perform application in a very efficient way and permits the creation of sophisticated architectures with complex trajectories, allowing decentralized motion distribution and high optimization in cabling and cabinet design.



## **DUET HV FEATURES AND BENEFITS**

- > Synchronous brushless servomotor permanently excited
- > Nominal power supply 560Vdc
- > Stall torque 1,3 - 2,8 - 4 - 5,6 - 8 - 14 Nm
- > Nominal speed 3000 rpm
- > Absolute multi and singleturn encoder
- > STO SIL 3 (safe torque off)
- > IP65 protection
- > Internal optional brake
- > Integrated movement features: device profile DS402, interpolated mode, positioning, extended gearing function, homing, capture
- > Stand alone programmability according to the standard IEC61131, ST language
- > Capture input
- > PC parametrization tool
- > I2t, Overload, Short circuit, Overtemperature, Overvoltage Protection
- > Optional cables, power supply
- > On board I/Os:
  - 4 digital IN 24Vdc general purpose, configurable as PSTOP, NSTOP, Enable, Home, Capture, Step/Direction
  - 3 digital OUT 24Vdc 250mA, general purpose
  - 2 digital IN 24Vdc or 1 RTO OUT
  - 1 digital IN/OUT 24Vdc with configurable function
  - 3 differential I/O's configurable as master incremental encoder or absolute encoder input
  - Encoder emulation output
  - PWM IN or OUT
  - Auxiliary rs485
  - I/O extension port
  - 1 Analogue IN  $\pm 10V$



SEE IT BEFORE IT HAPPENS

**MOTOR  
POWER**  
COMPANY

# PRODUCT LINEUP

Type	Rated Output Power [W]	Rated Torque [Nm]	Peak Torque [Nm]	Rated Voltage [Vdc]	Rated Speed [rpm]	Feedback	Fieldbus
DUET 40 0,16 00	60	0,19	0,48	48	3000	4096 cpr incremental encoder	CanOpen
DUET 40 0,32 01	100	0,32	0,96	48	3000	4096 cpr incremental encoder	CanOpen
DUET 60 0,65 01	190	0,60	1,95	48	3000	4096 cpr incremental encoder	CanOpen
DUET 60 1,3 02	370	1,17	2,4	48	3000	4096 cpr incremental encoder	CanOpen
DUET FLEXI 60 0,65 01	200	0,64	1,95	48	3000	<ul style="list-style-type: none"> <li>• resolver</li> <li>• absolute multiturn encoder</li> </ul>	<ul style="list-style-type: none"> <li>• CanOpen</li> <li>• Ethercat</li> </ul>
DUET FLEXI 60 1,3 01	310	1,18	3,75	48	2500	<ul style="list-style-type: none"> <li>• resolver</li> <li>• absolute multiturn encoder</li> </ul>	<ul style="list-style-type: none"> <li>• CanOpen</li> <li>• Ethercat</li> </ul>
DUET FLEXI 80 1,5 03	390	1,5	4,5	48	2500	<ul style="list-style-type: none"> <li>• resolver</li> <li>• absolute multiturn encoder</li> </ul>	<ul style="list-style-type: none"> <li>• CanOpen</li> <li>• Ethercat</li> </ul>
DUET FLEXI 80 2 03	520	2	5,6	48	2500	<ul style="list-style-type: none"> <li>• resolver</li> <li>• absolute multiturn encoder</li> </ul>	<ul style="list-style-type: none"> <li>• CanOpen</li> <li>• Ethercat</li> </ul>
DUET AD 1,5 03	480	1,53	4,5	48	3000	Singleturn absolute encoder 14 bit	<ul style="list-style-type: none"> <li>• CanOpen</li> <li>• Modbus RTUY 485</li> <li>• Ethercat</li> <li>• Profinet</li> </ul>
DUET AD 2,8 02	630	2	5,36	48	3000	Singleturn absolute encoder 14 bit	<ul style="list-style-type: none"> <li>• CanOpen</li> <li>• Modbus RTUY 485</li> <li>• Ethercat</li> <li>• Profinet</li> </ul>
DUET HV 60 1,3 15	370	1,18	3,9	560	3000	Multi and singleturn absolute encoder	Ethercat
DUET HV 80 2,8	800	2,55	8,4	560	3000	Multi and singleturn absolute encoder	Ethercat
DUET HV 80 4	1068	3,4	12	560	3000	Multi and singleturn absolute encoder	Ethercat
DUET HV 100 5,6	1320	4,2	22	560	3000	Multi and singleturn absolute encoder	Ethercat
DUET HV 100 8	1570	5	22	560	3000	Multi and singleturn absolute encoder	Ethercat
DUET HV 142 16,5 17	3500	11,1	42	560	3000	Multi and singleturn absolute encoder	Ethercat

SEE IT BEFORE IT HAPPENS



**DUET TYPE**

DUET 40 0,16 E1 1 C 1 XXX

DUET

Model

Feedback

Brake

Fieldbus

Mechanical arrangement

Optional

1

2

3

4

5

6

1

Model

40 0,16  
40 0,32  
60 0,65  
60 1,3

2

Feedback

E1 = 4096 cpr incremental encoder

3

Brake

0 = without brake  
1 = with brake

4

Fieldbus

C = CanOpen

5

Mechanical Arrangement

0 - Shaft with key / without oil seal (front flange side IP 54)  
1 - Shaft with key / with oil seal (front flange side IP 65)  
2 - Shaft without key / without oil seal (front flange side IP 54)  
3 - Shaft without key / with oil seal (front flange side IP 65)

N.B.: All motor body are IP 65

**DUET FLEXI TYPE**

DUET FL 60 0,65 R1 0 C 1 1

DUET FLEXI

Model

Feedback

Brake

Fieldbus

Mechanical arrangement

Optional

1

2

3

4

5

6

1

Model

60 0,65  
60 1,3  
80 1,5  
80 2,0

2

Feedback

R1 = Resolver 2p  
A1 = Absolute multiturn encoder

3

Brake

0 = without brake  
1 = with brake

4

Fieldbus

C = CanOpen  
E = Ethercat

5

Mechanical Arrangement

0 - Shaft with key / without oil seal (front flange side IP 54)  
1 - Shaft with key / with oil seal (front flange side IP 65)  
2 - Shaft without key / without oil seal (front flange side IP 54)  
3 - Shaft without key / with oil seal (front flange side IP 65)

N.B.: All motor body are IP 65



<b>1</b>	Model	80 1,5 80 2,8
<b>2</b>	Winding	Already specified in motor model
<b>3</b>	Feedback	E6 = 14 Bit absolute singleturn encoder
<b>4</b>	Brake	0 = without brake 1 = with brake
<b>5</b>	Fielbus	C = Can Open D = Modbus RTU E = Ethercat P = Profinet
<b>6</b>	Mechanical Arrangement	0 - Shaft with key / without oil seal (front flange side IP 54) 1 - Shaft with key / with oil seal (front flange side IP 65) 2 - Shaft without key / without oil seal (front flange side IP 54) 3 - Shaft without key / with oil seal (front flange side IP 65)

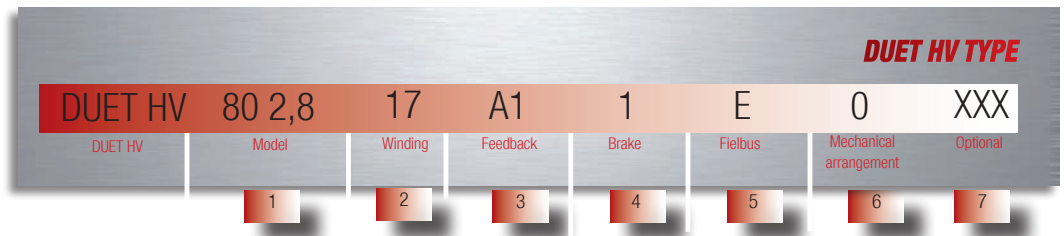

1	Model	60 1,3 = Flange 60 mm - 1,3 Nm (8 poles) 80 2,8 = Flange 80 mm - 2,96 Nm (8 poles) 80 4 = Flange 80 mm - 4 Nm (8 poles) 100 5,6 = Flange 100 mm - 5,6 Nm (8 poles) 100 8 = Flange 100 mm - 8 Nm (8 poles) 142 16,5 = Flange 142 mm - 14 Nm (6 poles)
2	Winding	Already specified in motor model
3	Feedback	A1 = Absolute Multiturn Encoder 12+12 Bits 128 Sin/Cos revolution A3 = Absolute Multiturn Encoder 9+12 Bits 16 Sin/Cos revolution A5 = Absolute Singleturn Encoder 9 Bits 16 Sin/Cos revolution
4	Brake	0 = without brake 1 = with brake
5	Fielbus	E = Ethercat
6	Mechanical Arrangement	0 - Shaft with key / without oil seal (front flange side IP 54) 1 - Shaft with key / with oil seal (front flange side IP 65) 2 - Shaft without key / without oil seal (front flange side IP 54) 3 - Shaft without key / with oil seal (front flange side IP 65)

# ***DUET***

***LOW VOLTAGE INTEGRATED BRUSHLESS DRIVE***



## DUET 40 RATINGS AND SPECIFICATIONS

INSULATION CLASS	F	AMBIENT TEMPERATURE	0 to 40 °C
ENCLOSURE	Totally enclosed. Self-cooled	AMBIENT HUMIDITY	5 to 85% (non-condensing)
PROTECTION CLASS	IP 65 standard on the body	POLES	8
MOTOR INSULATION SYSTEM UL /CSA	cURus , DV155J File nr. : E216686	CE certified	

### DUET 40 0,16 00

### DUET 40 0,32 01

Rated Voltage	Vdc	48	48
Auxiliary Voltage (+6% -10%)	Vdc	24	24
Minimum Voltage	Vdc	9	9
Maximum Voltage	Vdc	60	60
Stall Torque	Nm	0,21	0,34
Peak Torque	Nm	0,48	0,96
Rated Torque	Nm	0,19	0,32
Rated Output Power	W	60	100
Stall Current	Arms	2,84	3,6
Peak Current	Arms	6,5	10,2
Rated Current	Arms	2,6	3,5
Rated Speed @48Vdc	rpm	3000	3000
Maximum Speed @48Vdc	rpm	5000	5000
Maximum Speed @24Vdc	rpm	3200	2600
Torque Constant (± 5%)	Nm/Arms	0,074	0,094
Voltage Constant (± 5%)	Vrms/Krpm	4,5	5,7
Phase/phase resistance (± 10%@25°C)	Ohm	1,77	1
Phase/phase inductance (± 10%)	mH	1,6	1,42
Electrical time constant	ms	0,9	1,4
Thermal Resistance	°C/W	2,38	2,3
Mechanical time constant	ms	1,3	0,8
Rotor Inertia (*)	Kg cm <sup>2</sup>	0,027	0,047
Duet weight	Kg	0,55	0,7
Duet weight with brake	Kg	0,7	0,85
Axial Load	N	30 (applied on the shaft's center)	
Radial Load	N	180 (applied on the shaft's center)	

Rated output with 250 x 250 x 6 mm metallic heat sink flange coupling - Derating must be considered if the oil seal is applied - IP 54 standard shaft bushing  
(\*) without brake and without feedback

# DUET 40 DIMENSIONS

## DUET 40 0,16 00

## DUET 40 0,32 01

L (Without Brake)	mm	131	149
L (With Brake)	mm	162	180
A	mm	25	25
d	mm	8 (h6)	8 (h6)
ch	mm	3x3x15	3x3x15
M	mm	30 (h7)	30 (h7)
E	mm	2,5	2,5
N	mm	46	46
P	mm	4,2	4,2

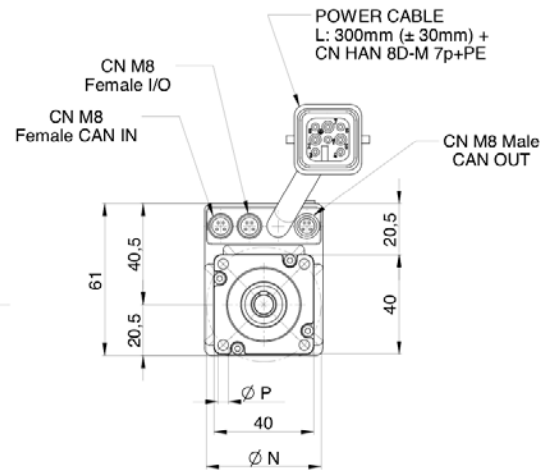
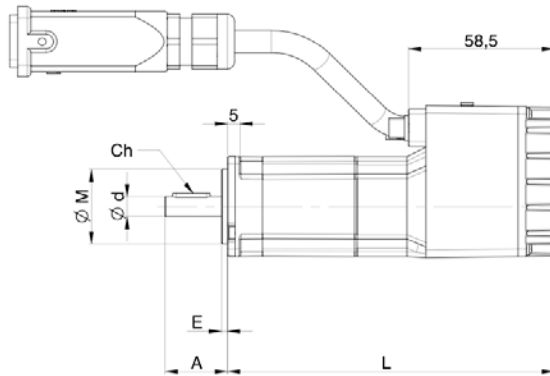
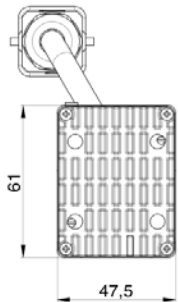

Dimensions in mm

SEE IT BEFORE IT HAPPENS

**MOTOR  
POWER**  
COMPANY

# DUET 40 TORQUE / SPEED CHARTS

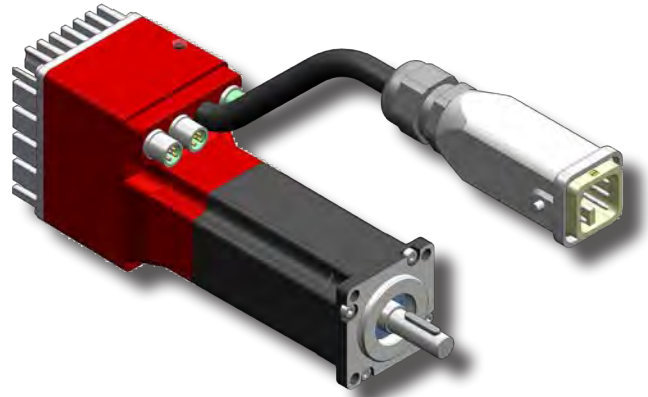

**DUET 40 0,16 00**

**DUET 40 0,32 01**

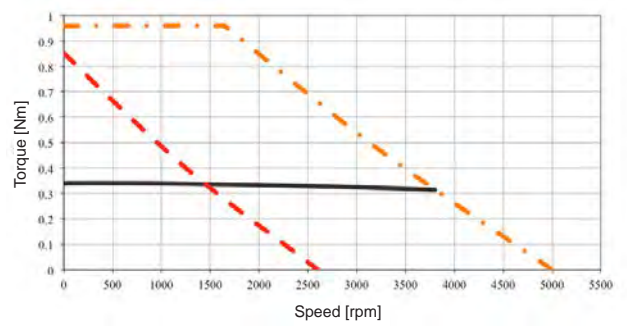
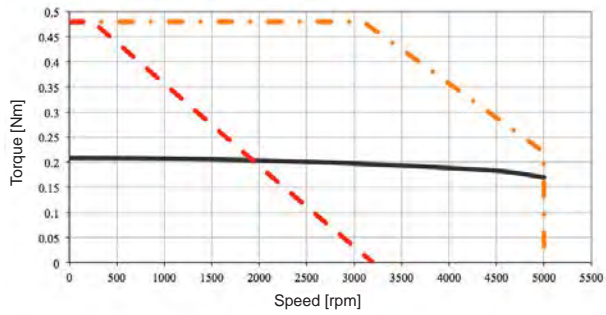

## DUET 60 RATINGS AND SPECIFICATIONS

INSULATION CLASS	F	AMBIENT TEMPERATURE	0 to 40 °C
ENCLOSURE	Totally enclosed. Self-cooled	AMBIENT HUMIDITY	5 to 85% (non-condensing)
PROTECTION CLASS	IP 65 standard on the body	POLES	8
MOTOR INSULATION SYSTEM UL /CSA	cURus , DV155J File nr. : E216686	CE certified	

### DUET 60 0,65 01

### DUET 60 1,3 02

Rated Voltage	Vdc	48	48
Auxiliary Voltage (+6% -10%)	Vdc	24	24
Minimum Voltage	Vdc	9	9
Maximum Voltage	Vdc	60	60
Stall Torque	Nm	0,57	0,68 1,31*
Peak Torque	Nm	1,95	2,4
Rated Torque	Nm	0,60	0,66 1,17*
Rated Output Power	W	190	210 370*
Stall Current	Arms	6,0	6,1 11,7*
Peak Current	Arms	20,7	21,2
Rated Current	Arms	6,5	6,1 10,4*
Rated Speed @48Vdc	rpm	3000	3000
Maximum Speed @48Vdc	rpm	5000	4500
Maximum Speed @24Vdc	rpm	2600	2200
Torque Constant (± 5%)	Nm/Arms	0,094	0,112
Voltage Constant (± 5%)	Vrms/Krpm	5,7	6,8
Phase/phase resistance (± 10%@25°C)	Ohm	0,38	0,2
Phase/phase inductance (± 10%)	mH	0,9	0,68
Electrical time constant	ms	2,4	3,4
Thermal Resistance	°C/W	1,9	1,4
Mechanical time constant	ms	0,83	0,57
Rotor Inertia <sup>(a)</sup>	Kg cm <sup>2</sup>	0,13	0,24
Duet weight	Kg	1,2	1,6
Duet weight with brake	Kg	1,6	2
Axial Load	N	70 (applied on the shaft's center)	
Radial Load	N	220 (applied on the shaft's center)	

Rated output with 250 x 250 x 6 mm metallic heat sink flange coupling - Derating must be considered if the oil seal is applied - IP 54 standard shaft bushing - Stall torque at switching frequency 12,5Khz

\* Intermittent duty S2 10"/40"

(\*) without brake and without feedback



# DUET 60 DIMENSIONS

**DUET 60 0,65 01**

**DUET 60 1,3 02**

L (Without Brake)	mm	153	178
L (With Brake)	mm	190	215
A	mm	23	30
d	mm	11 (h6)	14 (h6)
ch	mm	4x4x18	5x5x25
M	mm	50 (h7)	50 (h7)
E	mm	3	3
N	mm	70	70
P	mm	5,2	5,2

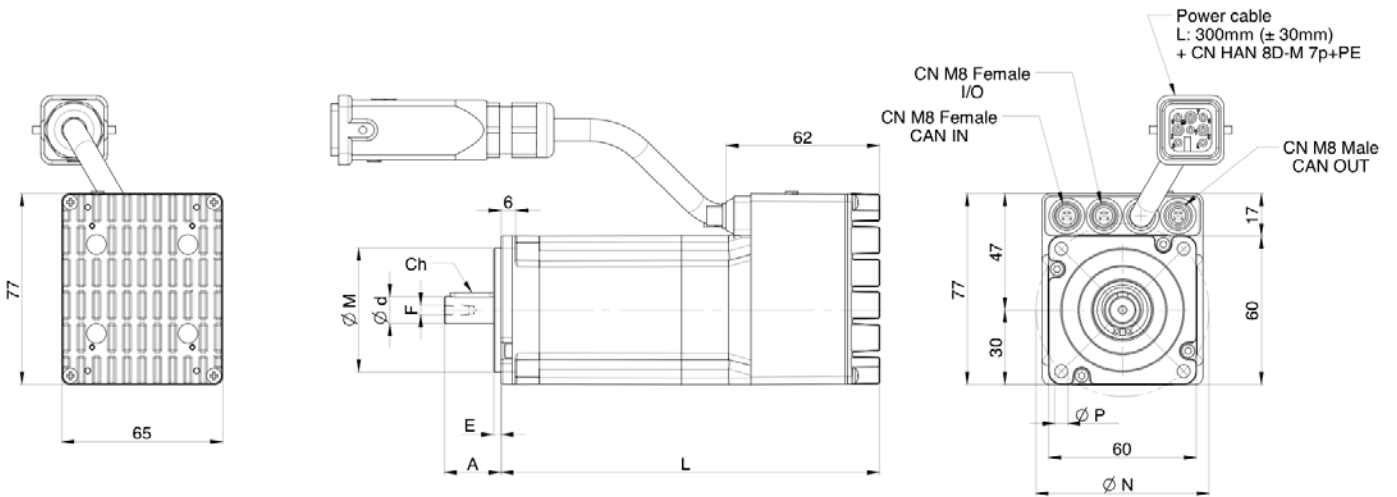

Dimensions in mm

SEE IT BEFORE IT HAPPENS

**MOTOR  
POWER**  
COMPANY

# DUET 60 TORQUE /SPEED CHARTS

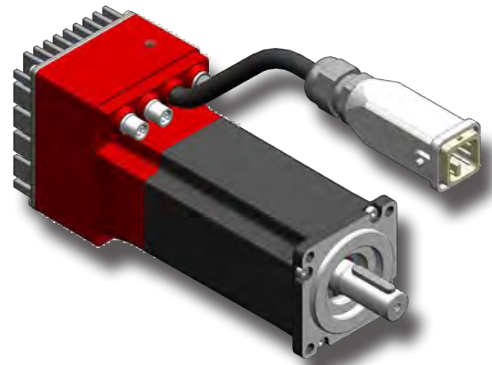

**DUET 60 0,65 01**

**DUET 60 1,3 02**

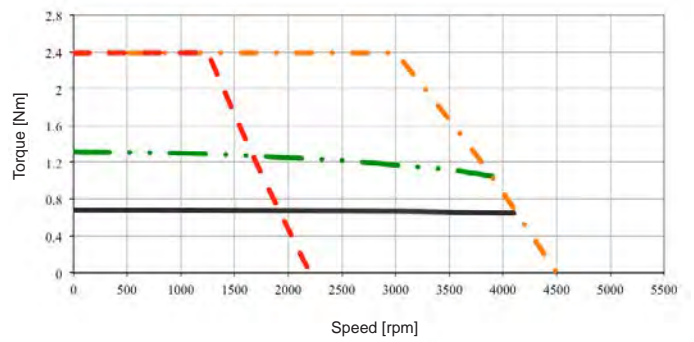
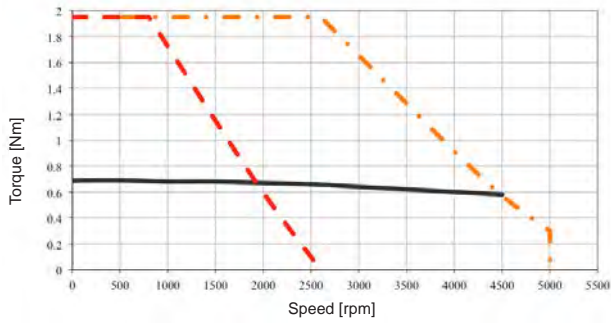

SEE IT BEFORE IT HAPPENS



# ***DUET FLEXI***

***LOW VOLTAGE INTEGRATED BRUSHLESS DRIVE***



## DUET FLEXI 60 RATINGS AND SPECIFICATIONS

INSULATION CLASS	F	AMBIENT TEMPERATURE	0 to 40 °C
ENCLOSURE	Totally enclosed. Self-cooled	AMBIENT HUMIDITY	5 to 85% (non-condensing)
PROTECTION CLASS	IP 65 standard on the body	POLES	8
MOTOR INSULATION SYSTEM UL /CSA	cURus , DV155J File nr. : E216686	CE certified	

### DUET FLEXI 60 0,65 01

### DUET FLEXI 60 1,3 01

Rated Voltage	Vdc	48	48
Auxiliary Voltage (+6% -10%)	Vdc	24	24
Minimum Voltage	Vdc	24	24
Maximum Voltage	Vdc	60	60
Stall Torque	Nm	0,65	1,3**
Peak Torque	Nm	1,95	3,75
Rated Torque	Nm	0,64	1,18**
Rated Output Power	W	200	310**
Rated Output Power @ 10 Arms	W	-	240
Stall Current	Arms	6,9	13,9**
Peak Current	Arms	20,7	39,8
Rated Current	Arms	7	12,9**
Rated Speed @48Vdc	rpm	3000	2500
Maximum Speed @48Vdc	rpm	5000	5000
Maximum Speed @24Vdc	rpm	2600	2600
Torque Constant (± 5%)	Nm/Arms	0,094	0,094
Voltage Constant (± 5%)	Vrms/Krpm	5,7	5,7
Phase/phase resistance (± 10%@25°C)	Ohm	0,38	0,16
Phase/phase inductance (± 10%)	mH	0,90	0,48
Electrical time constant	ms	2,4	3
Thermal Resistance	°C/W	1,9	1,4
Mechanical time constant	ms	0,83	0,65
Rotor Inertia <sup>(a)</sup>	Kg cm <sup>2</sup>	0,13	0,24
Duet weight	Kg	1,4	1,8
Duet weight with brake	Kg	1,8	2,2
Axial Load	N	70 (applied on the shaft's center)	
Radial Load	N	220 (applied on the shaft's center)	

Rated output with 250 x 250 x 6 mm metallic heat sink flange coupling - Derating must be considered if the oil seal is applied - IP 54 standard shaft bushing - Continuous duty (S1) operation with cooling system appropriately sized.

\*\* @power stage temperature ≤ 50°C (rated current limited to 10 Arms @ power stage temperature > 50°C < 70°C)

(†) without brake and without feedback

# DUET FLEXI 60 DIMENSIONS

## DUET FLEXI 60 0,65 01

## DUET FLEXI 60 1,3 01

L (Without Brake)	mm	166	191
L (With Brake)	mm	203	228
A	mm	23	30
d	mm	11 (h6)	14 (h6)
ch	mm	4x4x18	5x5x25
F	mm	M4	M5
PF	mm	10	12,5
E	mm	12,5	16

### CanOpen Connection

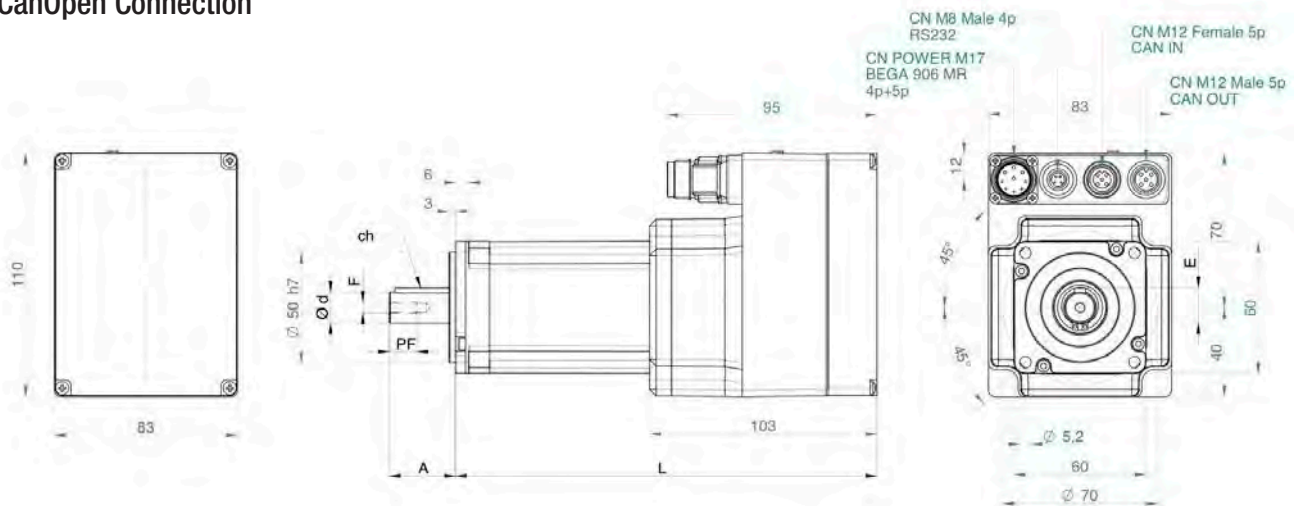

### Ethercat Connection

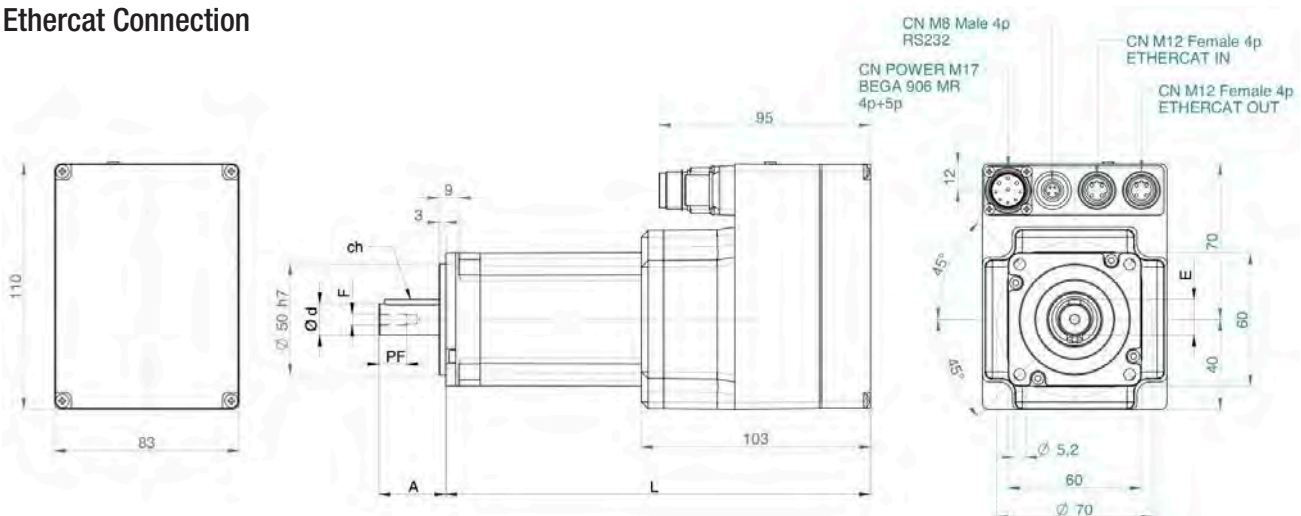

Dimensions in mm

BEFORE IT HAPPENS

**MOTOR  
POWER**  
COMPANY

# DUET FLEXI 60 TORQUE /SPEED CHARTS

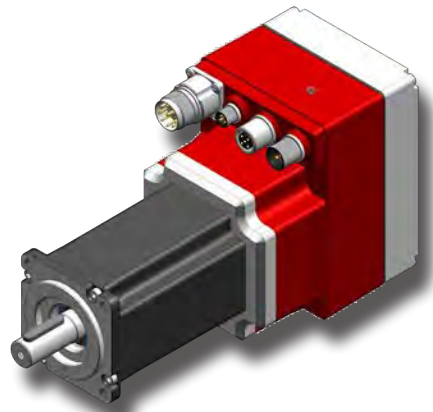

## DUET FLEXI 60 0,65 01

## DUET FLEXI 60 1,3 01

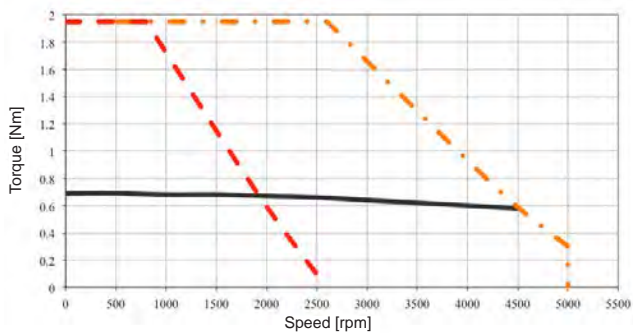

Continuous duty (S1) operation with cooling system appropriately sized.

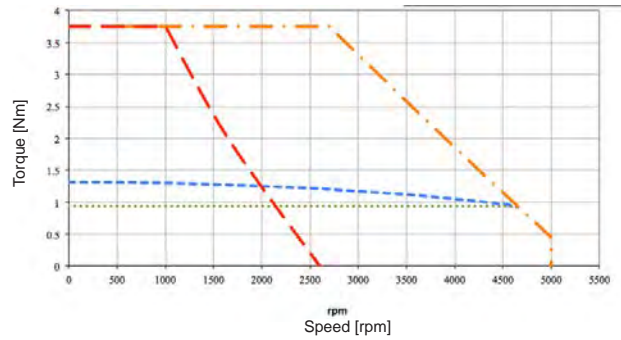

Continuous duty (S1) operation with cooling system appropriately sized.

SEE IT BEFORE IT HAPPENS

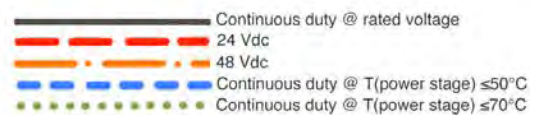

## DUET FLEXI 80 RATINGS AND SPECIFICATIONS

TIME RATING	Continuous	AMBIENT TEMPERATURE	0 to 40 °C
INSULATION CLASS	F	AMBIENT HUMIDITY	5 to 85% (non-condensing)
ENCLOSURE	Totally enclosed. Self-cooled	POLES	8
PROTECTION CLASS	IP 65 standard on the body	CE certified	
MOTOR INSULATION SYSTEM UL /CSA	cURus , DV155J File nr.:E216686		

### DUET FLEXI 80 1,5 03

### DUET FLEXI 80 2 03

Rated Voltage	Vdc	48	48
Auxiliary Voltage (+6% -10%)	Vdc	24	24
Minimum Voltage	Vdc	24	24
Maximum Voltage	Vdc	60	60
Stall Torque	Nm	1,5**	2**
Peak Torque	Nm	4,5	5,6
Rated Torque	Nm	1,5**	2**
Rated Output Power	W	390**	520**
Rated Output Power @ 10 Arms	W	360	360
Stall Current	Arms	10,7**	14,2**
Peak Current	Arms	32	39,8
Rated Current	Arms	11**	14,7**
Rated Speed @48Vdc	rpm	2500	2500
Maximum Speed @48Vdc	rpm	3600	3600
Maximum Speed @24Vdc	rpm	1800	1800
Torque Constant (± 5%)	Nm/Arms	0,141	0,141
Voltage Constant (± 5%)	Vrms/Krpm	8,5	8,5
Phase/phase resistance (± 10%@25°C)	Ohm	0,14	0,12
Phase/phase inductance (± 10%)	mH	0,53	0,31
Electrical time constant	ms	3,9	2,6
Thermal Resistance	°C/W	1,7	1,3
Mechanical time constant	ms	0,66	1,06
Rotor Inertia (°)	Kg cm <sup>2</sup>	0,64	1,16
Duet weight	Kg	2,4	3,2
Duet weight with brake	Kg	3,1	3,9
Axial Load	N	110 (applied on the shaft's center)	
Radial Load	N	350 (applied on the shaft's center)	

Rated output with 250 x 250 x 6 mm metallic heat sink flange coupling - Derating must be considered if the oil seal is applied - IP 54 standard shaft bushing - Continuous duty (S1) operation with cooling system appropriately sized.  
 \*\* @power stage temperature ≤ 50°C (rated current limited to 10 Arms @ power stage temperature > 50°C < 70°C).  
 (\*) without brake and without feedback

# DUET FLEXI 80 DIMENSIONS

		<b>DUET FLEXI 80 1,5 03</b>	<b>DUET FLEXI 80 2 03</b>
--	--	-----------------------------	---------------------------

L (Without Brake)	mm	183	208
L (With Brake)	mm	225 [228 with A1 feedback]	250 [253 with A1 feedback]
A	mm	30	40
d	mm	14 (h6)	19 (h6)
ch	mm	5x5x25	6x6x30
F	mm	M5	M6
PF	mm	12,5	16
E	mm	16	21,5

## CanOpen Connection

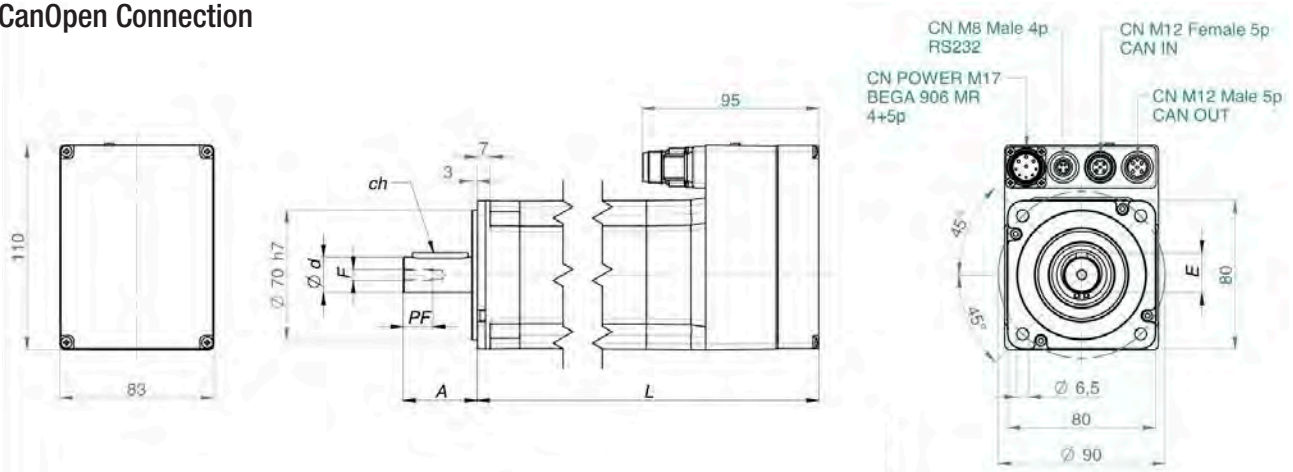

## Ethercat Connection

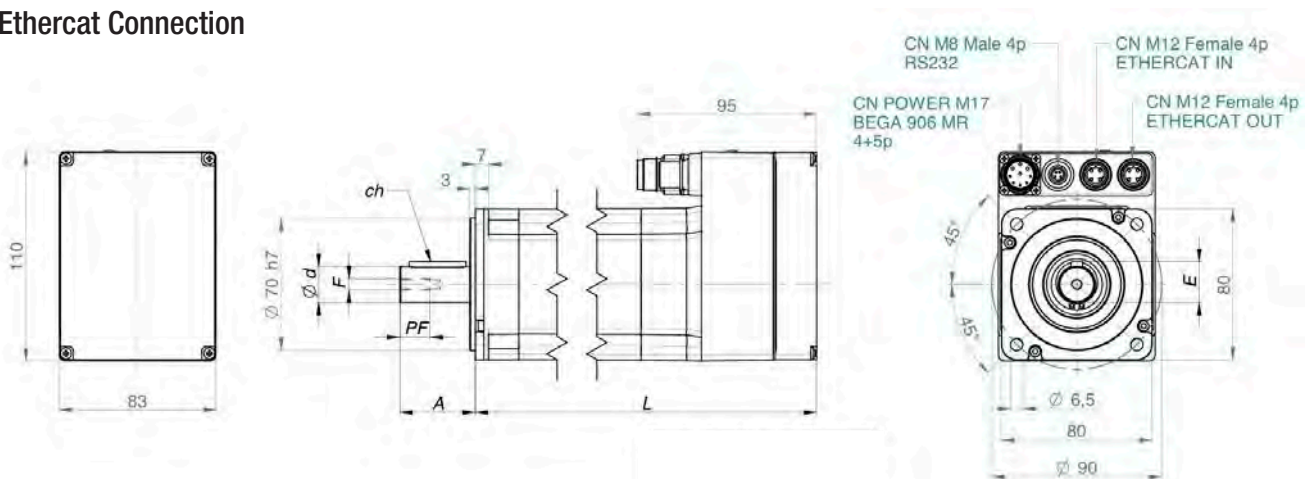

Dimensions in mm

SEE IT BEFORE IT HAPPENS



# DUET FLEXI 80 TORQUE /SPEED CHARTS

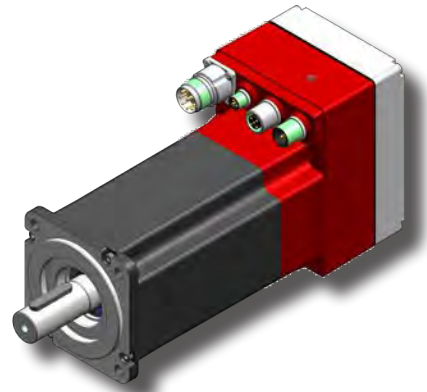

## DUET FLEXI 80 1,5 03

## DUET FLEXI 80 2 03

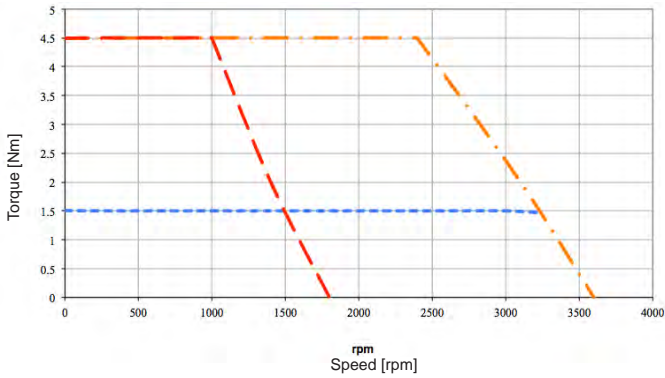

Continuous duty (S1) operation with cooling system appropriately sized.

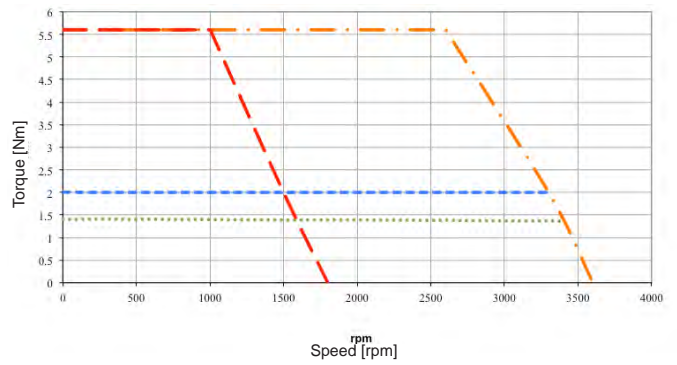

Continuous duty (S1) operation with cooling system appropriately sized.

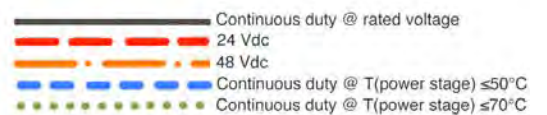

# ***DUET AD***

***LOW VOLTAGE INTEGRATED BRUSHLESS DRIVE***



## DUET AD 80 RATINGS AND SPECIFICATIONS

TIME RATING	Continuous	AMBIENT TEMPERATURE	0 to 40 °C
INSULATION CLASS	F	AMBIENT HUMIDITY	5 to 85% (non-condensing)
ENCLOSURE	Totally enclosed. Self-cooled	POLES	8
PROTECTION CLASS	IP 65 standard on the body	CE certified	
MOTOR INSULATION SYSTEM UL /CSA	cURus , DV155J File nr.:E216686		

### DUET AD 80 1,5 03

### DUET AD 80 2,8 02

Rated Voltage	Vdc	48	48
Auxiliary Voltage (+6% -10%)	Vdc	24	24
Minimum Voltage	Vdc	40	40
Maximum Voltage	Vdc	48	48
Stall Torque	Nm	1,74	2,22
Peak Torque	Nm	4,5	5,36
Rated Torque	Nm	1,53	2
Rated Output Power	W	480	630
Stall Current	Arms	12,3	19,65
Peak Current	Arms	35,1	50
Rated Current	Arms	11	17,7
Rated Speed @48Vdc	rpm	3000	3000
Maximum Speed @48Vdc	rpm	3600	4500
Torque Constant (± 5%)	Nm/Arms	0,141	0,113
Voltage Constant (± 5%)	Vrms/Krpm	8,5	6,8
Phase/phase resistance (± 10%@25°C)	Ohm	0,136	0,064
Phase/phase inductance (± 10%)	mH	0,53	0,24
Electrical time constant	ms	3,9	3,75
Thermal Resistance	°C/W	1,67	1,4
Mechanical time constant	ms	0,8	0,65
Rotor Inertia (*)	Kg cm <sup>2</sup>	0,64	1,16
Duet weight	Kg	2,6	3,3
Duet weight with brake	Kg	3,3	4
Axial Load	N	110 (applied on the shaft's center)	
Radial Load	N	350 (applied on the shaft's center)	

Rated output with 250 x 250 x 6 mm metallic heat sink flange coupling - Derating must be considered if the oil seal is applied - IP 54 standard shaft bushing - Continuous duty (S1) operation with cooling system appropriately sized.  
(\*) without brake and without feedback

# DUET AD 80 DIMENSIONS (MODBUS MODEL)

		<b>DUET AD 80 1,5</b>	<b>DUET AD 80 2,8</b>
L (Without Brake)	mm	166	191
L (With Brake)	mm	208	233
A	mm	30	40
d	mm	14 (h6)	19 (h6)
ch	mm	5x5x25	6x6x30
F	mm	M5	M6
PF	mm	12,5	16
E	mm	16	21,5

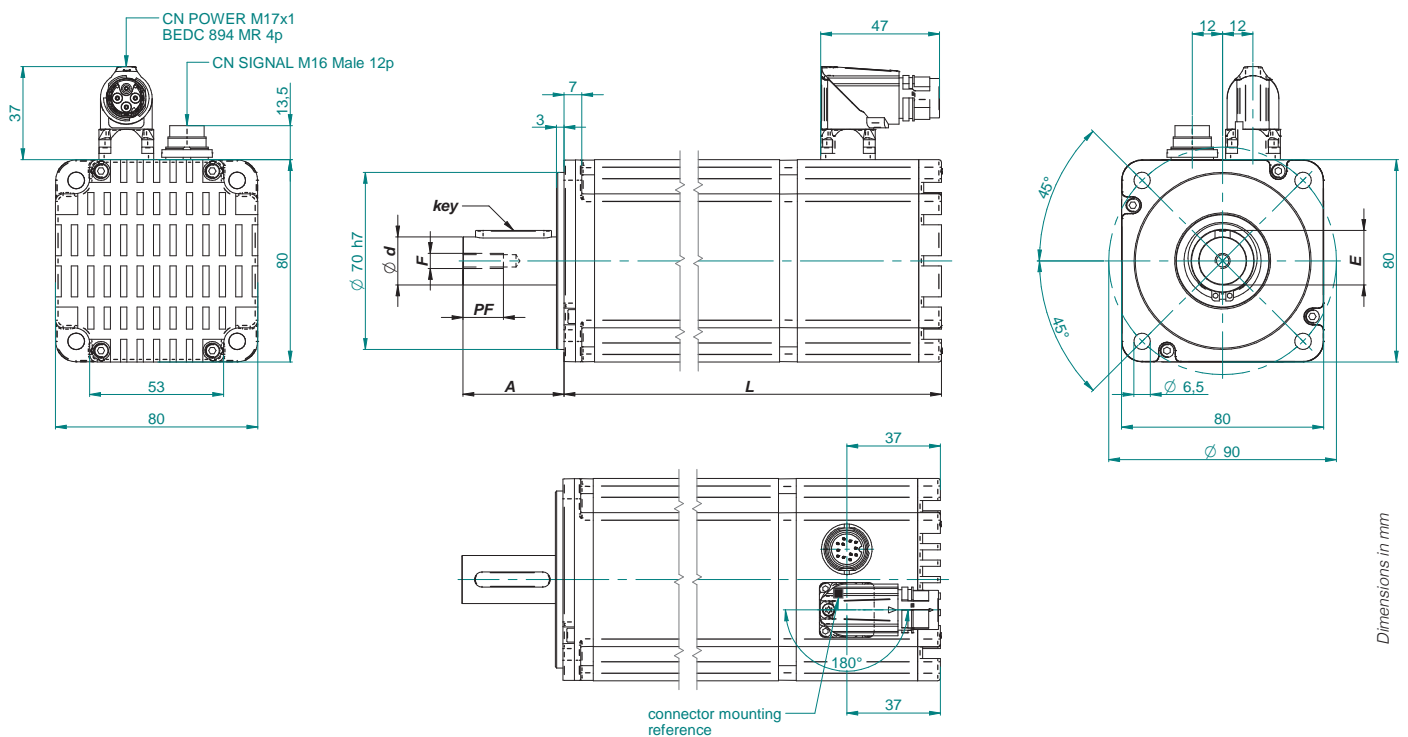

Dimensions in mm

SEE IT BEFORE IT HAPPENS

## DUET AD 80 DIMENSIONS (CANOPEN MODEL)

		DUET AD 80 1,5	DUET AD 80 2,8
L (Without Brake)	mm	185	210
L (With Brake)	mm	227	252
A	mm	30	40
d	mm	14 (h6)	19 (h6)
ch	mm	5x5x25	6x6x30
F	mm	M5	M6
PF	mm	12,5	16
E	mm	16	21,5

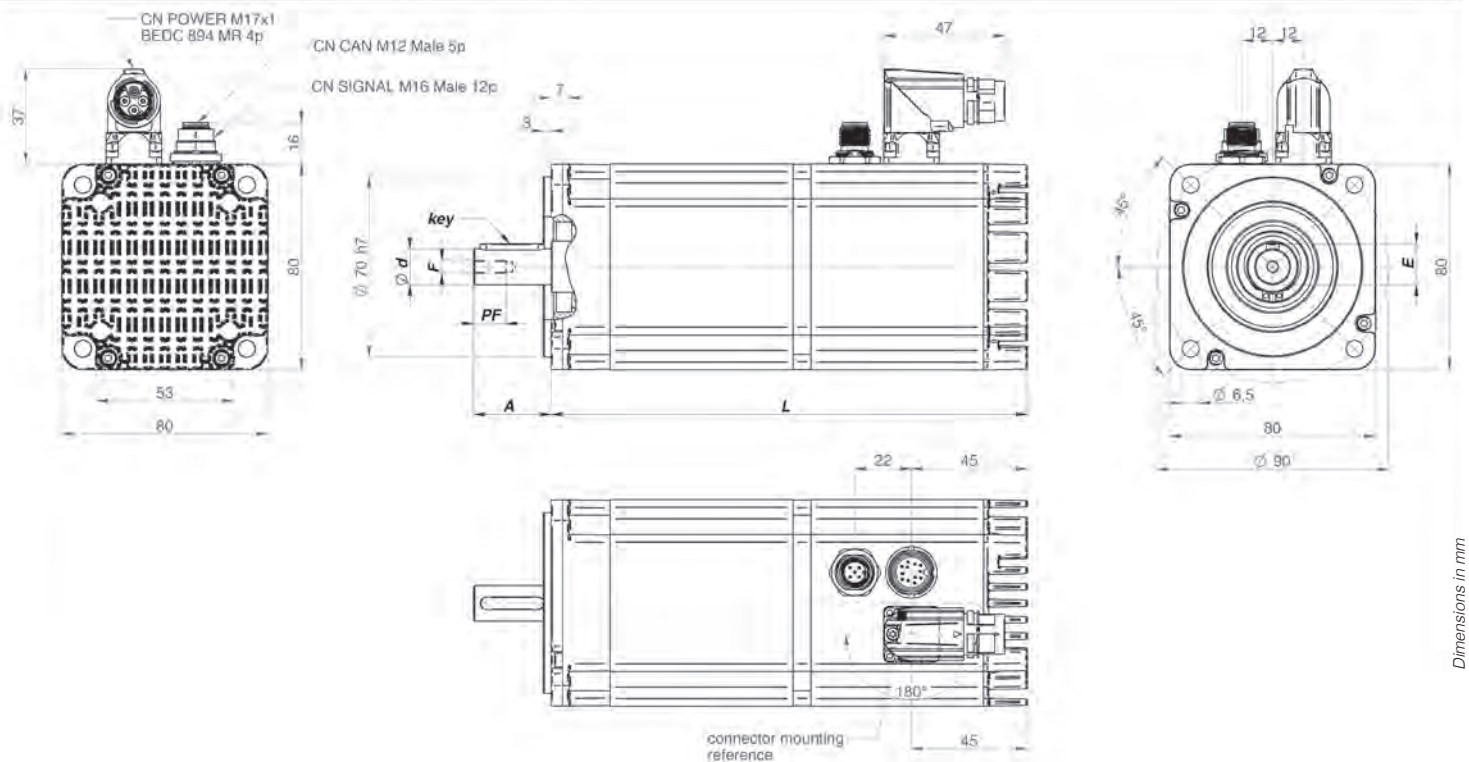

## DUET AD 80 DIMENSIONS (ETHERCAT MODEL)

		DUET AD 80 1,5	DUET AD 80 2,8
L (Without Brake)	mm	185	210
L (With Brake)	mm	227	252
A	mm	30	40
d	mm	14 (h6)	19 (h6)
ch	mm	5x5x25	6x6x30
F	mm	M5	M6
PF	mm	12,5	16
E	mm	16	21,5

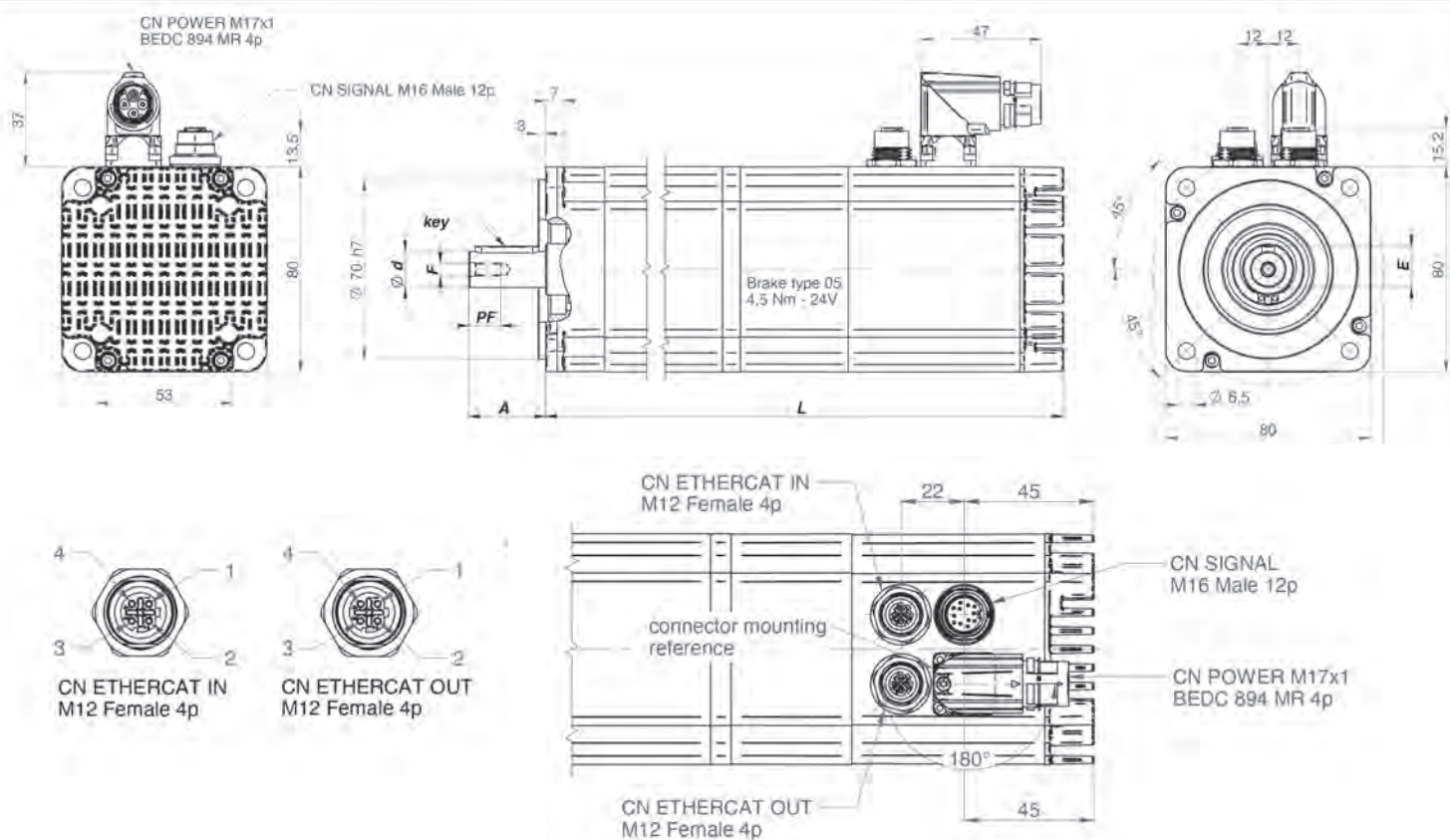

Dimensions in mm

SEE IT BEFORE IT HAPPENS

**MOTOR  
POWER**  
COMPANY

## DUET AD 80 DIMENSIONS (PROFINET MODEL)

		<b>DUET AD 80 1,5</b>	<b>DUET AD 80 2,8</b>
--	--	-----------------------	-----------------------

L (Without Brake)	mm	185	210
L (With Brake)	mm	227	252
A	mm	30	40
d	mm	14 (h6)	19 (h6)
ch	mm	5x5x25	6x6x30
F	mm	M5	M6
PF	mm	12,5	16
E	mm	16	21,5

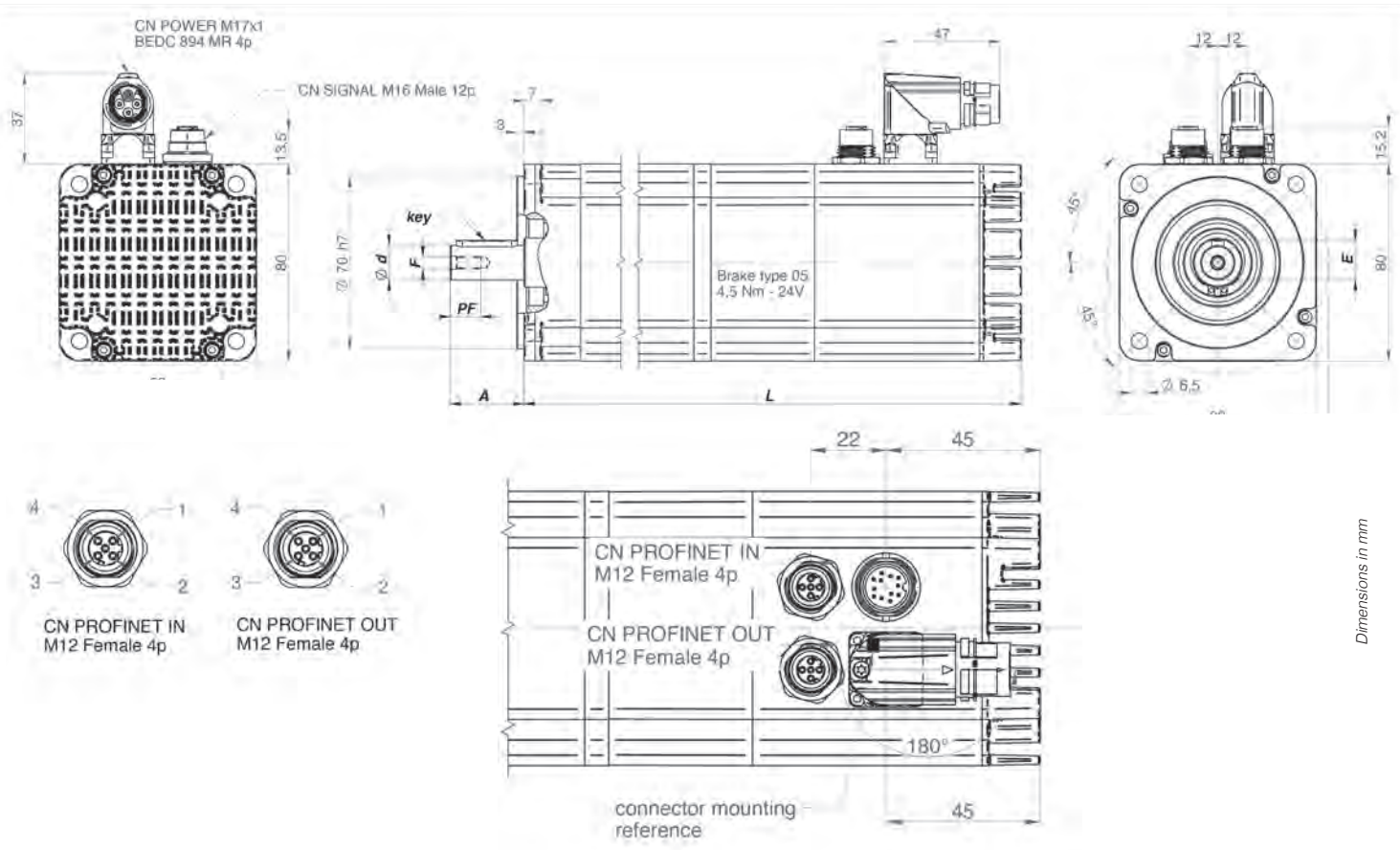

Dimensions in mm

SEE IT BEFORE IT HAPPENS



# DUET AD 80 TORQUE /SPEED CHARTS



## DUET AD 80 1,5 03

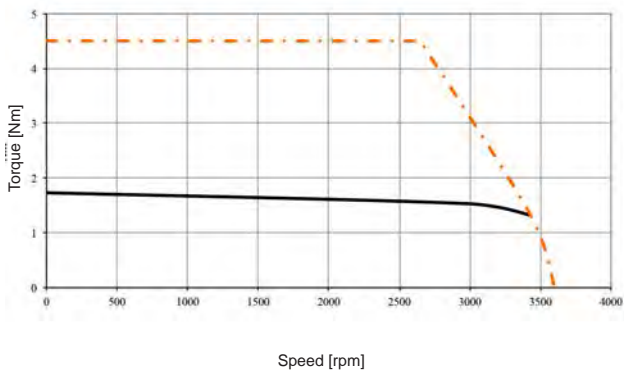

Continuous duty (S1) operation with cooling system appropriately sized.

## DUET AD 80 2,8 02

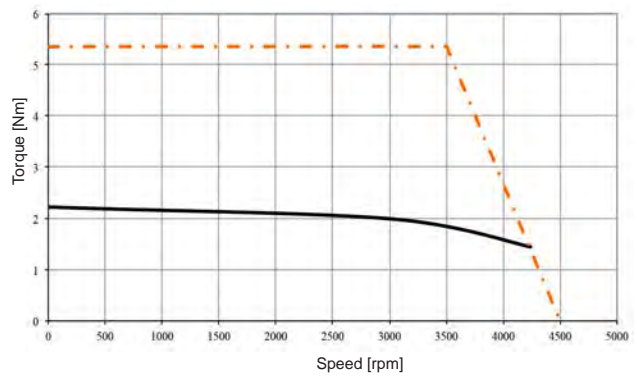

Continuous duty (S1) operation with cooling system appropriately sized.

SEE IT BEFORE IT HAPPENS



- Continuous duty @ rated voltage
- 24 Vdc
- 48 Vdc
- Continuous duty @ T(power stage) ≤50°C
- Continuous duty @ T(power stage) ≤70°C



# ***DUET HV***

***HIGH VOLTAGE INTEGRATED BRUSHLESS DRIVE***



## DUET HV 60 RATINGS AND SPECIFICATIONS

TIME RATING	Continuous	AMBIENT TEMPERATURE	0 to 40 °C
INSULATION CLASS	F	AMBIENT HUMIDITY	5 to 85% (non-condensing)
ENCLOSURE	Totally enclosed. Self-cooled	POLES	8
PROTECTION CLASS	IP 65 standard on the body	CE certified	
MOTOR INSULATION SYSTEM UL /CSA	cURus , DV155J File nr.:E216686		

### DUET HV 60 1,3 15

Rated Voltage	Vdc	560
Auxiliary Voltage (+6% -10%)	Vdc	24
Minimum Voltage	Vdc	275
Maximum Voltage	Vdc	740
Stall Torque	Nm	1,31
Peak Torque	Nm	3,9
Rated Torque	Nm	1,18
Rated Output Power	W	370
Stall Current	Arms	1,44
Peak Current	Arms	4,29
Rated Current	Arms	1,33
Rated Speed @560Vdc	rpm	3000
Maximum Speed @560Vdc	rpm	5000
Torque Constant ( $\pm 5\%$ )	Nm/Arms	0,91
Voltage Constant ( $\pm 5\%$ )	Vrms/Krpm	55
Phase/phase resistance ( $\pm 10\%$ @25°C)	Ohm	14,4
Phase/phase inductance ( $\pm 10\%$ )	mH	41,8
Electrical time constant	ms	2,90
Thermal Resistance	°C/W	1,41
Mechanical time constant	ms	0,63
Rotor Inertia (*)	Kg cm <sup>2</sup>	0,24
Duet weight	Kg	1,9
Duet weight with brake	Kg	2,33
Axial Load	N	70 (applied on the shaft's center)
Radial Load	N	220 (applied on the shaft's center)

Rated output with 250 x 250 x 6 mm metallic heat sink flange coupling - Derating must be considered if the oil seal is applied - IP 54 standard shaft bushing  
 (\*) without brake and without feedback

## DUET HV 80 RATINGS AND SPECIFICATIONS

TIME RATING	Continuous	AMBIENT TEMPERATURE	0 to 40 °C
INSULATION CLASS	F	AMBIENT HUMIDITY	5 to 85% (non-condensing)
ENCLOSURE	Totally enclosed. Self-cooled	POLES	8
PROTECTION CLASS	IP 65 standard on the body	CE certified	
MOTOR INSULATION SYSTEM UL /CSA	cURus , DV155J File nr.:E216686		

### DUET HV 80 2,8 17

### DUET HV 80 4 17

Rated Voltage	Vdc	560	560
Auxiliary Voltage (+6% -10%)	Vdc	24	24
Minimum Voltage	Vdc	275	275
Maximum Voltage	Vdc	740	740
Stall Torque	Nm	2,96	4
Peak Torque	Nm	8,4	12
Rated Torque	Nm	2,55	3,4
Rated Output Power	W	800	1068
Stall Current	Arms	1,75	2,50
Peak Current	Arms	5,8	7,50
Rated Current	Arms	1,64	2,19
Rated Speed @560Vdc	rpm	3000	3000
Maximum Speed @560Vdc	rpm	4000	4000
Torque Constant (± 5%)	Nm/Arms	1,6	1,6
Voltage Constant (± 5%)	Vrms/Krpm	97	96
Phase/phase resistance (± 10%@25°C)	Ohm	7,9	6,5
Phase/phase inductance (± 10%)	mH	35,4	28,6
Electrical time constant	ms	4,48	4,40
Thermal Resistance	°C/W	1,32	1,0
Mechanical time constant	ms	0,53	0,60
Rotor Inertia (*)	Kg cm <sup>2</sup>	1,16	1,58
Duet weight	Kg	4,1	5,1
Duet weight with brake	Kg	4,8	6,5
Axial Load	N	110 (applied on the shaft's center)	
Radial Load	N	350 (applied on the shaft's center)	

Rated output with 250 x 250 x 6 mm metallic heat sink flange coupling - Derating must be considered if the oil seal is applied - IP 54 standard shaft bushing  
(\*) without brake and without feedback

## DUET HV 100 RATINGS AND SPECIFICATIONS

TIME RATING	Continuous	AMBIENT TEMPERATURE	0 to 40 °C
INSULATION CLASS	F	AMBIENT HUMIDITY	5 to 85% (non-condensing)
ENCLOSURE	Totally enclosed. Self-cooled	POLES	8
PROTECTION CLASS	IP 65 standard on the body	CE certified	
MOTOR INSULATION SYSTEM UL /CSA	cURus , DV155J File nr.:E216686		

### DUET HV 100 5,6 17

### DUET HV 100 8 17

Rated Voltage	Vdc	560	560
Auxiliary Voltage (+6% -10%)	Vdc	24	24
Minimum Voltage	Vdc	275	275
Maximum Voltage	Vdc	740	740
Stall Torque	Nm	5,6	8
Peak Torque	Nm	22	22
Rated Torque	Nm	4,2	5
Rated Output Power	W	1320	1570
Stall Current	Arms	3,50	5
Peak Current	Arms	13,8	13,8
Rated Current	Arms	2,71	3,22
Rated Speed @560Vdc	rpm	3000	3000
Maximum Speed @560Vdc	rpm	4000	4000
Torque Constant (± 5%)	Nm/Arms	1,6	1,6
Voltage Constant (± 5%)	Vrms/Krpm	97	97
Phase/phase resistance (± 10%@25°C)	Ohm	3,64	2,2
Phase/phase inductance (± 10%)	mH	19,7	13,13
Electrical time constant	ms	5,4	6,0
Thermal Resistance	°C/W	0,95	0,78
Mechanical time constant	ms	0,62	0,53
Rotor Inertia (*)	Kg cm <sup>2</sup>	2,91	4,1
Duet weight	Kg	6,7	8,4
Duet weight with brake	Kg	7,9	9,6
Axial Load	N	225 (applied on the shaft's center)	
Radial Load	N	626 (applied on the shaft's center)	

Rated output with 300 x 300 x 6 mm metallic heat sink flange coupling - Derating must be considered if the oil seal is applied - IP 54 standard shaft bushing  
(\*) without brake and without feedback

## DUET HV 142 RATINGS AND SPECIFICATIONS

TIME RATING	Continuous	AMBIENT TEMPERATURE	0 to 40 °C
INSULATION CLASS	F	AMBIENT HUMIDITY	5 to 85% (non-condensing)
ENCLOSURE	Totally enclosed. Self-cooled	POLES	6
PROTECTION CLASS	IP 65 standard on the body	CE certified	
MOTOR INSULATION SYSTEM UL /CSA	cURus , DV155J File nr.:E216686		

### DUET HV 142 16,5 17

Rated Voltage	Vdc	560
Auxiliary Voltage (+6% -10%)	Vdc	24
Minimum Voltage	Vdc	275
Maximum Voltage	Vdc	740
Stall Torque	Nm	14
Peak Torque	Nm	42
Rated Torque	Nm	11,1
Rated Output Power	W	3500
Stall Current	Arms	8,7
Peak Current	Arms	26,2
Rated Current	Arms	7,3
Rated Speed @560Vdc	rpm	3000
Maximum Speed @560Vdc	rpm	3500
Torque Constant (± 5%)	Nm/Arms	1,6
Voltage Constant (± 5%)	Vrms/Krpm	97
Phase/phase resistance (± 10%@25°C)	Ohm	1,3
Phase/phase inductance (± 10%)	mH	6,9
Electrical time constant	ms	5,2
Thermal Resistance	°C/W	0,45
Mechanical time constant	ms	2,1
Rotor Inertia (°)	Kg cm <sup>2</sup>	27
Duet weight	Kg	19,5
Duet weight with brake	Kg	21,3
Axial Load	N	240 (applied on the shaft's center)
Radial Load	N	800 (applied on the shaft's center)

Rated output with 350 x 350 x 20 mm metallic heat sink flange coupling - Derating must be considered if the oil seal is applied - IP 54 standard shaft bushing  
 (\*) without brake and without feedback

SEE IT BEFORE IT HAPPENS

**MOTOR  
POWER**  
COMPANY

# DUET HV DIMENSIONS

## DUET HV 60

Type	DUET HV 60 1,3
Flange	60
Lenght L without brake (mm)	125
Lenght L with brake (mm)	162

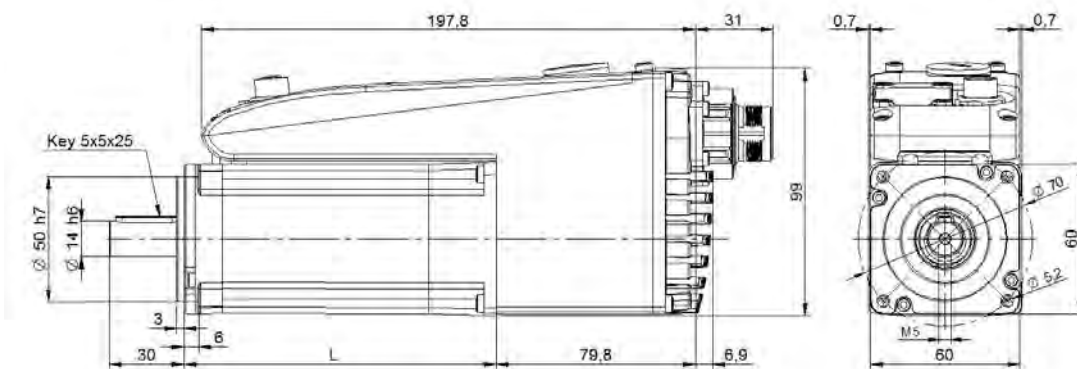

## DUET HV 80

Type	DUET HV 80 2,8	DUET HV 80 4
Flange	80	80
Lenght L without brake (mm)	115	140
Lenght L with brake (mm)	157	182

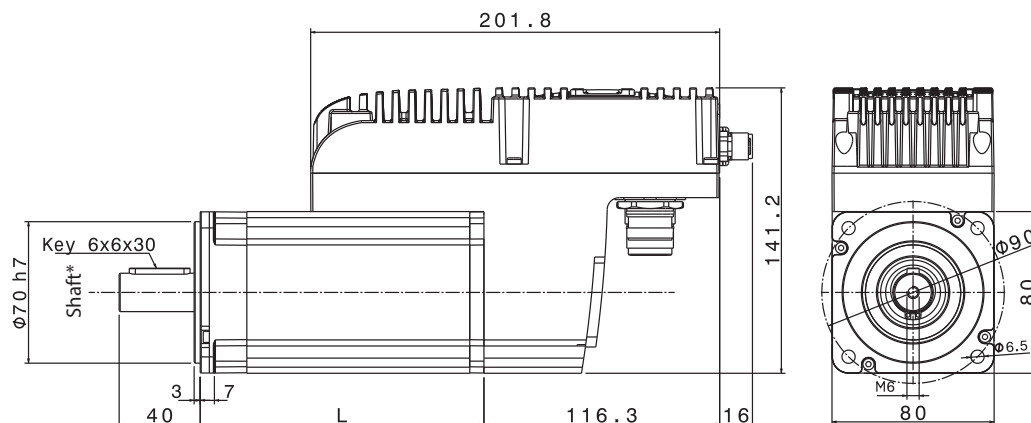

# DUET HV DIMENSIONS

## DUET HV 100

Type	DUET HV 100 5,6	DUET HV 100 8
Flange	100	100
Lenght L without brake (mm)	135	165,5
Lenght L with brake (mm)	186	216

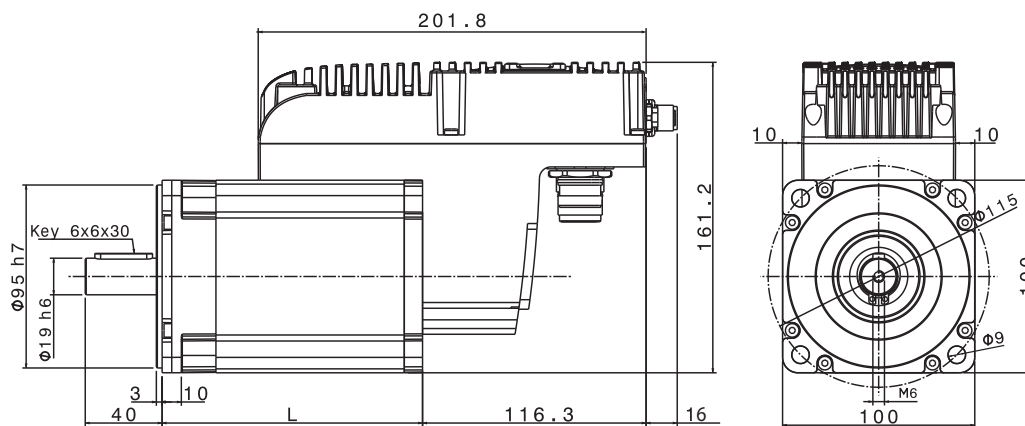

## DUET HV 142

Type	DUET HV 142 16,5
Flange	142
Lenght L without brake (mm)	271,5
Lenght L with brake (mm)	331,5

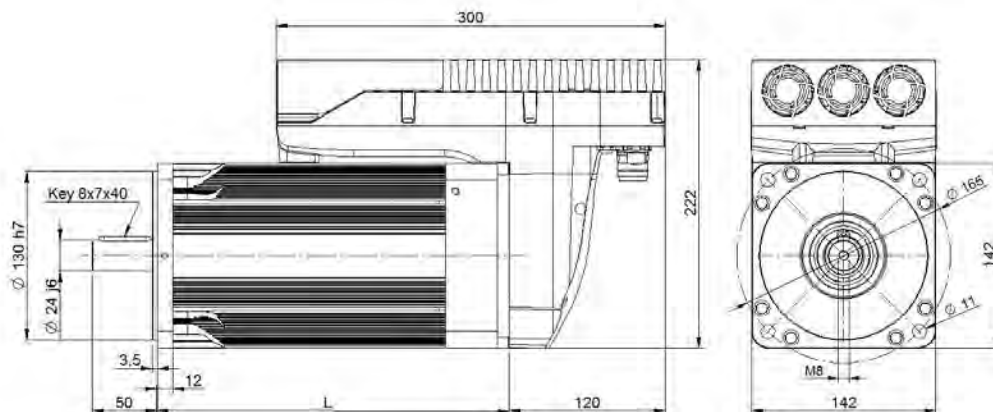

# DUET HV TORQUE /SPEED CHARTS

## DUET HV 60 1,3 15

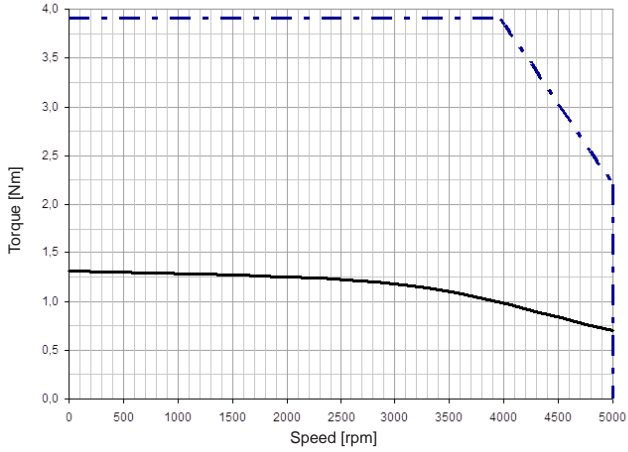

## DUET HV 80 2,8 17

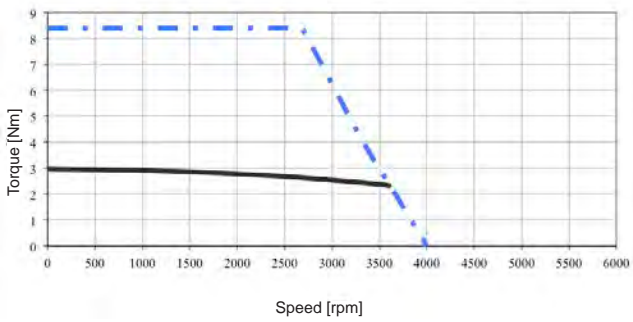

## DUET HV 80 4 17

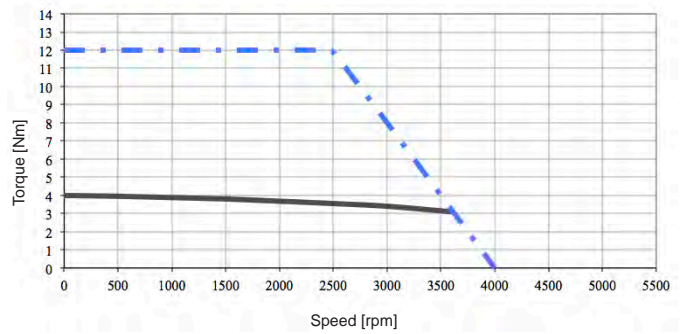

Continuous duty @ rated voltage  
 Cmax 560Vdc



# DUET HV TORQUE /SPEED CHARTS

## DUET HV 100 5,6 17

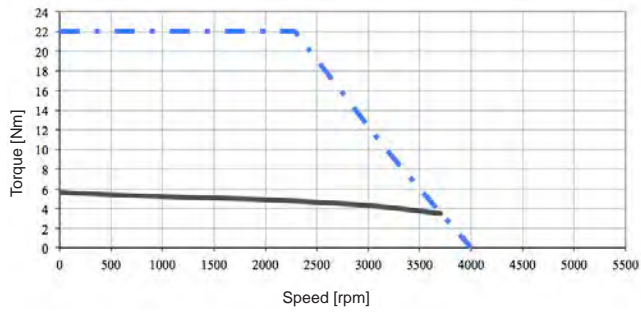

## DUET HV 100 8 17

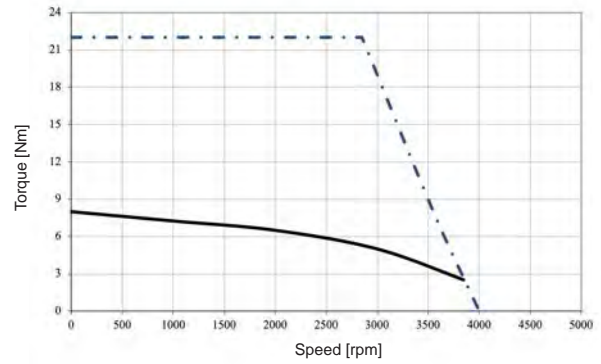

## DUET HV 142 16,5 17

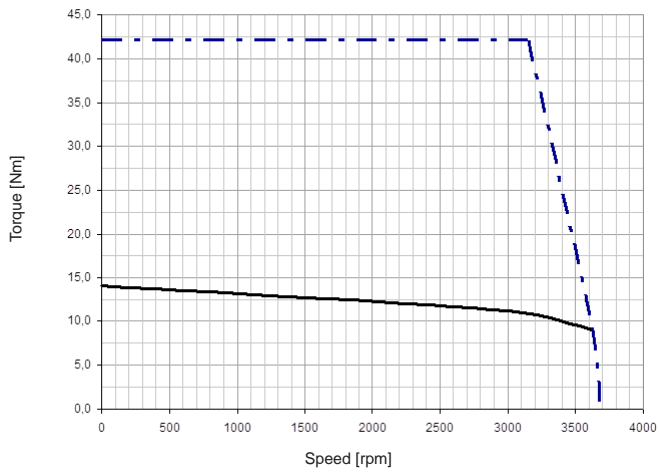

Continuous duty @ rated voltage  
 Cmax 560Vdc

# DUET WIRING CONNECTIONS

## POWER CONNECTOR

### for DUET 40

PIN	FUNCTION
1	+24 Vdc
2	0 Vdc
3	48 VP +
4	DOUT 0
5	DIN 1
6	DIN 2
7	PR
8	PE + Shield

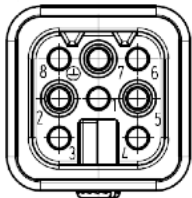

HAN 8D-M Male

### CAN IN

PIN	FUNCTION
1	Comret
2	-
3	Can-High
4	Can-Low

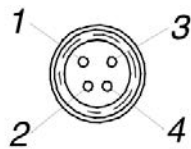

M8 Female

## SIGNAL CONNECTOR for DUET 40

### I/O

PIN	FUNCTION
1	0 Vdc
2	+24 Vdc
3	AIN 0 0-10 Vdc
4	DIN 0

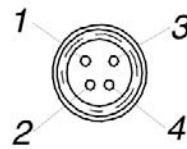

M8 Female

### CAN OUT

PIN	FUNCTION
1	Comret
2	-
3	Can-High
4	Can-Low

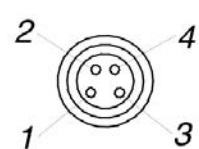

M8 Male

## POWER CONNECTOR

### for DUET 60

PIN	FUNCTION
1	+24 Vdc
2	0 Vdc
3	48 VP +
5	DOUT 1
6	DIN 1
7	PR
8	PE + Shield

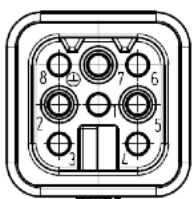

HAN 8D-M Male

### CAN IN

PIN	FUNCTION
1	Comret
2	-
3	Can-High
4	Can-Low

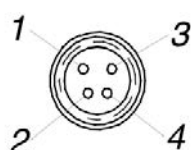

M8 Female

## SIGNAL CONNECTOR for DUET 60

### I/O

PIN	FUNCTION
1	0 Vdc
2	Analog - ( $\pm 10V$ )
3	Analog + ( $\pm 10V$ )
4	DIN 0

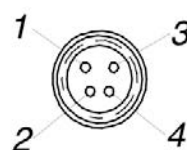

M8 Female

### CAN OUT

PIN	FUNCTION
1	Comret
2	-
3	Can-High
4	Can-Low

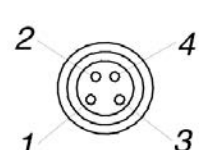

M8 Male

# DUET FLEXI WIRING CONNECTIONS

## POWER CONNECTOR

PIN	FUNCTION
1	+24 Vdc
2	0 Vdc
3	+48 Vdc
GND	Protective ground
A	Motor brake + (#)
B	Motor brake - (#)
C	- (#)
D	Drive brake out + (#)
E	Drive brake out - (#)

(#) Optional

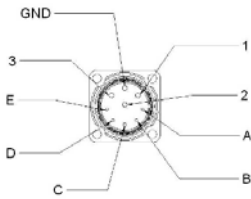

M17 BEGA 906 MR Male

## SIGNAL CONNECTOR

### RS 232

PIN	FUNCTION
1	Rx
2	Tx
3	Gnd
4	DIN7
Case	Shield



M8 Male

### CAN IN

PIN	FUNCTION
1	Shield
2	-
3	Can-Gnd
4	Can-high
5	Can-low

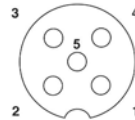

M12 Female

### CAN OUT

PIN	FUNCTION
1	Shield
2	-
3	Can-gnd
4	Can-high
5	Can-low

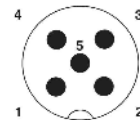

M12 Male

## POWER CONNECTOR

PIN	FUNCTION
1	+24 Vdc
2	0 Vdc
3	+48 Vdc
GND	Protective ground
A	Motor brake + (#)
B	Motor brake - (#)
C	- (#)
D	Drive brake out + (#)
E	Drive brake out - (#)

(#) Optional

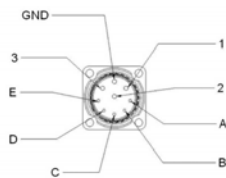

M17 BEGA 906 MR Male

## SIGNAL CONNECTOR

### RS 232

PIN	FUNCTION
1	Rx
2	Tx
3	Gnd
4	DIN7
Case	Shield

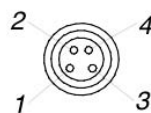

M8 Male

### ETHERCAT IN

PIN	FUNCTION
1	TD +
2	RD +
3	TD -
4	RD -
Case	Shield

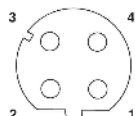

M12 Female

### ETHERCAT OUT

PIN	FUNCTION
1	TD +
2	RD +
3	TD -
4	RD -
Case	Shield

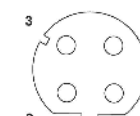

M12 Female

# DUET AD MODBUS WIRING CONNECTIONS

## POWER CONNECTOR

## SIGNAL CONNECTOR

### MODBUS RTU / RS485

PIN	FUNCTION
1	U power
2	Ballast
3	GND power
4	PE

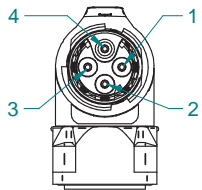

CN POWER M17x1 BEDC 894 MR 4p

PIN	FUNCTION
A	In 0
B	In 1
C	In 2
D	In 3
E	Out 1
F	Out 2
G	AI +
H	AI -
J	+24 Vdc
K	GND (OV)
L	Service -
M	Service +

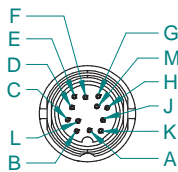

CN SIGNAL M16 Male 12 p

# DUET AD CANOPEN WIRING CONNECTIONS

## POWER CONNECTOR

PIN	FUNCTION
1	U power
2	Ballast
3	GND power
4	PE

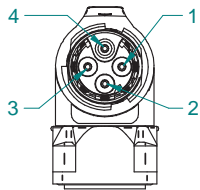

CN POWER M17x1 BEDC 894 MR 4p

## SIGNAL CONNECTOR

### CANOPEN

PIN	FUNCTION
A	In 0
B	In 1
C	In 2
D	In 3
E	Out 1
F	Out 2
G	AI +
H	AI -
J	+24 Vdc
K	GND (OV)
L	Service -
M	Service +

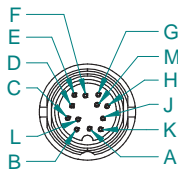

CN SIGNAL M16 Male 12p

PIN	FUNCTION
1	n.c.
2	n.c.
3	CAN-GDN
4	CAN-HIGH
5	CAN-LOW

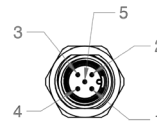

CN CAN  
M12 Male 5p

CN CANOPEN M12 Male 5p Type A

# DUET AD ETHERCAT WIRING CONNECTIONS

## POWER CONNECTOR

PIN	FUNCTION
1	U power
2	Ballast
3	GND power
4	PE

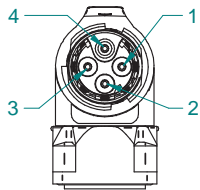

CN POWER M17x1 BEDC 894 MR 4p

## SIGNAL CONNECTOR

### ETHERCAT

PIN	FUNCTION
A	In 0
B	In 1
C	In 2
D	In 3
E	Out 1
F	Out 2
G	AI +
H	AI -
J	+24 Vdc
K	GND (OV)
L	Service -
M	Service +

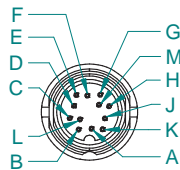

CN SIGNAL M16 Male 12p

PIN	FUNCTION
1	TD+
2	RD+
3	TD-
4	RD-

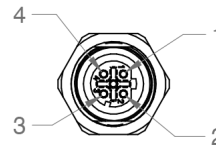

CN ETHERCAT M12 Female 4p Type D

# DUET AD PROFINET WIRING CONNECTIONS

## POWER CONNECTOR

## SIGNAL CONNECTOR

### PROFINET

PIN	FUNCTION
1	U power
2	Ballast
3	GND power
4	PE

PIN	FUNCTION
A	In 0
B	In 1
C	In 2
D	In 3
E	Out 1
F	Out 2
G	AI +
H	AI -
J	+24 Vdc
K	GND (OV)
L	Service -
M	Service +

PIN	FUNCTION
1	TX+
2	RX+
3	TX-
4	RX-

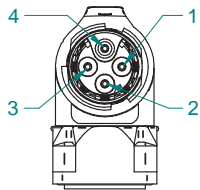

CN POWER M17x1 BEDC 894 MR 4p

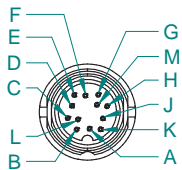

CN SIGNAL M16 Male 12p

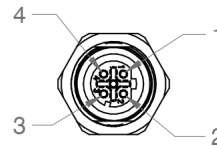

CN PROFINET M12 Female 4p Type D

# DUET HV 60 WIRING CONNECTIONS

## POWER CONNECTOR

**CN X1 PIN**                      **CN X1 DC power and logic supply**  
STO M23 Male Hummel 4p+3p+PE

1	HV-
2	PE
3	Not connected
4	HV+
A	/STO1
B	GND (24 Vdc return)
C	/STO2
D	CV (+24Vdc)
Case	PE



## SIGNAL CONNECTOR

**CN X4 PIN**                      **CN X4 auxiliary bus (RS232) Minidin Female, 6p**

1	Not connected
2	TX232
3	GND_COM
4	Not connected
5	Not connected
6	RX232
Case	PE

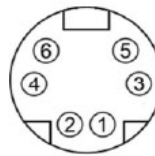

**CN X2 - X3 PIN**                      **CN X2 ETC out, CN X3 ETC in**  
M12, 4p female, D-code

1	TX Data+
2	RX Data +
3	TX Data -
4	RX Data -
Case	PE

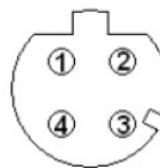

**CN X5 PIN**                      **CN X5 input/output**  
CN M12 female 4p, A-code

1	IN/OUT0
2	IN1
3	IN2
4	IN3
5	Not connected
6	OUT1
7	GND
8	OUT2
Case	PE

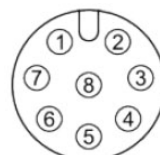



# DUET HV 80 -100 -142 WIRING CONNECTIONS

## POWER CONNECTOR

**CN5**  
PIN CN5 DC POWER AND LOGIC SUPPLY,  
STO, IN9 M23 Male Hummel 4p+3p+PE

1	HV-
3	NC
4	HV+
T	PE
A	/STO
B	GND_24
C	IN9
D	+24 Vdc
Case	PE

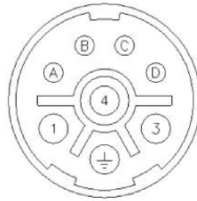

## SIGNAL CONNECTOR

**CN 1**  
PIN CN1 auxiliary Bus (RS232)  
CN M8 4p female

1	TX232
2	RX232
3	NC
4	GND_COM
Case	PE

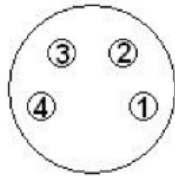

**CN 2 -3**  
PIN CN2 ETC out, CN3 ETC in  
M12 4p female D-code

1	TX Data +
2	RX Data +
3	TX Data -
4	RX Data -
Case	PE

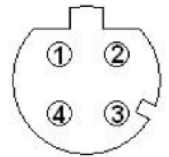

**CN4**  
PIN CN4 input/output  
CN M23 Male hummel 19p

1	IN/OUT 1-
2	IN/OUT 2-
3	AN_IN -
4	AN_IN +
5	IN/OUT 2+
6	GND_5V
7	+5 Vdc
8	IN 8
9	OUT 5
10	IN/OUT 3
11	IN 7
12	IN/OUT 0-
13	IN/OUT 0+
14	IN/OUT 1+
15	IN 4
16	OUT 4
17	OUT 6
18	IN 6
19	IN 5
Case	PE



80-100mm flange



142mm flange

# CABLES SPECIFICATIONS

## POWER CABLE for DUET

PIN	COLOUR	FUNCTION	For cable order	
1	Red	VL +		Length (mm)
2	Black	VL -		
3	Brown	VP +		Order code
4	Brown	Dout 0		003108020082
5	White	Din 1		
6	Blue	Din 2		
7	Blue	PR		
8	Sh + G/V	Sh + PE		

## POWER CABLE for DUET FLEXI

PIN	COLOUR	FUNCTION	For cable order	
1	Red	24V		Length (mm)
2	Blue	0V		
3	Brown	48V		Order code
4	Yellow/Green	GND		003108012049
A	White	Motor brake +		
B	Black	Motor brake -		
C	-	-		
D	Brown	Drive brake +		
E	Blue	Drive brake -		

## RS 232 CABLE for DUET FLEXI

M8 PIN	COLOUR	SUB-D 9 PIN	FUNCTION	For cable order	
1	Brown	3	Rx		Length (mm)
2	White	2	Tx		
3	Blue	5	Gnd		2000
4	Black	-	DIN7		3000
-	Shield	Metallic case	Shield		Order code
					003108009974
					003108009973
					003108009975

All cables are for static laying, power cables stand up to 10A stall current.  
For dynamic laying cables, please, contact our front office.

SEE IT BEFORE IT HAPPENS

**MOTOR  
POWER**  
COMPANY

# CABLES SPECIFICATIONS

## POWER CABLE for DUET AD

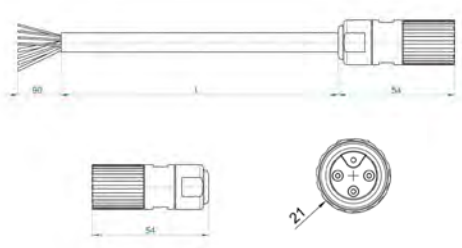
PIN	COLOUR	FUNCTION	For cable order		
1	Black 1	U Power		Length (mm)	Order code
2	Black 2	Ballast		1000	003108020575
3	Black 3	GND		5000	003108020546
4	Yellow/Green	Earth PE			
4	Shield	External cable shield			

## SIGNAL CABLE for DUET AD

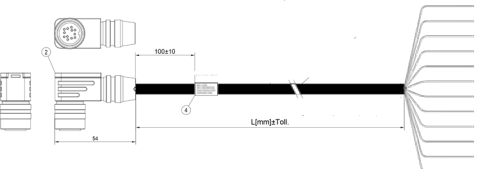
LM MOTOR SIDE	COLOUR	FUNCTION	For cable order		
A	White	IN0		Length (mm)	Order code
B	Brown	IN1		1000	003108020576
C	Green	IN2		5000	003108009843
D	Yellow	IN3			
E	Grey	OUT1			
F	Pink	OUT2			
G	Blue	AI+			
H	Red	AI-			
J	Brown/Green	Uc (24Vdc)			
K	White/Green	GND			
L	Black	Service-			
M	Violet	Service+			

SEE IT BEFORE IT HAPPENS

# CABLES SPECIFICATIONS

## I/O CABLE for DUET HV 80-100-142

PIN	COLOUR	FUNCTION	For cable order	
			Lenght (mm)	Order code
1	Brown	IN/OUT 1-		
2	Orange	IN/OUT 2-		
3	Grey	AN_IN-	1000	005108000505
4	White	AN_IN+	3000	005108000511
5	White	IN/OUT 2+	5000	005108000512
6	Blue	GND_5V	10000	005108000513
7	Red	+5V		
8	Red	IN8		
9	Red	OUT5		
10	Red	IN/OUT 3		
11	Red	IN 7		
12	Green	IN/OUT 0-		
13	White	IN/OUT 0+		
14	White	IN/OUT 1+		
15	Orange	IN 4		
16	Green	OUT 4		
17	Brown	OUT 6		
18	Grey	IN 6		
19	White	IN 5		
Case	Black	PE		



## POWER CABLE for DUET HV 80-100-142

PIN	WIRE IDENTIFICATION	FUNCTION	For cable order	
			Lenght (mm)	Order code
1	1	HV -		
3	3	NC		
4	2	HV +	1000	005108000504
T	Yellow/Green	PE	3000	005108000507
A	5	/STO	5000	005108000508
B	6	GND	10000	005108000509
C	7	IN9		
D	8	+24 V		
Case	Black	PE		



# CABLES SPECIFICATIONS

## RS 232 CABLE for DUET HV 80-100-142

PIN	COLOUR	FUNCTION	For cable order	
1	Red	TXT232	Lenght (mm) 1000	Order code 005108000506
2	Blue	RX232		
3	Brown	NC		
4	Yellow/Green	GND_COM		
Case	White	PE		



## ETHERCAT RJ45/M12 CABLE for DUET HV 80-100-142

RJ45 PIN	M12 PIN	FUNCTION	For cable order	
1	1	TX Data+	Lenght (mm) 10000	Order code 005108000500
3	2	RX Data +		
2	3	TX Data -		
6	4	RX Data -		
Case	Case	PE		



## ETHERCAT M12/M12 CABLE for DUET HV 80-100-142

PIN	FUNCTION	For cable order	
1	TX Data+	Lenght (mm) 3000 5000 10000	Order code 005108000503 005108000502 005108000501
2	RX Data +		
3	TX Data -		
4	RX Data -		
Case	PE		



SEE IT BEFORE IT HAPPENS

## FEEDBACK FEATURES FOR DUET

E1 TTL ENCODER	Motor size		DUET 40-60
	Nominal Voltage	V	5±10%
	Nominal current	mA	30
	Electronic type		LINE DRIVER AM 26 LS31
	Zero impulse		ONE AT A LAP
	N° of pulses revolution	ppr	1024
	Resolution	cpr	4096
	N° of commutation signal		3 (U, V, W)
	System accuracy	degree	± 0,5

## FEEDBACK FEATURES FOR DUET FLEXI

R1 RESOLVER 2 poles	Motor size		DUET FLEXI 60-80
	Nominal Voltage	Vrms	7±5%
	Nominal current	mA	50
	Phase shift		+3°
	Minimum sin amplitude	mVrms	20
	Frequency	kHz	10
	Poles number		2
	Trasformer ratio		0.5 ± 5%
	Input impedance	ohm	130 + j280
	Output impedance	ohm	425 + j755
	System accuracy		± 10'
	Rotor inertia	Kg cm <sup>2</sup>	0.03

A1 ABSOLUTE MULTITURN ENCODER	Motor size		DUET FLEXI 60 - 80
	Nominal Voltage	V	7 ÷ 12
	Maximum nominal current	mA	60
	Interface type		Hiperface
	N° absolute singleturn steps		4096 (12 Bits)
	N° absolute multiturn steps		4096 (12 Bits)
	N° of sin/cos periods per revolution		128
	Error limits for evaluating the sin/cos period	arc sec	± 80
	Rotor inertia	Kg cm <sup>2</sup>	0.0045

SEE IT BEFORE IT HAPPENS

## FEEDBACK FEATURES FOR DUET AD

<b>E6 ABSOLUTE SINGLETURN ENCODER</b>	Motor size		DUET AD 80
	Type		Magnetic encoder
	N° absolute single turn steps		16.384 (14 Bits)

## FEEDBACK FEATURES FOR DUET HV

<b>A1 ABSOLUTE MULTITURN ENCODER</b>	Motor size		DUET HV 60 - 80 - 100 - 142
	Nominal Voltage	V	7 ÷ 12
	Maximum nominal current	mA	60
	Interface type		Hiperface
	N° absolute singleturn steps		4096 (12 Bits)
	N° absolute multiturn steps		4096 (12 Bits)
	N° of sin/cos periods per revolution		128
	Error limits for evaluating the sin/cos period	arc sec	± 80
	Rotor inertia	Kg cm <sup>2</sup>	0.0045

<b>A3 ABSOLUTE MULTITURN ENCODER</b>	Motor size		DUET HV 60 - 80 - 100 - 142
	Nominal Voltage	V	7 ÷ 12
	Maximum nominal current	mA	50
	Interface type		Hiperface
	N° absolute singleturn steps		512 (9 Bits)
	N° absolute multiturn steps		4096 (12 Bits)
	N° of sin/cos periods per revolution		16
	Error limits for evaluating the sin/cos period	arc sec	± 288
	Rotor inertia	Kg cm <sup>2</sup>	0.001

<b>A5 ABSOLUTE SINGLETURN ENCODER</b>	Motor size		DUET HV 60 - 80 - 100 - 142
	Nominal Voltage	V	7 ÷ 12
	Maximum nominal current	mA	50
	Interface type		Hiperface
	N° absolute singleturn steps		512 (9 Bits)
	N° of sin/cos periods per revolution		16
	Error limits for evaluating the sin/cos period	arc sec	± 288
	Rotor inertia	Kg cm <sup>2</sup>	0.001

# BRAKE FEATURES

## DUET

		DUET 40 0,16	DUET 40 0,32	DUET 60 0,65 <sup>(*)</sup>	DUET 60 1,3 <sup>(*)</sup>
Static Torque @20°C	Nm	0,4	0,4	2	2
Moment of Inertia	Kg cm <sup>2</sup>	0,008	0,008	0,05	0,05
Rated Current	A	0,34	0,34	0,46	0,46
Input Power	W	8	8	11	11
Engaging Time	ms	6	6	6	6
Release Time	ms	10	10	25	25
Operating Voltage	24 Vdc +6% - 10% Stabilized				

<sup>(\*)</sup> Brake for DUET 60 is already parametrized by software function, any change to this parameter can compromise the brake operation

## DUET FLEXI / DUET AD

		DUET FLEXI 60 0,65	DUET FLEXI 60 1,3	DUET FLEXI 80 1,5 DUET AD 80 1,5	DUET FLEXI 80 2 DUET AD 80 2,8
Static Torque @20°C	Nm	2	2	4,5	4,5
Moment of Inertia	Kg cm <sup>2</sup>	0,05	0,05	0,22	0,22
Rated Current	A	0,46	0,46	0,5	0,5
Input Power	W	11	11	12	12
Engaging Time	ms	6	6	7	7
Release Time	ms	25	25	35	35
Operating Voltage	24 Vdc +6% - 10% Stabilized				

## DUET HV

		DUET HV 60 1,3	DUET HV 80 2,8	DUET HV 80 4	DUET HV 100 5,6	DUET HV 80 2,8	DUET HV 142 16,5
Static Torque @20°C	Nm	2	4,5	4,5	9	9	18
Moment of Inertia	Kg cm <sup>2</sup>	0,050	0,22	0,22	0,80	0,80	1,9
Rated Current	A	0,46	0,5	0,5	0,75	0,75	1
Input Power	W	11	12	12	18	18	24
Engaging Time	ms	6	7	7	7	7	10
Release Time	ms	25	35	35	40	40	50
Operating Voltage	24 Vdc +6% - 10% Stabilized						



## CONNECTOR SPECIFICATIONS

### FLYING CONNECTORS for DUET

Power connector  
HAN Female M 250V/10A 3x1,5mm<sup>2</sup>+5x.0,14mm<sup>2</sup>

order code 007117000804

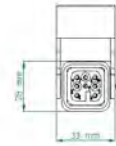
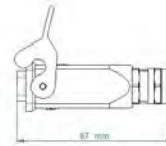

### FLYING CONNECTORS for DUET FLEXI

Power connector  
BSTA 908FR1186201A000 4+5p/FM

order code 005117001105

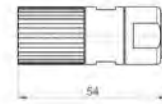

### FLYING CONNECTORS for DUET AD

Power connector BSTA896FR0985202A000 4p/M17

order code 005117000356

Signal connector M16 12P FM 99 5630 75 12

order code 005117002496

Can Open connector M12 5P. FM IN PLASTICA 8A5000-325

order code 005117000580

### TERMINAL CONNECTORS for DUET

M8 male CAN IN terminal connector 120Ω

order code 005117000970

M8 female CAN OUT terminal connector 120Ω

order code 005117000972

### TERMINAL CONNECTORS for DUET FLEXI

M12 male CAN IN terminal connector 120Ω

order code 005803000256

M12 female CAN OUT terminal connector 120Ω

order code 005803000701

SEE IT BEFORE IT HAPPENS

**MOTOR  
POWER**  
COMPANY

# CONNECTORS AND ACCESSORIES

## FLYING CONNECTORS for DUET HV

M23 Female 180° power connector	order code 005117001854
M23 Female 90° power connector	order code 005117001855
M23 Female 180° I/O connector	order code 005117001852
M23 Female 90° I/O connector	order code 005117001853
M12 Male 180° Ethercat connector	order code 005117001850
M12 Male 90° Ethercat connector	order code 005117001851

## CAPS for CONNECTORS for DUET HV

Cap for M23	order code 005803000272
Cap for M23 IP65	order code 005803000274
Cap for M12 Ethercat	order code 005803000270

## POWER SUPPLIES for DUET HV

DPS 20 (20 Amp)	order code 005016001062
DPS 40 (40 Amp)	order code 005016001064

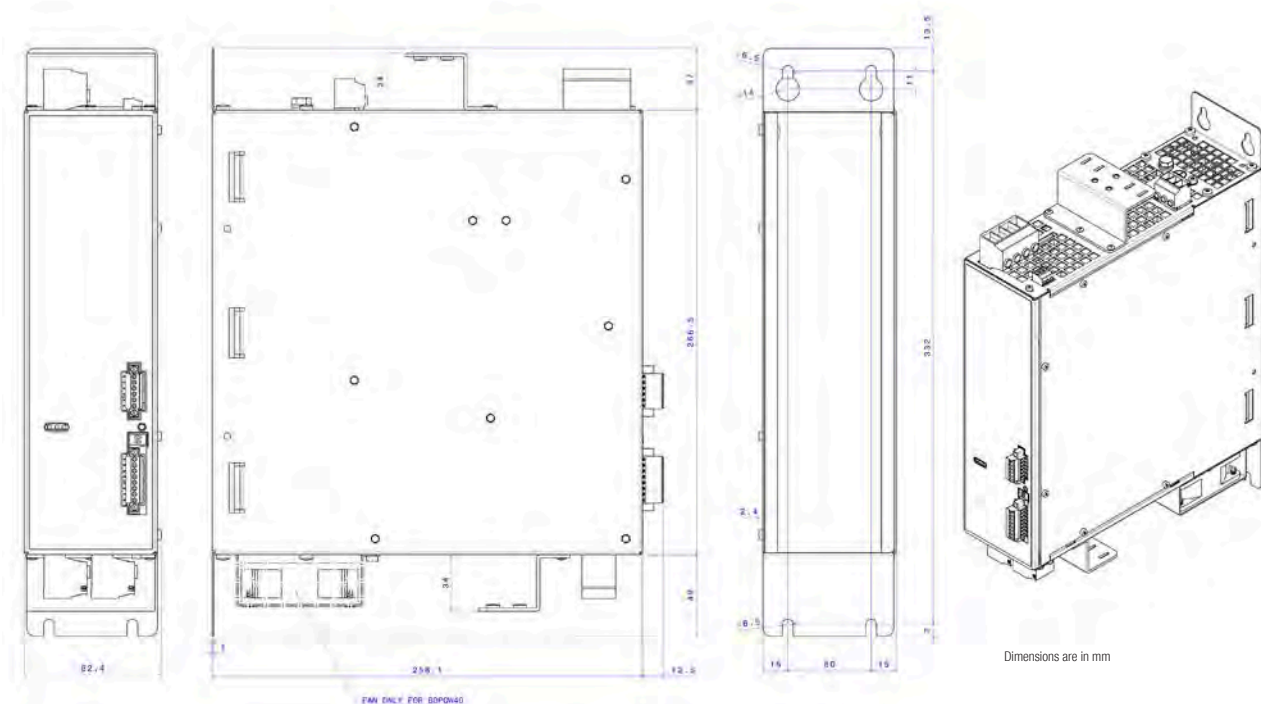

Motor Power Company  
www.motorpowerco.com  
info@motorpowerco.it

All rights reserved.  
Complete or partial reproduction  
is not allowed without our permission.

All technical data in this catalog  
may be changed without prior notice.

[motorpowerco.com](http://motorpowerco.com)

**MOTORS**

**MOTION CONTROL**

**MECHATRONICS**

**MOTOR  
POWER**  
COMPANY

**Motor Power Company s.r.l.**

Via Leonardo Da Vinci, 4  
42024 Castelnovo Sotto  
Reggio Emilia - Italia  
Tel. 0039 0522 682710  
Fax 0039 0522 683552  
[info@motorpowerco.it](mailto:info@motorpowerco.it)

**Motor Power Company GmbH**

Dillberg, 11  
97828 Marktheidenfeld  
Germany  
Tel 0049 9391 9198905  
Fax 0049 9391 9198907  
[info@motorpowerco.de](mailto:info@motorpowerco.de)

**Motor Power Company Asia Ltd.**

Workshop 7, Shiny Science Park No.  
111, Dong Ting North Rd.  
215400 Taicang, Jiangsu Province  
P.R.China  
Tel + 86-512-33337978  
Fax +86-512-53207871  
[infoasia@motorpowerco.com](mailto:infoasia@motorpowerco.com)